

930A COMMUNICATIONS TEST SET



Sage Instruments
930A Communications Test Set

Operations Manual

REVISION 3.2 9/20/92

SOFTWARE VERSIONS 3.28 AND ABOVE

SAGE INSTRUMENTS
240 AIRPORT BLVD.
FREEDOM, CA 95019-2614
(408)761-1000

TABLE OF CONTENTS

| <u>SECTION</u> | <u>TITLE</u> | <u>PAGE</u> |
|-----------------------------------|---|-------------|
| I GENERAL INFORMATION | | |
| 1-1 | Introduction | 1-1 |
| 1-2 | Specifications | 1-1 |
| 1-3 | Description | 1-1 |
| 1-4 | A Word About Softkey Controlled Test Sets | 1-5 |
| 1-5 | Accessories Available | 1-6 |
| 1-6 | Warranty | 1-6 |
| II INSTALLATION | | |
| 2-1 | Introduction | 2-1 |
| 2-2 | Initial Inspection | 2-1 |
| 2-3 | Preparation For Use | 2-1 |
| 2-4 | Operating Environment | 2-3 |
| 2-5 | Storage And Shipment | 2-3 |
| 2-6 | Physical Description | 2-5 |
| III BASIC ANALOG OPERATION | | |
| 3-1 | Introduction | 3-1 |
| 3-2 | Getting The 930A To Do What You Want | 3-1 |
| 3-2.1 | When first turning on the 930A | 3-2 |
| 3-2.2 | How to cold boot the 930A | 3-3 |
| 3-3 | Front Panel Controls, Indicators and Connectors | 3-4 |
| 3-3.1 | How To Use The Numeric Keypad | 3-5 |
| 3-3.2 | How To Use The Special Function Keys | 3-6 |
| 3-3.2.1 | How To Store Settings And Test Set-Ups | 3-7 |
| 3-3.2.2 | Details Of The Store Feature | 3-7 |
| 3-3.2.3 | How To Recall What You Have Stored | 3-9 |
| 3-3.2.4 | Example Of Storing And Recalling | 3-10 |
| 3-3.2.5 | How To Enter And Clear Data | 3-13 |
| 3-3.2.6 | How To Use The Help Key | 3-14 |
| 3-3.3 | Using The Hook Switch To Seize And Release Trunks | 3-14 |
| 3-4.1 | How To Select The Trunk Type | 3-15 |

SECTION III BASIC ANALOG OPERATION (CONTD)

| <u>SECTION</u> | <u>TITLE</u> | <u>PAGE</u> |
|----------------|--|-------------|
| 3-4.2 | How To Set-Up A Trunk Type | 3-16 |
| 3-4.2.1 | EXAMPLE: Setting Up An E&M Trunk | 3-16 |
| 3-4.3 | Where To Find Optional Trunk Types | 3-19 |
| 3-4.4 | SF Supervision | 3-20 |
| 3-4.5 | Basic Test Functions | 3-22 |
| 3-4.6 | How To Connect Test Cords to the 930A | 3-24 |
| 3-5 | How To Place A Call Using The Dial/Ring Function | 3-24 |
| 3-5.1 | Details Of Dial/Ring Operation | 3-26 |
| 3-5.2 | How To Store And Recall Phone Numbers | 3-28 |
| 3-5.3 | Transmission Level Point (TLP) Compensation | 3-29 |
| 3-6 | How to measure Return Loss with the 930A | 3-30 |
| 3-6.1 | Details of Key operation in Return Loss | 3-31 |
| 3-6.2 | Trans Hybrid loss and how to measure it | 3-33 |
| 3-7 | How To Send A Tone From The 930A | 3-34 |
| 3-7.1 | Details Of The Send Tone Function | 3-36 |
| 3-8 | How To Measure The Level And Frequency Of Tones | 3-38 |
| 3-8.1 | Details Of Key Operation In Measure Tone | 3-39 |
| 3-9 | How To Measure Noise And Signal-To-Noise | 3-40 |
| 3-9.1 | Example Of Measuring Signal-To-Noise | 3-41 |
| 3-9.2 | Details Of Key Operation In Measure Nois | 3-42 |
| 4-0 | Wideband Analog Operation | 3-43 |
| 4-1 | Introduction | 3-43 |
| 4-2 | Setup Procedure | 3-43 |
| 4-3 | Wideband Operation | 3-45 |
| 4-3.1 | Transmission Level Point (TLP) Compensation | 3-45 |
| 4-3.2 | How to Measure Return Loss with the 930A in Wideband | 3-46 |
| 4-3.4 | How to send tone from the 930A in Wideband | 3-46 |
| 4-3.5 | Measuring tone with the 930A in Wideband | 3-47 |
| 4-3.6 | How to measure tone with the 930A in Wideband | 3-48 |
| 4-4.1 | Extended Features/Options Functionality | 3-49 |
| 4-4.1 | Option Menu 10 - Sweep | 3-49 |
| 4-4.2 | Option Menu 11 - Impulse Noise and Hits | 3-55 |

SECTION IV BASIC PCM OPERATION

| <u>SECTION</u> | <u>TITLE</u> | <u>PAGE</u> |
|----------------|---|-------------|
| 4-1 | The T-1 PCM Trunk Type Interface (Option 930A-08E or -09E) | 4-1 |
| 4-1.1 | How To Change PCM Channels And Test Direction..... | 4-3 |
| 4-1.2 | How To Change The PCM Default Settings | 4-6 |
| 4-2 | How To Monitor A T-1 Span..... | 4-11 |
| 4-3 | How To Monitor Both Directions On A T-1 Span..... | 4-13 |
| 4-4 | Terminating A T-1 Span For Out-Of-Service Testing | 4-14 |
| 4-5 | Drop and Insert Testing on a T-1 Line..... | 4-18 |
| 4-6 | How To Define Your Own ON/OFF-HOOK States..... | 4-23 |
| 4-7 | How To Select Foreign Exchange Supervision | 4-26 |
| 4-8 | Drop And Insert Test Cord Connections At A T-1 CSU..... | 4-30 |

SECTION V EXTENDED FEATURES/OPTIONS

| <u>SECTION</u> | <u>TITLE</u> | <u>PAGE</u> |
|----------------|---|-------------|
| 5-0 | Extended Features/Menu Options..... | 5-1 |
| 5-0.1 | Finding what you want under the Option Menu key | 5-1 |
| 5-0.2 | Useful Trunk Type/Menu Option Combinations | 5-1 |
| 5-0.3 | How to get into the Menu once you find it..... | 5-5 |
| 5-1 | Changing the Dial/Ring Defaults (Menu Option 1) | 5-7 |
| | MF Or DTMF Digits..... | 5-8 |
| 5-1.2 | Changing the Level, Frequency and Timing or MF or DTMF Digits..... | 5-8 |
| 5-1.3 | How To Change The %Break, Rate And Interdigit Time Of Dial Pulse (DP) Digits | 5-11 |
| 5-1.4 | Modification of Ring Generator Parameters | 5-13 |
| 5-2 | How To Build A Call Sequence (Menu Option 2) | 5-15 |
| 5-2.1 | How To Build A Feature Group D Sequence In The 930A..... | 5-15 |
| 5-2.2 | How To Place A Call On A Wink Start Trunk..... | 5-24 |
| 5-2.3 | How To Send A Call More Than 18 Digits Long..... | 5-28 |
| 5-2.4 | Additional Features Of Menu Option 2..... | 5-29 |
| 5-2.5 | ROTL/Responder Testing Using Send Digit Sequences | 5-32 |
| 5-3 | Setting-Up The Print Function (Menu Option 3) | 5-35 |
| 5-4 | Digit Receiver/Analyzer (Menu Option 4) | 5-38 |
| 5-4.1 | How To Receive Calls On PBX Or POTS Trunks..... | 5-45 |
| 5-4.2 | Receiving Calls On PBX Ground Start Trunks..... | 5-51 |
| 5-4.3 | Receiving An Equal Access Call Sequence On A T-1 PCM Channel..... | 5-56 |
| 5-4.4 | Using The Digit Receiver Scan Mode..... | 5-62 |
| 5-4.5 | More About Equal Access Calls..... | 5-63 |
| 5-4.6 | Responder Testing Using The Digit Receiver..... | 5-65 |
| 5-5 | The Ring Generator And REN-3 Load (Menu Option 5)..... | 5-72 |
| 5-6 | How To Use The DC Voltmeter (Menu Option 6)..... | 5-76 |
| 5-7 | How To Change The Supervision Voltage Thresholds (Menu Option 7) | 5-80 |
| 5-7.1 | Supervision Threshold Ranges | 5-81 |
| 5-7.2 | How To Work With 24 Volt Supervision..... | 5-83 |
| 5-7.3 | Change Loop Supervision Thresholds | 5-83 |
| 5-7.4 | How To Change Ground Start Thresholds..... | 5-86 |
| 5-7.5 | How To Change E&M Supervision Thresholds..... | 5-88 |
| 5-8 | Measuring Supervision Event Times (Menu Option 8)..... | 5-92 |
| 5-8.1 | Monitoring Ground Start Supervision..... | 5-96 |
| 5-8.2 | Measuring A/B/C/D Bit Supervision On PCM Channels..... | 5-96 |
| 5-9 | How To Measure Wink Timing (Menu Option 9)..... | 5-100 |
| 5-10 | Using The Frequency Sweep (Menu Option 10)..... | 5-102 |

SECTION V EXTENDED FEATURES/OPTIONS (CONTD)

| <u>SECTION</u> | <u>TITLE</u> | <u>PAGE</u> |
|----------------|---|-------------|
| 5-11 | Measuring 3-Level Impulse Noise (Menu Option 11)..... | 5-112 |
| 5-11.1 | Phase Hits, Gain Hits and Dropouts | 5-121 |
| 5-12 | To Margin The Wink Duration Of The 930A (Menu Option 12) | 5-123 |
| 5-13 | Phase/Amplitude Jitter and Hits (Menu Option 13) | 5-126 |
| 5-13.1 | To Measure Phase/Amplitude Jitter | 5-126 |
| 5-14 | Setting the Time and date (Menu Option 14) | 5-129 |
| 5-15 | How To Stop The 930A From Beeping (Menu Option 15) | 5-131 |
| 5-16 | Digit Receiver Timeout (Menu Option 16) | 5-133 |
| 5-17 | Envelope Delay Distortion (Menu Option 17) | 5-134 |
| 5-17.1 | Measuring Envelope Delay Distortion..... | 5-135 |
| 5-17.2 | EDD Measurement In The SEND Mode | 5-139 |
| 5-17.3 | EDD Measurement In The Repeat Or Slave Mode..... | 5-143 |
| 5-18 | Peak To Average Ratio (P/AR) (Menu Option 18) | 5-146 |
| 5-19 | Intermodulation Distortion (Menu Option 19) | 5-149 |
| 5-19.1 | Making A 4-Tone IMD Test On a Four-Wire Circuit..... | 5-154 |
| 5-20 | To Check A/B/C/D Bit States On All 24 Channels (Menu Option 20) | 5-158 |
| 5-21 | To Manually Toggle The A/B/C/D Bits Or View Both Directions Simultaneously (Menu Option 21) | 5-160 |
| 5-22 | (Menu Option 22) Absolute Delay Operation..... | 5-163 |
| 5-25 | ROTL/Responder/Interrogator Menu Option 25 | 5-167 |
| 5-26 | Using The 930A As A ROTL/Near-End Responder (Menu Option 26) | 5-171 |
| 5-27 | Using The 930A To Interrogate A ROTL (Menu Option 27) | 5-179 |
| 5-27.1 | Entering The ROTL Priming Digits..... | 5-181 |
| 5-28 | Testing To Type 125 Transponders (Menu Option 28) | 5-183 |
| 5-28 | How To Set Up Transponder Test | 5-183 |
| 5-28.2 | How To Test To A Type 125 Transponder..... | 5-186 |
| 5-29 | Calling A 102 Test Line (Menu Option 29) | 5-193 |
| 5-30 | How To Change The TLP (Menu Option 30) | 5-198 |
| 5-31 | How To Send A Hook Flash (Menu Option 31) | 5-201 |
| 5-32 | Using The Dial-Up Testline (Menu Option 32) | 5-203 |
| 5-33 | Using The Dial-Up Sweep (Menu Option 33) | 5-206 |
| 5-35 | Sending Dial-Tone, Busy and Other Dual Tone Signals (Menu Option 35) | 5-208 |
| 5-37 | Line Status (Menu Option 37) | 5-213 |

SECTION V EXTENDED FEATURES/OPTIONS (CONTD)

| <u>SECTION</u> | <u>TITLE</u> | <u>PAGE</u> |
|----------------|--|-------------|
| 5-37.1 | Operational Procedures | 5-213 |
| 5-39 | (Menu Option 39) Remote Audio Monitor Operation | 5-214 |
| 5-40 | How To Send PCM Alarms And Force Frame Slips (Menu Option 40) | 5-218 |
| 5-41 | How To Measure The T-1 Voltage At The DSX Jacks (Menu Option 41) | 5-222 |
| 5-42 | How To Detect T-1 Wander Or Clock Difference (Menu Option 42) | 5-225 |
| 5-43 | How To Measure Frame Slips, BPVs And Other Errors With The 930A (Menu Option 43) | 5-228 |
| 5-44 | T-1 Error History (Menu Option 44) | 5-232 |
| 5-45 | How To Inject A BPV Or Frame Error (Menu Option 45) .. | 5-236 |
| 5-46 | DS-1 Bit Error Rate Testing With The 930A (Menu Option 46) | 5-239 |
| 5-46.1 | Bit Error Testing Using The 930A | 5-239 |
| 5-46.2 | How To Change Test Patterns, Framing And Other Parameters | 5-243 |
| 5-46.3 | BER Testing T1 facilities with the 930A | 5-249 |
| 5-46.4 | Testing Toward A T-1 CSU With The 930A | 5-251 |
| 5-46.5 | BER Testing Two T-1 Spans Simultaneously | 5-255 |
| 5-46.6 | How To Send Errors And Select Other Types | 5-257 |
| 5-47 | Testing A T-1 Automatic Protection Switch (APS) (Menu Option 47) | 5-259 |
| 5-48 | CSU Emulation (Menu Option 48) | 5-262 |
| 5-48.1 | Description and Operation | 5-262 |
| 5-50 | Batch Mode Testing With The 930A (Menu Option 50) | 5-269 |
| 5-50.1 | How Batch Mode works | 5-269 |
| 5-50.2 | Batch Mode Capabilities and Examples | 5-270 |
| 5-50.3 | Key Functions In Batch Mode | 5-272 |
| 5-50.4 | Possible Events In The Call Sequence | 5-274 |
| 5-50.5 | Batch Mode Example | 5-280 |
| 5-50.6 | Testing Using Batch Mode | 5-281 |
| 5-51 | Storing test results (Menu Option 51) | 5-283 |
| 5-51.1 | How to check the setup information | 5-286 |
| 51.2 | Storing and Recalling test results | 5-288 |
| 5-52 | E-911 PSAP Simulator (Menu Option 52) | 5-292 |
| 5-52.1 | 930A Operational procedures | 5-293 |
| 5-56 | DS-0 Bit Error Rate Testing (BERT) With The 930A (Menu Option 56) | 5-302 |

SECTION V EXTENDED FEATURES/OPTIONS (CONTD)

| <u>SECTION</u> | <u>TITLE</u> | <u>PAGE</u> |
|----------------|--|-------------|
| 5-56.1 | How to setup the 930A for DS-0 BER Testing | 5-303 |
| 5-56.2 | DS-0 BER Testing..... | 5-308 |
| 5-56.3 | Point-to-Point DS0 BER Testing Using Two 930As | 5-308 |
| 5-56.4 | Loopback BER Testing on 56 KBps DDS [®] Trunks | 5-310 |
| 5-57 | How To Make The 930A Give A Loopback (Menu Option 57) | 5-314 |
| 5-65 | The 930A To Work On Ground Start Coin Phone Trunks (Menu Option 65) | 5-316 |
| 5-87 | TPT Burst length (Menu Option 87) | 5-318 |
| 5-88 | How To Change Post-Test Progress Tone Delay (Menu Option 88) | 5-319 |
| 5-89 | Printer Handshake (Menu Option 89) | 5-320 |
| 5-90 | DSP Memory Test (Menu Option 90) | 5-322 |
| 5-91 | Where To Find The Software Version (Menu Option 91) | 5-323 |
| 5-92 | How To Do A Software Cold-Boot (Menu Option 92) | 5-324 |
| 5-93 | The Test Display (Menu Option 93) | 5-325 |
| 5-94 | How To Find Out What Options Are Installed In Your 930A (Menu Option 94) | 5-325 |
| 5-95 | How To Test Dry Circuits With The 930A (Menu Option 95) | 5-327 |

SECTION VI REMOTE CONTROL FEATURES

| <u>SECTION</u> | <u>TITLE</u> | <u>PAGE</u> |
|----------------|---|-------------|
| 6-1 | Introduction | 6-1 |
| 6-1.1 | Selecting The Remote Mode | 6-3 |
| 6-1.2 | Setting The Serial Interface Format | 6-4 |
| 6-2 | Using The 930A In The Printer Mode | 6-8 |
| 6-2.1 | Introduction | 6-8 |
| 6-2.2 | Setting up the print function | 6-9 |
| 6-2.3 | Printer handshake | 6-12 |
| 6-2.4 | Printer Applications | 6-13 |
| 6-2.4 | Printer Report Formats | 6-14 |
| 6-3 | Operation in the Terminal Mode | 6-16 |
| 6-3.1 | Terminal Set-Up | 6-17 |
| 6-3.2 | Terminal Keys | 6-19 |
| 6-3.3 | Terminal CRT Display | 6-21 |
| 6-3.4 | Troubleshooting | 6-22 |
| 6-4 | Computer Operation | 6-23 |
| 6-4.1 | Introduction | 6-23 |
| 6-4.2 | Setting Up The Computer Mode | 6-26 |
| 6-4.3 | Input to the 930A | 6-28 |
| 6-4.4 | Output From the 930A | 6-28 |
| 6-4.5 | Display Line Formats | 6-29 |
| 6-4.6 | Programmers Notes | 6-32 |
| 6-4.6.1 | Initializing The 930A | 6-32 |
| 6-4.6.2 | Using The HELP Menus | 6-34 |
| 6-4.6.3 | When Does The 930A Send A Bell? | 6-41 |

LIST OF TABLES

| TABLE | TITLE | PAGE |
|-------|---|------|
| 1-1 | Specifications | 1-7 |
| 5-1 | Option Menu Numbers | 5-3 |
| 6-1 | ASCII to Front Panel Key Conversions | 6-25 |
| 6-2 | Special ASCII Characters For Remote Control | 6-26 |

LIST OF ILLUSTRATIONS

| <u>FIGURE</u> | <u>TITLE</u> | <u>PAGE</u> |
|---------------|---|-------------|
| 1-1 | Model 930A and Accessories | 1-4 |
| 2-1 | SAGE Instruments Model 930A | 2-2 |
| 2-2 | Model 930A Front Panel | 2-4 |
| 2-3 | Configurator Panels | 2-6 |
| 2-4 | Model 930A Rear Panel | 2-8 |
| 2-5 | Model 930A Interior View | 2-10 |
| 3-1 | Front Panel Layout | 3-4 |
| 4-1 | Monitoring in one direction on a T-1 | 4-11 |
| 4-2 | Dual direction monitoring with the 930A | 4-13 |
| 4-3 | Terminating a T-1 span for out of service testing | 4-16 |
| 4-4 | Preperation for dual direction Drop and Insert | 4-19 |
| 4-5 | Test cord connections for Drop and Insert testing | 4-21 |
| 4-6 | Dual Drop and Insert | 4-23 |
| 4-7 | CSU Block diagram | 4-31 |
| 4-8 | Test cord connection at T-1 CSU | 4-32 |
| 4-9 | CSU In and Equipment jacks | 4-33 |
| 4-10 | CSU Drop and Insert | 4-35 |
| 5-1 | T-1 supervision event timing with the 930A | 5-96 |

LIST OF ILLUSTRATIONS (CONTD)

| <u>FIGURE</u> | <u>TITLE</u> | <u>PAGE</u> |
|---------------|--|-------------|
| 5-2 | Step by Step Office Mini ROTL Priming digit format | 5-189 |
| 5-3 | No. 5 ESS Priming chart..... | 5-190 |
| 5-4 | Step by Step Office Expanded Format..... | 5-190 |
| 5-5 | No. 1 ESS ROTL Priming Digits Format..... | 5-191 |
| 5-6 | No. 4 ESS ROTL Priming Digits Format..... | 5-191 |
| 5-7 | GTD-5 ITT 1210 Priming Digits Format..... | 5-192 |
| 5-8 | DMS100/200 ROTL Priming Digits Format..... | 5-192 |
| 5-9 | Remote Audio Operation | 5-216 |
| 5-10 | Sending alarms or forcing slips from the 930A | 5-217 |
| 5-11 | Measuring T-1 voltage at the DSX Monitor Jack | 5-221 |
| 5-12 | 930A Connected for Wander Measurement | 5-225 |
| 5-13 | Test cord connections for Error Monitoring | 5-227 |
| 5-14 | Monitoring in both directions..... | 5-231 |
| 5-15 | Injecting errors with the 930A | 5-235 |
| 5-16 | Test cord connections for Single direction BERT | 5-240 |
| 5-17 | Test cord connections for Dual direction BERT | 5-241 |
| 5-18 | Two T-1 spans being BER tested simultaneously | 5-254 |
| 5-19 | Simultaneous BER toward two offices | 5-255 |
| 5-20 | DS0 BERT Test configuration | 5-302 |
| 5-21 | DS0 BERT Drop and Insert | 5-303 |
| 5-22 | DS0 BERT with two 930A Test Sets | 5-308 |
| 5-23 | Loopback BER Setup | 5-309 |
| 6-1 | RS232 Connector connection | 6-1 |
| 6-2 | RS232 Connector Pinouts..... | 6-2 |
| 6-3 | Terminal CRT Display | 6-19 |

LIST OF MENU OPTION NUMBERS

| <u>MENU OPTION NUMBER</u> | <u>DESCRIPTION</u> | <u>PAGE</u> |
|---------------------------|--------------------------------|-------------|
| OPTION NUMBER: 1 | MODIFY DIAL/RING | 5-7 |
| OPTION NUMBER: 2 | SEND DIGIT SEQUENCES..... | 5-14 |
| OPTION NUMBER: 3 | REMOTE CONTROL..... | 5-34 |
| OPTION NUMBER: 4 | DIGIT RECEIVER..... | 5-37 |
| OPTION NUMBER: 5 | REN-3 LOAD | 5-71 |
| OPTION NUMBER: 6 | D.C. MULTIMETER..... | 5-75 |
| OPTION NUMBER: 7 | SUPERVISION THRESHOLDS | 5-79 |
| OPTION NUMBER: 8 | SUPERVISION MONITOR | 5-91 |
| OPTION NUMBER: 9 | WINK TIMING..... | 5-99 |
| OPTION NUMBER: 10 | FREQUENCY SWEEP | 5-102 |
| OPTION NUMBER: 11 | IMPULSE NOISE & HITS..... | 5-112 |
| OPTION NUMBER: 12 | WINK MARGINING | 5-123 |
| OPTION NUMBER: 13 | PHASE/AMPLITUDE JITTER..... | 5-126 |
| OPTION NUMBER: 14 | SET TIME AND DATE..... | 5-129 |
| OPTION NUMBER: 15 | BEEP ON ERROR..... | 5-131 |
| OPTION NUMBER: 16 | DIGIT RECEIVER TIMEOUT..... | 5-133 |
| OPTION NUMBER: 17 | ENVELOPE DELAY DISTORTION..... | 5-134 |
| OPTION NUMBER: 18 | PEAK/AVERAGE RATIO..... | 5-146 |
| OPTION NUMBER: 19 | 4-TONE INTERMODULATION | 5-149 |
| OPTION NUMBER: 20 | 24 BIT DISPLAY..... | 5-158 |
| OPTION NUMBER: 21 | TOGGLE A/B BITS | 5-160 |
| OPTION NUMBER: 22 | ABSOLUTE DELAY | 5-163 |
| OPTION NUMBER: 23 | RESERVED | N/A |
| OPTION NUMBER: 24 | RESERVED | N/A |
| OPTION NUMBER: 25 | FAR END RESPONDER | 5-167 |
| OPTION NUMBER: 26 | ROTL/NEAR END RESPONDER..... | 5-171 |
| OPTION NUMBER: 27 | ROTL INTERROGATOR | 5-179 |
| OPTION NUMBER: 28 | TRANSPONDER TEST..... | 5-183 |
| OPTION NUMBER: 29 | CALL 102 LINE | 5-193 |
| OPTION NUMBER: 30 | ADJUST TLP..... | 5-199 |
| OPTION NUMBER: 31 | SEND HOOK FLASH..... | 5-202 |
| OPTION NUMBER: 32 | DIAL-UP TESTLINE..... | 5-204 |
| OPTION NUMBER: 33 | DIAL-UP SWEEP..... | 5-206 |
| OPTION NUMBER: 34 | SELECT REPORTS | N/A |
| OPTION NUMBER: 35 | DUAL TONE SENDER..... | 5-208 |
| OPTION NUMBER: 37 | LINE STATUS | 5-213 |
| OPTION NUMBER: 39 | REMOTE AUDIO | 5-214 |
| OPTION NUMBER: 40 | SEND PCM ALARMS | 5-217 |
| OPTION NUMBER: 41 | READ T1 VOLTAGE..... | 5-221 |

LIST OF MENU OPTION NUMBERS

| <u>MENU OPTION NUMBER</u> | <u>DESCRIPTION</u> | <u>PAGE</u> |
|---------------------------|--------------------------|-------------|
| OPTION NUMBER: 42 | T1 WANDER | 5-217 |
| OPTION NUMBER: 43 | ERROR COUNTERS..... | 5-220 |
| OPTION NUMBER: 44 | T1 ERROR HISTORY..... | 5-224 |
| OPTION NUMBER: 45 | T1 ERROR INJECT..... | 5-228 |
| OPTION NUMBER: 46 | DS-1 BIT ERROR RATE..... | 5-231 |
| OPTION NUMBER: 47 | APS TEST..... | 5-251 |
| OPTION NUMBER: 48 | CSU EMULATION..... | 5-254 |
| OPTION NUMBER: 50 | BATCH MODE..... | 5-261 |
| OPTION NUMBER: 51 | TEST REPORTS..... | 5-275 |
| OPTION NUMBER: 52 | E911..... | 5-284 |
| OPTION NUMBER: 56 | DS-0 BIT ERROR RATE..... | 5-294 |
| OPTION NUMBER: 57 | DS-0 LOOPBACK..... | 5-306 |
| OPTION NUMBER: 65 | GND-ST COIN PHONE..... | 5-308 |
| OPTION NUMBER: 87 | TPT BURST LENGTH..... | 5-310 |
| OPTION NUMBER: 88 | POST-TPT DELAY..... | 5-311 |
| OPTION NUMBER: 89 | PRINTER HAND SHAKE..... | 5-312 |
| OPTION NUMBER: 90 | DSP MEMORY TEST..... | 5-314 |
| OPTION NUMBER: 91 | SOFTWARE VERSION..... | 5-315 |
| OPTION NUMBER: 92 | SOFTWARE COLD-BOOT..... | 5-316 |
| OPTION NUMBER: 93 | TEST DISPLAY..... | 5-317 |
| OPTION NUMBER: 94 | LIST OPTIONS..... | 5-318 |
| OPTION NUMBER: 95 | DRY CIRCUIT..... | 5-320 |
| OPTION NUMBER: 96 | TEST EXTENDED RAM..... | N/A |
| OPTION NUMBER: 97 | HOLD CONTROL..... | N/A |

SECTION I

GENERAL INFORMATION

1-1 INTRODUCTION

This operating manual contains general information regarding the installation and operation of the SAGE Model 930A Communications Test Set. Figure 1-1 shows the instrument and optional accessories available.

1-2 SPECIFICATIONS

The instrument specifications are listed in Table 1-1. These specifications are the performance standards or limits against which the instrument is tested. Options for the instrument have separate specifications which are provided on supplementary specification sheets.

1-3 DESCRIPTION

The Model 930A Communications Test Set combines the functions of a Transmission Impairment Set, a Return Loss Measurement Set, Dial Pulse, Touch Tone (DTMF) and Multi-Frequency (MF) Sender, and Talk Battery supply into one lightweight package. Hardware and software options allow the user to greatly increase the capabilities of the 930A. These options include:

- DP, DTMF, MF Receiver/Analyzer with Trunk Simulation
- SF Supervision
- P/AR Receiver/Transmitter
- 3-Level Impulse Noise
- RS-232C Remote Control/Printer Interface
- DS-1 PCM Transmit/Receive (Single or Dual-Direction)
with D4/Superframe, Extended Superframe and SLC-96 Capability
- Type 105 ROTL/Interrogator/Responder (52A Format)
- Ring Generator/REN-3 Load
- LTTP/STTP Interface (#1/1A ESS Switch)
- FXO/FXS Supervision
- Phase/Amplitude Jitter and Hits Measurement
- Non-Linear Distortion Measurement
- Envelope Delay Distortion Measurement
- DS-0/DS-1 Bit Error Rate Testing
- Enhanced 911 PSAP Simulation

The Model 930A performs the three basic functions required of a **DEMARC** test set in today's environment. These are: Transmission Measurements, Signaling and Supervision, and T-1 PCM Drop/Insert (optional) testing.

The Model 930A has been designed to access and perform tests on the following types of circuits:

- Equal Access (Feature Group D)
- Centralized Automatic Message Accounting (CAMA)
- Traffic Service Position System (TSPS)
- Toll
- International Direct Distance Dialing (IDDD)
- Data
- PBX
- Private Line Automatic Ringdown (PLAR)
- Manual Ringdown (MRD)
- Foreign Exchange Office and Station ends (FXO/FXS) (optional)
- DS-1 PCM Single Direction D4 Superframe and ESF (optional)
- DS-1 PCM Dual-Direction Drop/Insert D4 Superframe and ESF (optional)

The Model 930A can simulate the telephone company central office or the terminating end of the circuit (Customer Provided Equipment, an Inter-LATA carrier, DEMARC, or Point of Presence).

Section V of this manual describes the operation of the Options you may have purchased for the 930A.

The transmission measurements which the 930A can make are:

1. Level and Frequency
2. Noise (C-MSG, C-Notch, 3 kHz Flat and Signal-to-Noise)
3. Noise-to-Ground
4. Noise with Tone
5. Return Loss (2-Wire and 4-Wire)
6. DC Voltage and Current
7. P/AR (Option 930A-06)
8. 3-Level Impulse Noise & Hits (Option 930A-07 & -18)
9. Phase/Amplitude Jitter (Option 930A-18)
10. 4-Tone Intermodulation Distortion (Option 930A-20)
11. Envelope Delay Distortion (Option 930A-19)

The signaling and supervision simulation capabilities of the Model 930A are:

1. 2- and 4-wire Loop Start (Normal and Reverse)
2. Ground Start (Normal and Reverse)
3. E&M signaling Types I, II, III, IV and V
4. Wink Start
5. Multi-Wink/Multi-Stage (Feature Group D, TSPS, etc.)
6. Delay Dial
7. SX supervision
8. DP, DTMF, and MF signaling sender
9. DP, DTMF, and MF Receiver/Analyzer (Option 930A-01)
10. SF supervision (Option 930A-02)
11. T1 (Robbed Bit signaling) (Option 930A-08E or -09E)
12. FXO/FXS supervision on PCM trunks (Option 930A-25)
13. Enhanced 911 PSAP Simulation (Option 930A-37)

The Model 930A can also establish the talk path condition for transmission testing and has the ability to hold circuits for testing.

The T1 facility testing capabilities of the 930A are:

1. Send and Receive patterns for DS-0/DS-1 Bit Error Rate Testing (Option 930A-22)
2. Count Slips, BPVs, Frame Errors and Losses, CRC Errors (Option 930A-08E or -09E)
3. Provide detailed error history (Option 930A-22)
4. Measure T1 voltage at the DSX (Option 930A-08E or -09E)
5. A, B, C & D Bit Timing (Option 930A-08E or -09E)
6. Test Automatic Protection Switches (APS) (Option 930A-22)
7. Emulate CSU on a T1 facility (Option 930A-44)

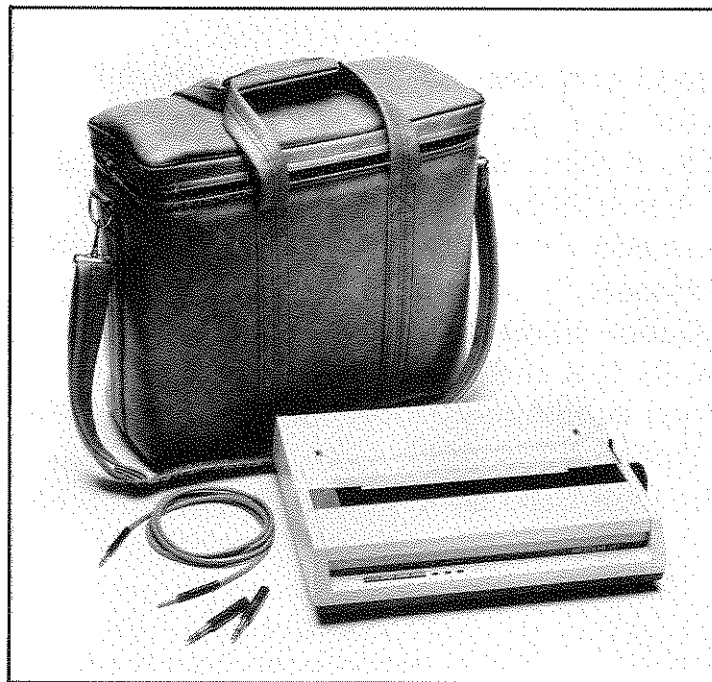
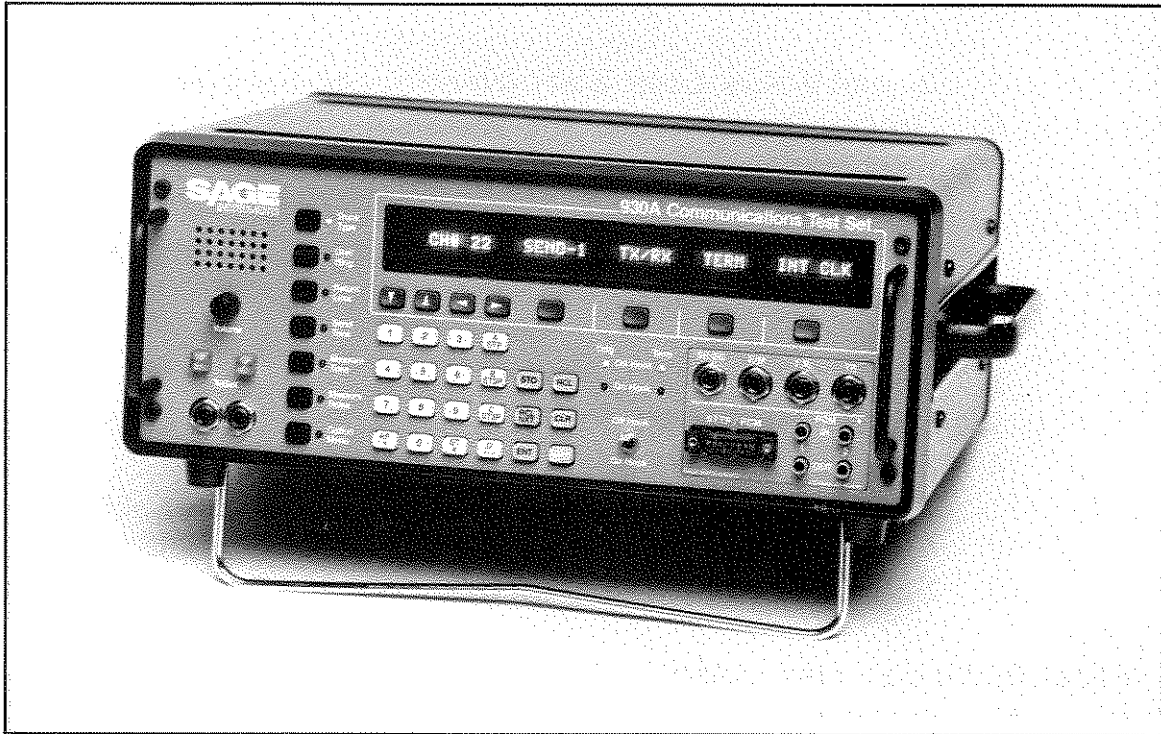

**MODEL 930A AND ACCESSORIES
FIGURE 1-1**

1-4 A WORD ABOUT SOFTKEY CONTROLLED TEST SETS

As you can see from glancing at Figure 1-1, the 930A front panel has push-buttons for everything. With all microprocessor controlled equipment, you have the advantage of placing a lot of functions into one compact package. You have to get used to using a single front panel to operate what, in the old days, was four or more separate instruments. In order to accomplish this feat, and still have a reasonably sized instrument, a bit of ingenuity is required. Most manufacturers, SAGE included, have chosen to use the "softkey" approach.

What this means is that the four unlabeled keys, directly below the display, and to the right of the arrow keys, change their definition with each new display. **The display above the key** at any particular time defines that key's function at that instant.

In the 930A, every attempt has been made to have the unit operate in a logical manner. For example, when you turn on the 930A, the first thing it does is power-up to the last trunk type you selected. It wants to give you the opportunity to change to another trunk type. Since the 930A operates on so many different trunk types and it can simulate either the office or subscriber ends of each type, this is a valid question. Also, the 930A sets many of its defaults, such as Transmission Level Points (TLP), depending on the trunk type you select.

The layout of the front panel is intended to be logical so the major functions (Trunk Type, Dial/Ring, etc.) are grouped separately from the Numeric Keypad and the Special Function keys. Once the desired function key has been pressed and the LED beside it lights, control within that function passes to the arrow keys and softkeys under the display.

If you keep this in mind, learning and using the 930A will be a bit easier. Just in case, there is a front panel **HELP** key which provides step-by-step prompts for operating each function (except the **OPTION MENU** Function key). The display will have a flashing cursor over the currently selected parameter for each step. If you want that particular choice, press the softkey under it. If you do not want it, press the softkey under the choice you do want. The screen will advance to the next item for you to select, and so on, until the function has been set up. The display will then return to the function's main screen.

1-5 ACCESSORIES AVAILABLE

The following accessories are available:

1. 80 Column Dot Matrix Printer and Cable,
SAGE P/N 9400-0001-01
2. Test Cord, bantam male to bantam male, 96 inches
SAGE P/N 9400-0002-01
3. Adapter , 310 male to bantam female,
SAGE P/N 9400-0003-01
4. Test Cord, 310 male to 310 male, 60 inches
SAGE P/N 9400-0004-01
5. Test Cord, 310 male to alligator clip, 60 inches
SAGE P/N 9400-0005-01
6. Test Cord, 310 male to bantam male, 96 inches
SAGE P/N 9400-0006-01
7. Test Cord, 310 male to RJ-11, 96 inches
SAGE P/N 9400-0008-01
8. Test Cord, 310 male to DEMARC Clip, 96 inches
SAGE P/N 9400-0009-01
9. Standard 19-inch rack mounting kit,
SAGE P/N 9400-1001-01
10. Standard 23-inch rack mounting kit,
SAGE P/N 9400-1002-01
11. Padded Vinyl Carrying Case,
SAGE P/N 9400-1003-01
12. Industrial Grade Shipping Case,
SAGE P/N 9400-1004-01
13. Front Panel Cover,
SAGE P/N 9400-1005-01
14. Calibration Kit
SAGE P/N 9400-0012-01

1-6 WARRANTY

Warranty information is listed on the inside of the front cover.

TABLE 1-1 *Specifications***LEVEL/FREQUENCY****TRANSMITTER**

| | |
|------------------|---|
| Frequency Range: | 20 Hz to 5000 Hz, 20Hz to 300KHz |
| Resolution: | 1 Hz |
| Accuracy: | 1.0 Hz |
| Output Steps: | 1 Hz, 10 Hz, 100 Hz, or 1000 Hz steps |
| Frequency Sweep: | Single or Continuous with selectable bounds, level and step size. |
| Level Range: | - 60 dBm to + 12 dBm |
| Resolution: | 0.1 dB |
| Accuracy: | 0.1 dB @ 1004 Hz (0 to -19 dBm), |
| Flatness: | 0.2 dB (200 Hz to 5 kHz referenced to level at 1 KHz) |
| Distortion: | - 70 dB @ 1004 Hz, 0 dBm |

RECEIVER

| | |
|------------------|--|
| Frequency Range: | 20 Hz to 5000 Hz, 20Hz to 300KHz |
| Resolution: | 1 Hz |
| Accuracy: | 1.0 Hz |
| Level Range: | - 50 dBm to + 12 dBm |
| Resolution: | 0.1 dB |
| Accuracy: | 0.1 dB @ 1004 Hz (0 to -19 dBm), 0.2 dB @ 200 Hz to 5 khz |

NOISE MEASUREMENTS

| | |
|--------------------|---|
| Input: | Balanced or Noise-to-Ground |
| Weighting Filters: | C-MSG, C-NOTCH,3 KHz Flat15K,PROG,50K |
| Notch Filter: | 1010 Hz (995 Hz to 1025 Hz Notch); > 60 dB Notch depth |
| Range: | 10 dBrn to 100 dBrn (Balanced) 50 dBrn to 130 dBrn (Noise-to-Ground) |
| Resolution: | 1.0 dB |
| Accuracy: | 0.5 dB |

TABLE 1-1 Specifications (con't)**SIGNAL-TO-NOISE MEASUREMENT**

| | |
|--------------|--------------------|
| Level Range: | -50 dBm to +10 dBm |
| Noise Range: | 10 dBm to 90 dBm |
| S/N Range: | 10 dB to 50 dB |
| Accuracy: | 0.5 dB |
| Resolution: | 1.0 dB |

RETURN LOSS MEASUREMENT

| | |
|---------------------|--|
| Modes: | ERL, SRL-Low, SRL-High or Sinewave (OSCillator mode) |
| Transmitted Signal: | Meets the specifications of Bell Publication 41009 (Tables D, E and F, page 13) and IEEE Standard 743-1984 |

2-WIRE RETURN LOSS

| | |
|----------------------------|--|
| Transmitter Level: | -10 dBm0 |
| Receiver Range: | 0 dB to 40 dB |
| Resolution: | 1.0 dB |
| Accuracy: | 0.5 dB |
| Internal Hybrid Impedance: | 600 or 900 Ohms 0.1% in series with 2.16 uF 1% |

4-WIRE RETURN LOSS

| | |
|--------------------------------|--|
| Impedance: | 150, 600, 900, or 1200 Ohms |
| Transhybrid Loss Compensation: | - 30 dB to + 30 dB |
| Transmitter Level: | - 10 dBm0 In OSCillator mode the level is 0 dBm relative to the TLP |
| Receiver Range: | -10 dB to 50 dB |
| Resolution: | 1.0 dB |
| Accuracy: | 0.5 dB |

TABLE 1-1 *Specifications (con't)***SUPERVISORY SIGNALING****WINK TIMING**

Resolution: 5 msec.
 Accuracy: 5 msec.
 Wink Fail Event: Fails for wink period >600 msec.
 Off-Hook Fail Event: Fails for Off-Hook period <600 msec.

E/M SUPERVISION

Types: I, II, III, IV, V
 Battery: - 48 VDC current limited to 200 mA
 Threshold Voltages:

| | <u>E Lead</u> | <u>M Lead</u> |
|----------|---------------|---------------|
| On-hook | < - 16 V. | > - 16 V. |
| Off-hook | > - 16 V. | < - 16 V. |

LOOP SUPERVISION

Types: 2- and 4-wire Loop Start, Ground Start, Loop Reverse Battery, and SX supervision.
 Battery: - 48 VDC series limited to 120 mA

MF AND DTMF SENDER

Frequency Accuracy: 0.1% of Bell Standard Frequencies
 Adjustment Range: Tone Frequencies adjustable in 0.1% steps to 10% of standard Bell frequencies for Margin Testin.
 Level: Automatically adjusted to -7 dBm0
 Level Adjustment Range: Tone level adjustable in 0.1 dB steps from - 60.0 dBm to + 6.0 dBm

TABLE 1-1 Specifications (con't)

| | |
|--------------------------|--|
| Resolution: | 0.1 dB |
| Accuracy: | 0.2 dB |
| Timing: | MF: 70 ms Tone On and Tone Off (KP is 100 mS Tone On) |
| Timing Adjustment Range: | DTMF: 50 ms Tone On and Tone Off Tone On and Tone Off times adjustable in 1 ms steps from 13 msec. to 267 msec. |
| Resolution: | 1 msec. |
| Accuracy: | 1.0 msec. |

DIAL PULSE SENDER**PPS**

| | |
|-------------|----------------|
| Range: | 2 to 50 PPS |
| Resolution: | 0.1 PPS |
| Accuracy: | 1.0% at 10 PPS |

% BREAK

| | |
|-------------|----------------------------------|
| Range: | 5 to 95% |
| Resolution: | 0.1% |
| Accuracy: | 1.0% for 25% to 75% BRK @ 10 PPS |

INTERDIGIT TIMING

| | |
|-------------|-----------------|
| Range: | 40 to 990 msec. |
| Resolution: | 10 msec. |
| Accuracy: | 5 msec. |

TABLE 1-1 *Specifications (con't)***GENERAL**

| | |
|------------------------|--|
| Impedances: | 150, 600, 900, 1200 Ohms and > 50 KOhms Bridging |
| Maximum DC Blocking: | 160 VDC |
| Audio Bandwidth: | 3.0 dB 300 Hz to 3.0 kHz |
| Audio Volume: | Adjustable by front panel control |
| Longitudinal Balance: | 90 dB at 60 Hz |
| Receiver Return Loss: | > 30 dB 200 Hz to 5 kHz (600, 900, 1200 Ohms) > 30 dB 800 Hz to 5 kHz (150 Ohms) |
| Display: | 40 character vacuum fluorescent plus 4 LED's for ON/OFF-hook status |
| AC Power Supply: | 115 VAC 10%, 60 Hz |
| Operating Temperature: | 0° C to 50° C |
| Storage Temperature: | - 40° C to 70° C |
| Dimensions: | 5.79" H. x 14.33" W. x 14.25" D |
| Weight: | 16 to 18 lbs. depending upon options |

OPTIONS**MF/DTMF/DP RECEIVER AND ANALYZER (OPTION 930A-01)****MF AND DTMF**

| | |
|--------------------------|---|
| Input Level Range: | -25 dBm to 0 dBm |
| Accuracy: | 0.2 dB |
| Resolution: | 0.1 dB |
| Input Frequency Range: | 10% of AT&T standard frequencies for MF and DTMF tones |
| Accuracy: | 0.1% |
| Resolution: | 1 Hz |
| Input Tone ON/OFF Range: | 35 msec. to 250 msec. Tone ON 35 msec. to 250 msec. Tone OFF |
| Accuracy: | 5 msec. |
| Resolution: | 1 msec. |

TABLE 1-1 Specifications (con't)**DIAL PULSE (DP) RECEIVER AND ANALYZER (OPTION 930A-01)**

| | |
|--------------------------|---------------------------------|
| PPS Range: | 5 PPS to 30 PPS |
| Accuracy: | 2% @ 10 PPS |
| Resolution: | 0.1 PPS |
| % Break: | 10% to 90% |
| Accuracy: | 2% (25% to 75% break at 10 PPS) |
| Resolution: | 0.1% |
| Interdigit Timing Range: | 50 msec. to 990 msec. |
| Accuracy: | 5 msec. |
| Resolution: | 1 msec. |

SF SUPERVISION (OPTION 930A-02)

| | |
|-----------------------|----------------------------------|
| SF Oscillator: | 2604 Hz 1.0 Hz |
| Send Level: | -36 dBm0 On-hook, -13 dBm0 pulse |
| Receiver Sensitivity: | -42 dBm0 |

PEAK TO AVERAGE RATIO (P/AR) (OPTION 930A-06)

| | |
|-------------------------|---------------------|
| Transmit Level Range: | 0 dBm to -40 dBm |
| Resolution: | 0.1 dB |
| Receive Level Range: | -40 dBm to +12 dBm |
| Resolution: | 0.1 dB |
| P/AR Measurement Range: | 0 to 120 P/AR units |
| Resolution: | 1 P/AR unit |
| Accuracy: | 1 P/AR unit |

3-LEVEL IMPULSE NOISE (OPTION 930A-07)

| | |
|---------------------|----------------------------------|
| Weighting Filter: | C-Notch,C-Msg,15K,PROG,50KB |
| Threshold Range: | 30 dBmC to 106 dBmC |
| Accuracy: | 1.0 dB |
| Threshold Spread: | 2, 4, 6, or 8 dB steps |
| Timer: | 1 min. to 99 mins. or continuous |
| Counter Capacity: | 0 to 9999 for LO, MD and HI. |
| Measurements Range: | 7 to 99 measurements per second |

TABLE 1-1 *Specifications (con't)***DS-1 PCM DROP/INSERT OPTIONS (OPTIONS 930A-08E AND -09E)**

| | |
|-----------------------------|---|
| Format: | DS-1 AMI or B8ZS Line Code |
| DS-1 Input Frequency: | 1.544 Mbps 15 kbps |
| Jitter Tolerance: | Exceeds Bell Pub 43802 Requirements |
| Channel Numbering Sequence: | D1D, D2, D3/D4/D5 |
| Signaling Mode: | NORM (Robbed Bit) or CCIS |
| Framing Format: | D4 Superframe, Extended Superframe or SLC-96 |
| Selection: | Automatic or manual selection of frame format-D4/SF or ESF |
| Input Mode: | Terminated: 100 Ohms nominal Bridging: >1000 Ohms |
| Input Level: | 200 mV to 6.0 V. base-to-peak |
| Input Level Measurement: | 200 mV to 6.0 V. 50 mV base-to-peak or -23 dBdsx to +3 dBdsx 1 dB |
| DS-1 Output: | 1.544 Mbps 40 bps (Stratum 4) in INTERNAL Clock mode. Output rate equal to input rate in LOOP-TIMED mode |
| Frequency Skew: | Output frequency can be shifted by 100 bps in INTERNAL Clock mode to verify far-end loop-timed status |
| Output Pulse Level: | 3.0 V. nominal base-to-peak into 100 Ohms resistive load |
| Output Imbalance: | Positive and Negative pulses are within 0.2 V. base-to-peak |
| Channel Selection: | Any one of 24 selectable from keypad |
| PCM Supervision Displays: | 40 character vacuum fluorescent display shows A and B bit signaling states for all 24 channels (Menu Option #20) simul- taneously. In ESF mode A, B, C and D bits are displayed. 4 LED's show status of ON/OFF-hook supervision of selected time slot |

TABLE 1-1 Specifications (con't)

| | |
|----------------------|--|
| Operating Modes: | TERMINATE: selected channel is connected to channel generator and receiver. Other 23 channels send IDLE code (7F) MONITOR: monitor selected channel in one or both directions. All 24 channels pass through unchanged. Framing is regenerated. DROP&INSERT: dual-direction only. Selected channel dropped out for testing. Other 23 channels pass through unchanged. (Option 930A-09E) |
| Pattern Simulation: | Idle Code (7F), Received PCM Optional patterns require Option 930A-22 Bit Error Rate testing |
| Frame Loss Criteria: | Loss of frame occurs when 2 out of 4 F_t bits are in error for Superframe and SLC-96. Loss of frame for ESF occurs when 2 out of 4 FPS bits are in error |
| Error Displays: | Detects and counts Frame Errors, Bipolar Violations, Frame Slips and CRC Errors (ESF Only). |
| Alarms: | Sends Blue Alarm (All Ones) or Yellow Alarm (ALL Bit#2=0) on Superframe and sent on Facility data Link for ESF |
| Alarm Displays: | Detects and displays Frame Loss, Carrier Loss, Excess 0's, Yellow and Blue Alarm. |

PCM CHANNEL ENCODER

| Analog Tone Generation: | 20 Hz to 3904 Hz selectable in 1.0 Hz steps from keypad | | | | | | | | |
|-------------------------|--|-----------------|--------------|--------|-----------------------|--------|----------------------|--------|----------------------|
| Tone Level: | +3.0 dBm to -50.0 dBm in 0.1 dB steps selectable from keypad | | | | | | | | |
| Frequency Response: | 0.1 dB (20 Hz to 3904 Hz) | | | | | | | | |
| Basic Accuracy: | <table> <thead> <tr> <th><u>Accuracy</u></th> <th><u>Level</u></th> </tr> </thead> <tbody> <tr> <td>0.1 dB</td> <td>+3.0 dBm0 to -30 dBm0</td> </tr> <tr> <td>0.2 dB</td> <td>-30 dBm0 to -40 dBm0</td> </tr> <tr> <td>0.5 dB</td> <td>-40 dBm0 to -50 dBm0</td> </tr> </tbody> </table> | <u>Accuracy</u> | <u>Level</u> | 0.1 dB | +3.0 dBm0 to -30 dBm0 | 0.2 dB | -30 dBm0 to -40 dBm0 | 0.5 dB | -40 dBm0 to -50 dBm0 |
| <u>Accuracy</u> | <u>Level</u> | | | | | | | | |
| 0.1 dB | +3.0 dBm0 to -30 dBm0 | | | | | | | | |
| 0.2 dB | -30 dBm0 to -40 dBm0 | | | | | | | | |
| 0.5 dB | -40 dBm0 to -50 dBm0 | | | | | | | | |

TABLE 1-1 Specifications (con't)

Supervision: NORMAL (E&M), USER DEFINED states of A and B bits (C and D bits in ESF). FXO/FXS simulation (Option 930A-25)

Signaling: MF, DTMF and DP

PCM CHANNEL DECODER

Recovered Analog Tones: 20 Hz to 3904 Hz 1 Hz
 Recovered Level: +3.0 dBm to -40.0 dBm (Average and RMS)

Basic Accuracy: 0.1 dB with Digital Milliwatt

| Accuracy | Input Level |
|----------|-----------------------|
| 0.1 dB | +3.0 dBm0 to -30 dBm0 |
| 0.2 dB | -30 dBm0 to -40 dBm0 |
| 0.5 dB | -40 dBm0 to -50 dBm0 |

Frequency Response: 0.1 dB @ 204 Hz to 3904 Hz with 0 dBm applied.

Supervision: On-hook and Off-hook supervision are user definable as any combination of A, C and B, D bits (i.e., 0, 1, or "don't care"). FXO/FXS supervision available with Option 930A-25

Signal to Total Distortion:

| Input | 7 5/6 Sgnlng | CCIS |
|-----------------|--------------|-------|
| 0 to -30 dBm0 | 38 dB | 40 dB |
| -30 to -40 dBm0 | 36 dB | 36 dB |
| -40 to -50 dBm0 | 32 dB | 32 dB |

Gain Tracking Error:

| Input | Max. Deviation |
|------------------|----------------|
| +3.0 to -30 dBm0 | 0.1 dB |
| -30 to -40 dBm0 | 0.2 dB |
| -40 to -50 dBm0 | 0.5 dB |

Intrinsic Noise: 10 dBmC (with Idle Code received)

TABLE 1-1 Specifications (con't)**PHASE/AMPLITUDE JITTER AND HITS (OPTION 930A-18)**

Phase and Amplitude Jitter Measurement

| | |
|-------------------------------|---|
| Received Holding Tone Level: | +10 dBm to -40 dBm (Metallic) 0.0 dBm to -40 dBm (PCM) |
| Holding Tone Frequency Range: | 990 Hz to 1030 Hz |
| Phase Jitter Measurement: | 0.0° to 30.0° peak-to-peak |
| Accuracy: | 5%, 0.2° |
| Amplitude Jitter Measurement: | 0.0% to 30.0% peak |
| Accuracy: | 5%, 0.2% |
| Weighting Filter Bandpass: | 4 Hz to 300 Hz, and 20 Hz to 300 Hz |

Transients (Hits) Measurements *

| | |
|-------------------|--------------------------------------|
| Phase Hits: | 5° to 50° peak in 1° steps |
| Gain Hits: | 1 to 10 dB in 1 dB steps |
| Dropouts: | Tone level drops below 12 dB 1 dB |
| Guard Interval: | Per IEEE STD. 743-1984 Figs. 6 and 7 |
| Timer: | Same as Impulse Noise |
| Count Rate: | Same as Impulse Noise |
| Counter Capacity: | Same as Impulse Noise |

* Option 930A-18 requires that Option 930A-07 (Impulse Noise) be installed as well. The Impulse Noise counts are interlocked with the transient measurements in accordance with IEEE specifications.

ENVELOPE DELAY DISTORTION MEASUREMENT (OPTION 930A-19)

| | |
|----------------|--|
| Modes: | SEND and REPEAT (Master and Slave) |
| Transmitter: | 50% AM signal at modulation frequency of 83 $\frac{1}{3}$ Hz Carrier Frequency: 304 Hz to 3504 Hz 2 Hz |
| Carrier Level: | 0.0 dBm to -40 dBm (Metallic) 0.0 dBm to -40 dBm (PCM) |
| Flatness: | 0.2 dB (304 to 3504 Hz) |

TABLE 1-1 Specifications (con't)

| | |
|-------------------------------|---|
| Receiver Input Level: | +10 dBm to -40 dBm (Metallic) 0.0 dBm to -40 dBm (PCM) |
| Distortion Measurement Range: | +9000, -3000 seconds |
| Accuracy: | 10 s 604 Hz to 3504 Hz 30 s 304 Hz to 603 Hz |

INTERMODULATION DISTORTION (OPTION 930A-20) *

| | |
|--------------------------|--|
| Transmitter Spectrum: | Four equal level tones (857, 863, 1372 and 1388 Hz) |
| Harmonic Distortion: | >35 dB below tone level |
| Transmitter Level Range: | 0 dBm to -40 dBm RMS (Metallic) -6 dBm to -40 dBm RMS (PCM) |
| Accuracy: | 1 dB |
| Receiver Input Level: | 0 dBm to -40 dBm RMS (Metallic) -6 dBm to -40 dBm RMS (PCM) |
| Distortion Products: | 2nd Order centered at 520 and 2240 Hz 3rd Order centered at 1900 Hz |
| Distortion Range: | 10 dB to 70 dB below signal-2nd Order 10 dB to 70 dB below signal-3rd Order |
| Resolution: | 1 dB |
| Accuracy: | 1 dB |
| Signal-to-Noise Test: | Removes Low Tone pair and increases level of remaining tone pair by 3 dB. |

*

Licensed under Hekimian Laboratories, Inc. Patent No. 3, 862, 380

TABLE 1-1 *Specifications (con't)***DS-0/DS-1 BIT ERROR RATE TESTING (OPTION 930A-22)****DS-1 BERT SPECIFICATIONS**

| | |
|------------------------|--|
| Input: | See Option 930A-08E/09E specifications |
| Output: | See Option 930A-08E/09E specifications |
| Framing: | Patterns may be framed (D4 or ESF) or unframed |
| Test Patterns: | Pseudo-random bit sequences (PRBS) of the following lengths may be sent and received: 2^9-1 (511) $2^{11}-1$ (2047) $2^{15}-1$ $2^{20}-1$ QRSS ($2^{20}-1$ with 14 zero suppression) $2^{23}-1$ |
| Stress Patterns: | 3 in 24 bits (100010001000000000000000) 1 : 7 bits (10000000) 1 : 1 bits (1010) All 1's 55 OCTETS (440 bit pattern for Multiplexer Testing) |
| User-Defined Patterns: | User may input any bit sequence length from 1 to 24 bits (even numbers from 18 to 24). Pattern will continuously repeat |
| Loop-back Codes: | Send and Receive CSU loop codes: Loop-Up= 10000 continuous for 8 seconds Loop-Down= 100 continuous Other Loop codes can be sent and received by editing the above patterns |
| Error Injection: | Inject single logic errors, bipolar violations, frame errors (D4 mode) or CRC errors (ESF mode) |

TABLE 1-1 *Specifications (con't)***DS-1 BERT SPECIFICATIONS (Continued)**

| | |
|---------------------|---|
| PRBS Receiver Sync: | 128 consecutive error-free bits must be received to achieve synchronization. BER of greater than 10^{-1} for 320 milliseconds causes sync loss and resync attempt |
| Pattern Sync: | 386 consecutive bits with less than 10^{-2} error rate must be received to achieve pattern sync. BER of greater than 10^{-2} for 2 milliseconds causes sync loss and resync attempt |
| Measurements: | Measures and displays: Bit (Logic) Errors, Bit Error Rate, Bit Slips, Bipolar Violations (BPV), Frame Errors, Frame Losses, Frame Slips, CRC Errors (ESF mode), Errored Seconds, % Errored Seconds, Error Free Seconds, % Error Free Seconds, Severely Errored Seconds, % Severely Errored Seconds, Failed Seconds, % Failed Seconds, Unavailable Seconds, % Unavailable Seconds, % Availability, No PCM, Test Length, Clock Time/Date, Elapsed Time |
| Test Length: | Timed or continuous |
| Timed Test Length: | 15 minutes, 1 hour or 24 Hours |

DS-0 BERT SPECIFICATIONS

| | |
|----------------|---|
| 56 kbps Mode: | Selected when 930A is in Option 56. Least significant bit of channel under test is always set to 1. |
| 64 kbps Mode: | Selected when 930A is in Option 56 Requires change to CCIS Signalling |
| Test Patterns: | Pseudo-random bit sequences (PRBS) of the following lengths may be sent and received: 2^9-1 (511) $2^{11}-1$ (2047) |

Stress Patterns: 1 : 7 bits (10000000)
 1 : 1 bits (1010)
 All 1's
 USER

User-Defined Patterns: User may input any bit sequence length
 from 1 to 8 bits
 Pattern will continuously repeat

Loop-Back Codes: Send and Receive CSU/DSU/OCU loop codes
 in 56 kbps mode. LSB of selected channel
 byte is always set to 0. Cannot be used with
 switched 56 kbps channels using robbed bit
 signaling.

Error Counters: All DS-1 errors (i.e., BPV errors, frame errors,
 CRC errors, Slips, etc.) are recorded for the
 entire DS-1
 Bit Errors and Bit Error Rate are calculated on
 the received DS-0 channel selected. CCITT
 G.821 Error statistics are based on the bit errors
 of the selected DS-0 channel received

Measurements: Bit Errors, Bit Error Rate, No Sync, Error Free
 Seconds, % Error Free Seconds, Errored
 Seconds, % Errored Seconds, Severely Errored
 Seconds, % Severely Errored Seconds, Failed
 Seconds, % Failed Seconds, Available Seconds,
 % Available Seconds, Unavailable Seconds, %
 Unavailable Seconds and Elapsed Test Time

Error Injection: Inject single bit errors

APS TEST SPECIFICATIONS (MENU OPTION 47)

Error Injection: Injects controlled rate of BPV errors for specific
 time to test Automatic Protection Switches or
 enables user to send a fixed rate of BPVs

APS Test: Injects 0.9×10^{-3} BPVs for 20 seconds then
 1.1×10^{-3} BPVs for 20 seconds and finally
 0.9×10^{-4} BPVs for 20 seconds

Fixed Error Rates: 0.9×10^{-3} , 1.0×10^{-3} , or 1.1×10^{-3} BPVs

SECTION II INSTALLATION

2-1 INTRODUCTION

This section provides information regarding initial inspection and damage claims, preparation for operation, power requirements, storage and shipment. Also provided is a physical description of the Model 930A.

2-2 INITIAL INSPECTION

When the instrument arrives, inspect the shipping container for visible signs of stress or damage. If the shipping container, or packaging material, is damaged, **notify the carrier**, as well as **SAGE**, immediately. Retain the materials until the contents have been checked mechanically and electrically. The contents of the shipment should be: One Model 930A, one copy of the Operating Manual, and one AC power cord. Accessories may, or may not, be shipped in the same container as the Model 930A, depending upon their size. Check the shipping invoice carefully against the contents received.

2-3 PREPARATION FOR USE

CAUTION

This instrument is designed to operate on 115 VAC, 60 Hz power. Connection to a power source other than this will cause damage to the Model 930A. Consult the factory for optional power sources.

Connect the Model 930A to any standard 3-conductor outlet of 115 VAC, 60 Hz using the power cord supplied with the unit. The 3-wire power cord supplied with the unit grounds the instrument.

WARNING

Do not interrupt the protective (ground) conductor (inside or outside the instrument), or disconnect the protective earth terminal, as this can make the instrument an electrical shock hazard.



**SAGE INSTRUMENTS MODEL 930A
FIGURE 2-1**

2-4 OPERATING ENVIRONMENT

This instrument may be operated in temperatures from 0 C to 50 C (+ 32 F to + 122 F). The instrument will operate in environments with humidity from 10 to 90% relative humidity, non-condensing, at +40 C (104 F).

2-5 STORAGE AND SHIPMENT

The instrument may be stored and shipped within the following environmental limits:

- * Temperature -40 to +70 C
- * Humidity Up to 90% Relative @ +65 C

If possible, retain the original shipping container and packing materials. If you should ever have to return your 930A to SAGE, the original packaging will protect the instrument. In the event that the original container is no longer available, the following general instructions should be used for repackaging the instrument with commercially available materials.

1. Include return address, serial number, returned material authorization number, and the name of a technical contact when returning instrument for service.
2. Use a double-walled carton of at least 350 pound test material. Dimensions must be 21"L.x19.5"W.x14.25"H. to provide space for shock-absorbing material.
3. Use a 3-4 inch layer of shock absorbing foam material (**do not use "popcorn" foam**) on all sides, top, and bottom of the instrument. Protect the front panel with cardboard.
4. Seal the container securely.
5. Mark the container **FRAGILE** to ensure careful handling. Write the **RMA** number on the box (Not in the address location).
6. Refer to the instrument model number and serial number in any correspondence.

The instrument warranty will be voided if an instrument is returned and found to be improperly packaged.

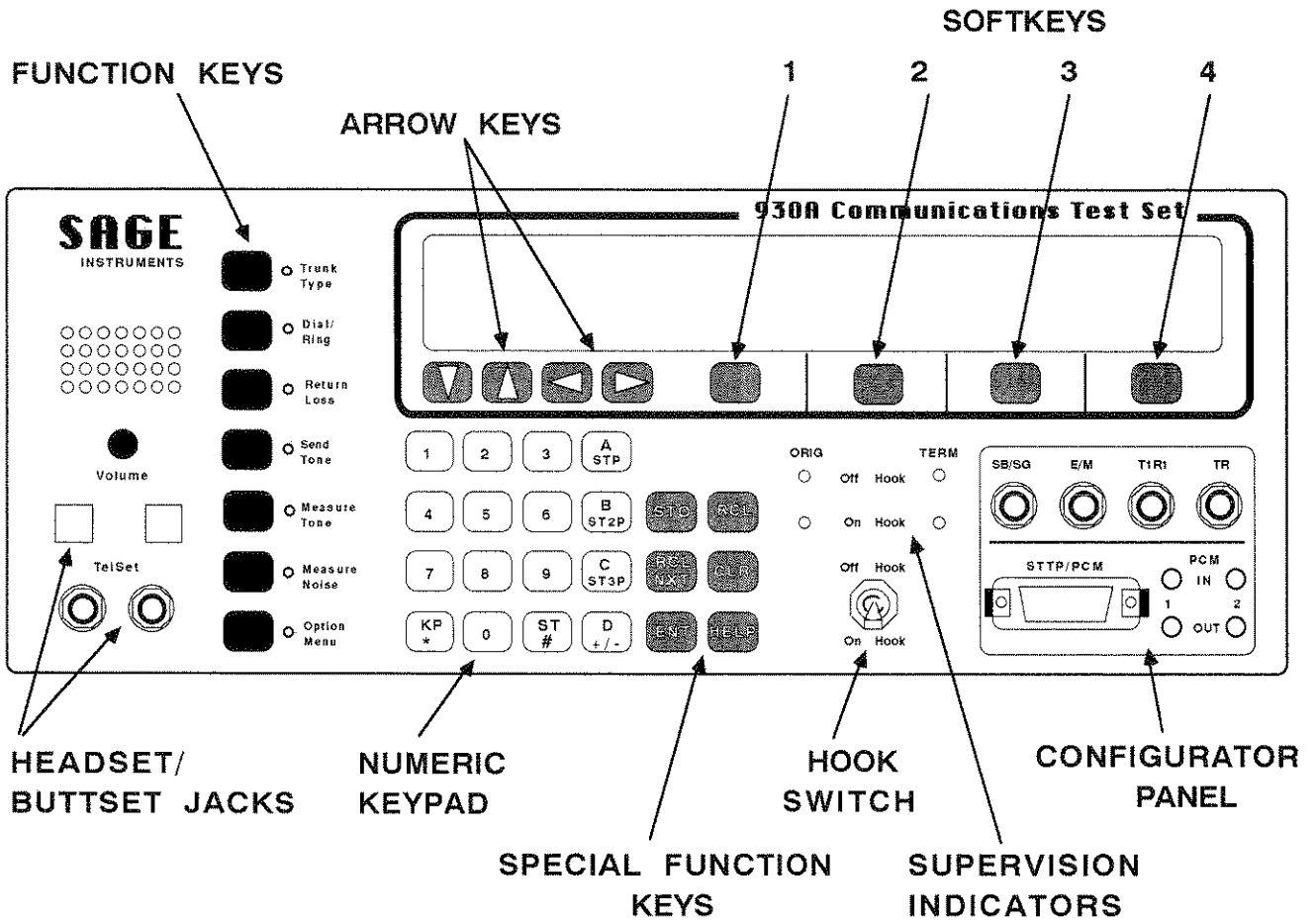

MODEL 930A FRONT PANEL
FIGURE 2-2

2-6 PHYSICAL DESCRIPTION

The SAGE Instruments Model 930A shown in Figure 2-1 measures 5.79" H. x 14.33" W. x 14.25" D. A convenient carrying handle extends 1.25" from the right side of the instrument case. Two smaller carrying handles extend 1.25" from the front panel of the Model 930A. Four rubber feet extend 0.5" from the left side of the case. Four large plastic feet extend 1" from the rear panel of the unit permitting the operator to set the unit on end when performing tests at the DSX jackfield. The unit normally sits on the four plastic feet which extend 0.5" from the bottom of the case. For ease of viewing, the Model 930A is equipped with a pivot brace inside the front feet. This raises the front of the unit three inches when extended.

The front panel shown in Figure 2-2 measures 5.25" H. x 13.5" W. It contains 37 keys, 11 LED's, a speaker grill, a volume control knob, two carrying handles, a hook-switch, a 2.25" x 3.25" configurator panel which contains the input/output connectors, a 40 character alphanumeric Fluorescent Indicator Panel, and connectors for a headset and Telephone Handset.

The configurator panel is located in the lower right side of the front panel as shown in Figure 2-2. Depending upon which configurator has been ordered, it will contain some combination of 310 jacks, bantam jacks, 5-way binding posts, or a 15 pin subminiature D-type connector. Various configurators are shown in Figure 2-3.

The "A" configurator is used in units intended for entirely analog operation and having no T1 PCM options. The Type 310 jacks are for the analog input/output and are labeled **SB/SG** (Signal Battery/Signal Ground), **E/M** (The E- and M-leads), **T/R** (Tip and Ring), and **T1/R1** (Tip1 and Ring1). The **E/M** and **SB/SG** leads are used for **E&M** signaling. **TR** and **T1R1** are used by all 4-wire analog trunks. All 2-wire signaling and transmission is done over **TR**. The binding posts, below their corresponding 310 jacks, are labeled **SG, SB, E, M, T, R, T1, and R1**.

The "A/P" configurator is intended for use in those units which have both analog and digital (**T1 PCM**) capability. That is, Option 930A-08E or -09E has been installed. The bantam, or tiny telephone, jacks provide digital access for the **PCM** trunks. They are labeled **PCM1 IN, PCM1 OUT, PCM2 IN, and PCM2 OUT**. The "**310 A/P**" is the same except all jacks are Type 310.

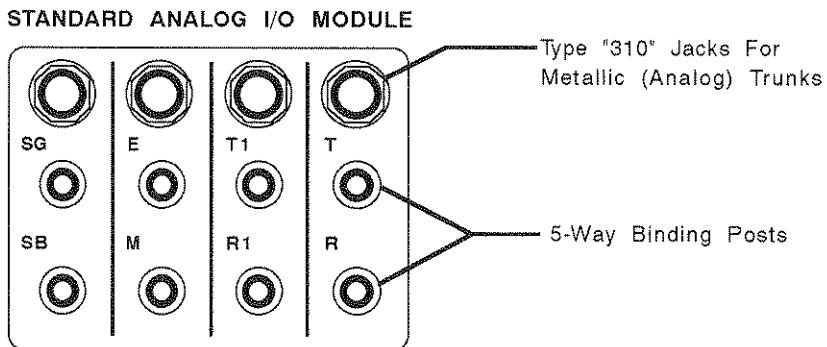
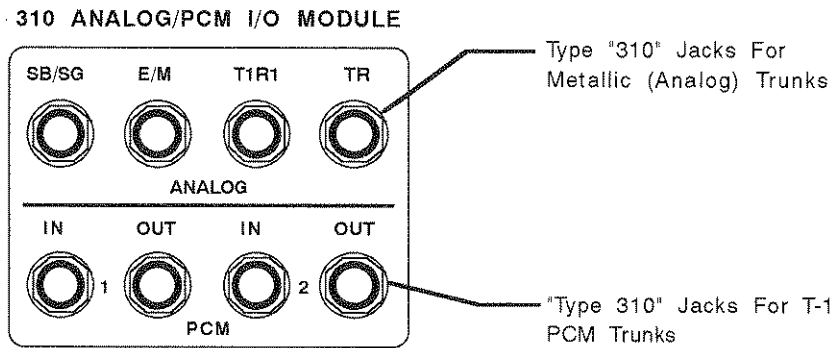
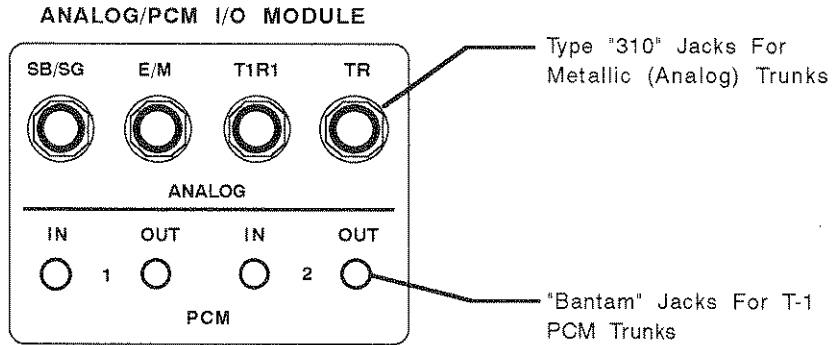
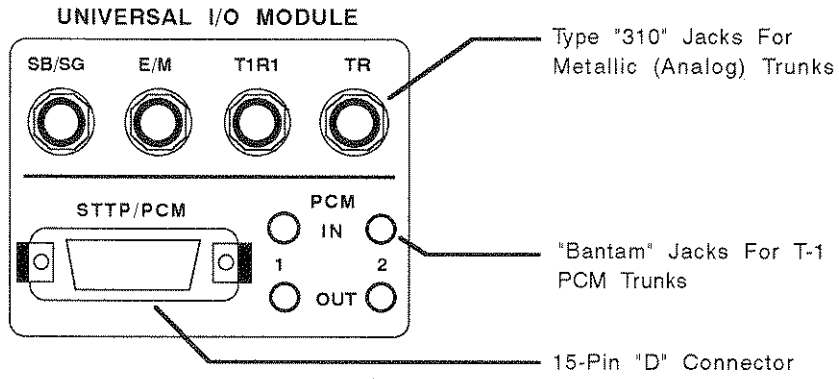

CONFIGURATOR PANELS[®]
FIGURE 2-3

The "UNIV" configurator is intended for use with analog/digital trunks and also has a 15 pin subminiature D-type connector for use with the SAGE Model 114A Supplementary Trunk Test Panel Adapter. This would mean that Option 930A-14 has been installed.

The rear panel shown in Figure 2-4 measures 5" x 13.5" and contains the following:

- ON/OFF Switch
- Recessed connector for 3-prong power cord
- Fuse Holder
- Fan Grill
- Grounding Lug
- 25 pin RS-232C D-type connector (optional)
- Four plastic feet with soft rubber tips

The **ON/OFF** switch controls power to the 930A. It is located at the top center of the rear panel as shown in Figure 2-4. The AC power connection is located directly beneath the **ON/OFF** switch and is intended for use only with the power cord supplied with the unit.

The fuse holder is spring loaded. To gain access to the fuse, insert a flat blade screwdriver into the fuse holder slot and make a 1/4 turn counter-clockwise. The fuse is a 2 Amp Slow-Blow. If a power surge causes the fuse to fail, be sure to replace it **ONLY** with a fuse of the same rating, and **ONLY** after determining that the condition which caused the failure no longer exists.

The fan grill allows access for cooling air into the Model 930A. **Do not** block the air intake, place it adjacent to a heating duct, or operate the unit standing on it's rear panel on a thick carpet. Holes drilled in the upper right side of the rear panel are intended for the exit of warm air. These should not be blocked; damage to the Model 930A will result.

The rear panel plastic feet support the 930A on a level surface for operator convenience. **DO NOT** place an operating 930A on thick carpets, or on surfaces that are thick with dust, as access to the fan grill may be blocked.

The grounding lug, located at the lower left edge of the rear panel, provides ready access to the Model 930A's case ground for safety purposes.

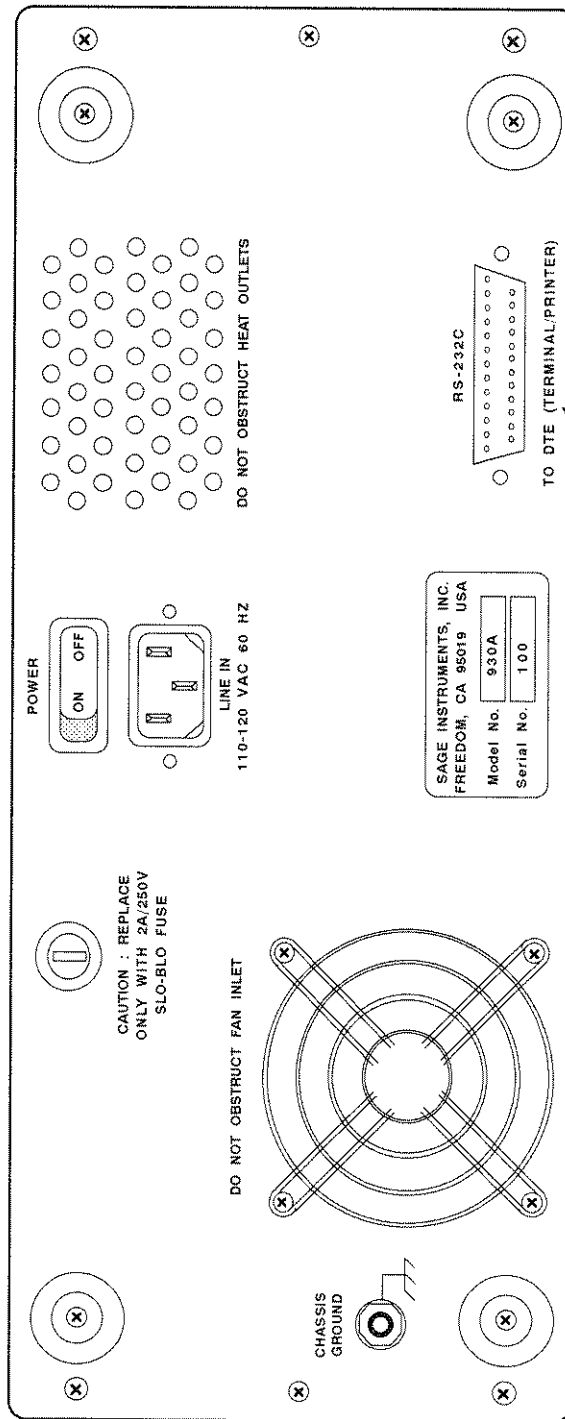

RS-232C
REMOTE CONTROL/
PRINTER PORT

MODEL 930A REAR PANEL
FIGURE 2-4

The RS-232C connector (Option 930A-10C), when present, is located at the lower right side of the rear panel. The connector is configured internally as Data Communication Equipment (DCE). This enables direct connection to Data Terminal Equipment (DTE) such as terminals or printers. However, connection to a MODEM (DCE) must be made through a "null modem" adapter cable.

CAUTION

The rear panel is held in place by four screws.

DO NOT REMOVE THEM

Access to the interior of the Model 930A is provided by removing the top cover.

The top cover of the 930A case is secured by four, 3/8 inch Phillips-head screws. Removing these screws allows the cover to be lifted off, giving access to the interior. Figure 2-5 shows the interior of the Model 930A.

At the rear of the interior is a gold anodized box which contains the power supply.

WARNING

DO NOT ATTEMPT TO OPEN OR REMOVE THIS BOX

Doing so will expose the user to dangerous voltages.

The power supply is a 115 VAC line switching supply. It is intended for connection to standard U.S. line outlets and provides -48 V, 15 V., and +5 V. internally. If you should need 230 VAC, 50 Hz operation, call SAGE for instructions on converting the power supply.

There are seven PC Card slots inside the case. Some or all of these will be filled with cards depending upon options installed. The common cards for all units include: A CPU card, a Digital Signal Processing (DSP) card, an AC interface, and a DC interface card (Standard Analog access configuration). Other card slots are for options such as one or two PCM cards.

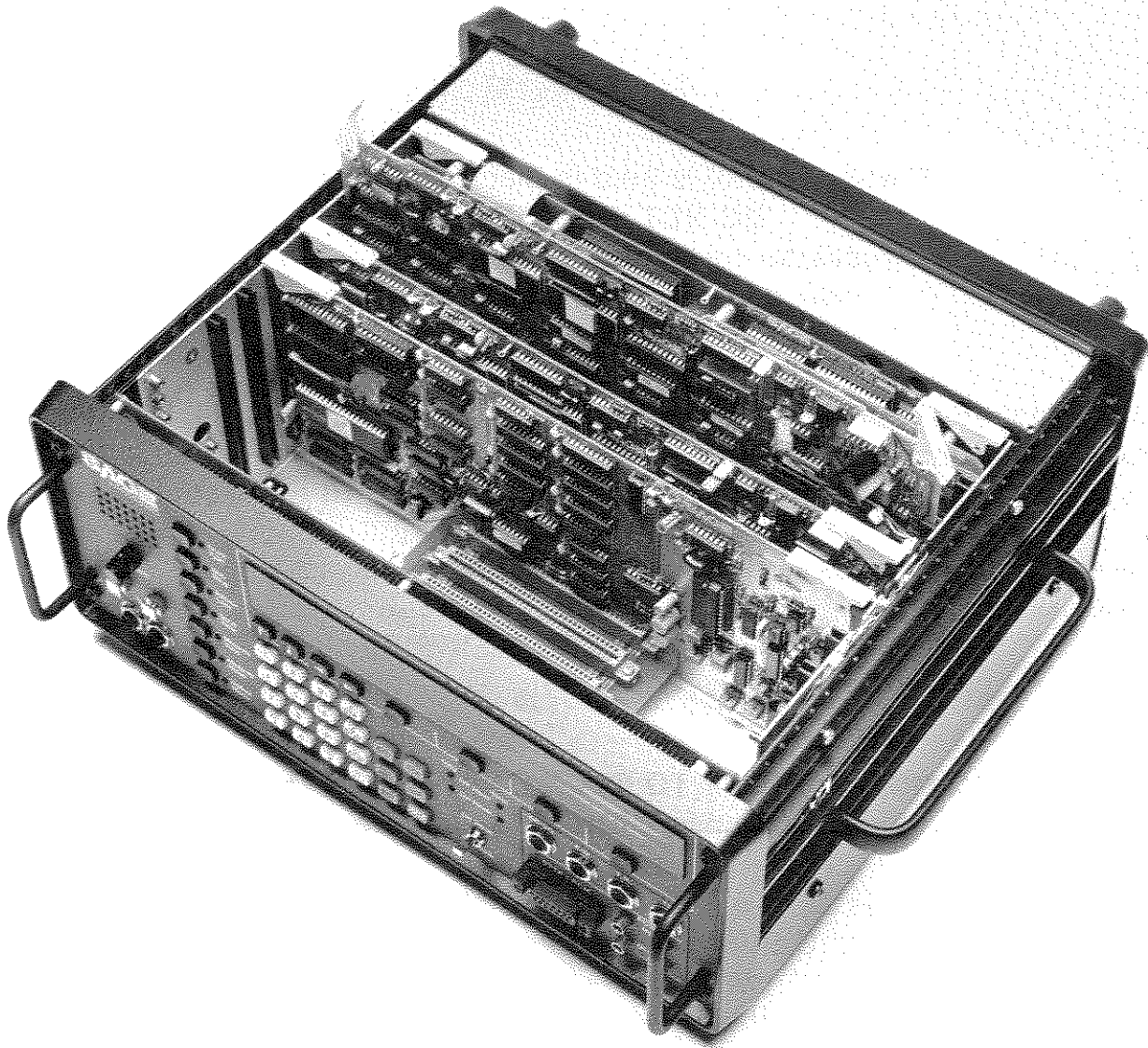

**MODEL 930A INTERIOR VIEW
FIGURE 2-5**

You may have occasion to remove a card from the Model 930A. Remove any attached cables from a card before attempting to remove the card.

WARNING

DO NOT REMOVE OR INSERT CARDS WHILE POWER IS ON

Cards are removed by means of the extractors built into each card. The small white plastic handles in each corner of the cards are the extractors. To remove a card, grasp the extractor handles and pull straight upward in an even motion.

When reinserting cards, they should enter their slots with an audible and tactile snap. Be sure that the cards are returned to the slot they came from and that all connecting cables to the cards have been correctly restored before applying power. Partially inserted boards will be damaged if power is applied.

The card edge contacts and the edge connector itself should be free from dirt, oxidation, or residues of any kind. If they are not, gentle cleaning with a special contact cleaning solution and a lint-free cloth may be necessary. Spray-on contact cleaners are available at most electronics stores.

This page intentionally left blank.



SECTION III BASIC ANALOG OPERATION

3-1 INTRODUCTION

This section of the manual provides you with information on the **operation** of the Model 930A's **standard features**. The Model 930A is a general purpose test set which has been designed to test Equal Access (Feature Group D), T-1, PBX, Data, Toll, Message, and Private Line trunks. The Model 930A is particularly well-suited to testing at the **DEMARC**, or Point of Interface (**POI**).

3-2 GETTING THE 930A TO DO WHAT YOU REQUIRE

To begin:

The operation proceeds as follows:

1. Turn unit on.
2. Select Trunk Type, set direction (Office or Customer), set interface (2W 900 Ohm, 4W 600 Ohm, etc.), and select Terminated or Bridged operation, using softkeys.
3. Select desired test function such as Dial/Ring, Send Tone, Measure Noise, or optional function.
4. Use **HELP** and/or softkeys to set-up test functions if required.
5. Use front panel Hookswitch to seize the trunk, draw dial tone and hold the circuit up during test.
6. Use Numeric Keypad as required to dial out, etc.

You will find that the 930A retains the last settings you input so that it is only necessary to set up functions once in most cases.

Familiarize yourself with the locations of the front panel keys and press them to see what they do in various screens. In particular, see what the arrow keys and softkeys do. It is a good idea not to connect the 930A to the actual trunk under test until after you are familiar with its operation. Start with a Metallic connection in Analog Mode.

If you have the T-Carrier interface option installed in your 930A, you will find its operation covered in Section IV of this manual. Be aware that the 930A will sound a PCM audible alarm when in PCM mode and the T1 facility is not connected. Connect the T1 via a Bantam cord connection or use Option 15 to turn off the audible alarm.

Remember, the definition of a softkey changes with the display above it. Pressing a softkey will do one of the following things:

1. Nothing-The softkey you pressed is not active
2. Change to another displayed value (i.e., from **TERM** to **BRIDGE**)
3. Move the cursor or highlight over a parameter to be changed (i.e., pressing softkey under the level in the **SEND TONE** menu moves the flashing cursor from frequency to level so it can be changed).
4. Cause other parts of the display to change as well (i.e., changing from 2-wire to 4-wire mode on an analog trunk causes the 930A to go from Terminated to Bridged operation if it is not already there).

Data entry on the Model 930A is accomplished in one of three ways: Numeric entry using the Numeric Keypad; Menu entry using the Softkeys; or incremental entry using the Cursor or Arrow Keys.

3-2.1 TURNING ON THE 930A

When first powered up, the 930A will run through a PROM check and then briefly display the following:

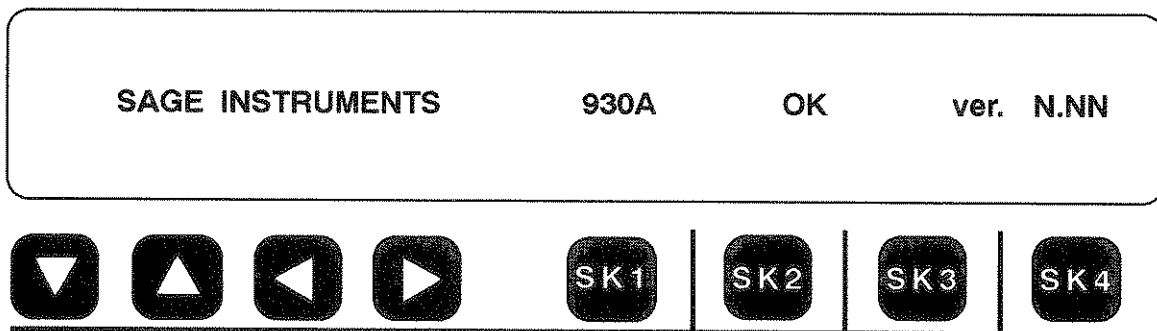

“N.NN” is the version of software present in the unit. Note the condition of the eleven LED's on the front panel. If a normal **“Warm-Boot”** has occurred, one LED will be lit or flashing. If an error has been detected by the built-in self test, all of the LED's will be lit and the unit will perform a **“Cold-Boot.”** This is an abnormal condition indicating a possible malfunction of the test set. Turn the 930A off and perform a **“Cold-Boot”** as described in Paragraph 3-2.2.

3-2.2 HOW TO "COLD-BOOT" THE 930A

There are two types of "cold-boots" you can perform on the 930A. One is a complete "hardware cold-boot" and the other is a "software cold-boot." The latter has been added for the convenience of persons writing remote control software and can be found in Option Menu 92.

1. Turn off the 930A
2. Hold down the **TRUNK TYPE** (or any other) function key.
3. Keep the function key held down, turn on the 930A but do not release the function key until the display has scrolled all the way across the screen, and the 930A has started its PROM check.

A successful cold-boot will erase any previously stored settings, or test results, and restore factory defaults to all menus. The 930A will, after it completes its PROM test, come up in its default Trunk Type display which is shown below:

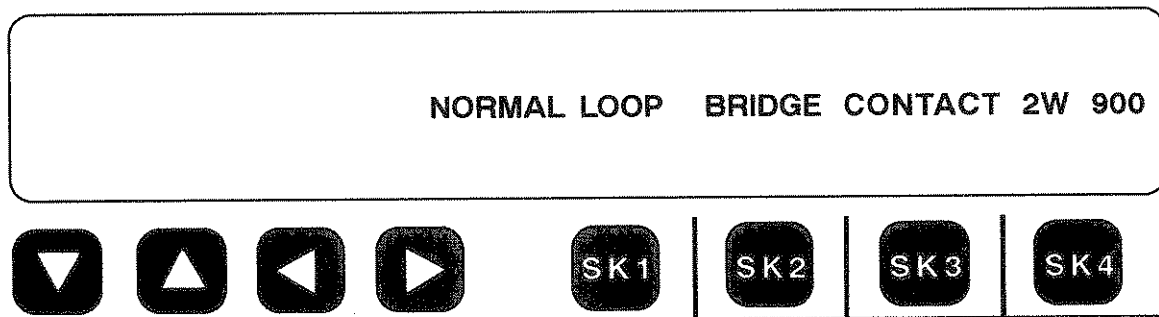

NOTE:

If you have purchased your 930A without an analog interface (T1 only), then your default Trunk Type is PCM.

If the 930A does not come up to the default Trunk Type, then you did not get a cold-boot. Should you encounter any difficulty, please do not hesitate to call SAGE Customer Service at (408) 761-1000.

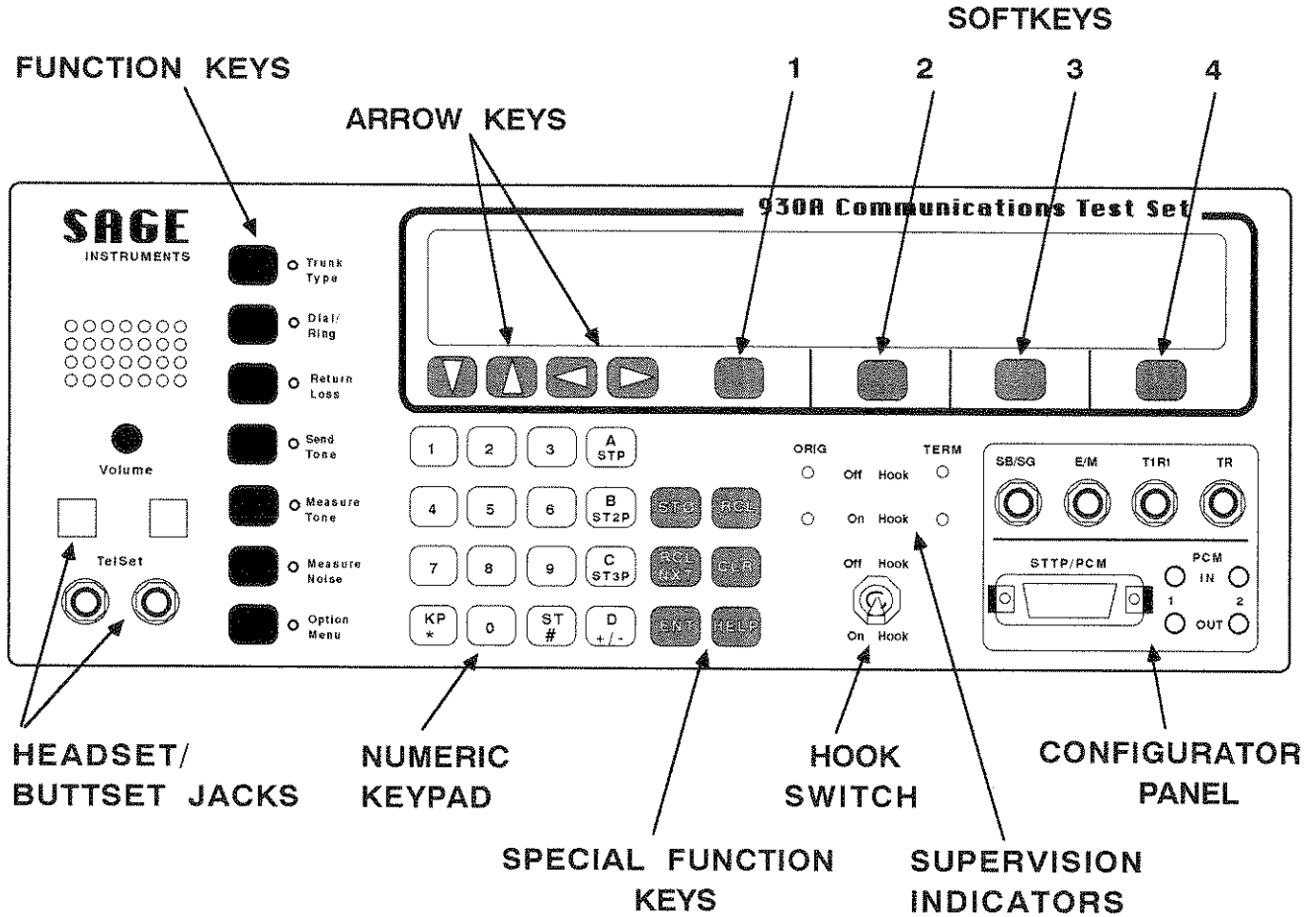

**FRONT PANEL LAYOUT
FIGURE 3-1**

3-3 FRONT PANEL CONTROLS, INDICATORS, AND CONNECTORS

The front panel layout with the locations of the controls, indicators, and connectors is shown in Figure 3-1. The descriptions start with the keypad and finish with the function keys because they take the most explanation.

3-3.1 HOW TO USE THE NUMERIC KEYPAD

The Numeric Keypad consists of the sixteen white keys located directly beneath the left hand corner of the display as shown in Figure 3-1 and in the enlarged diagram below. It is exactly the same as a telephone touch pad.

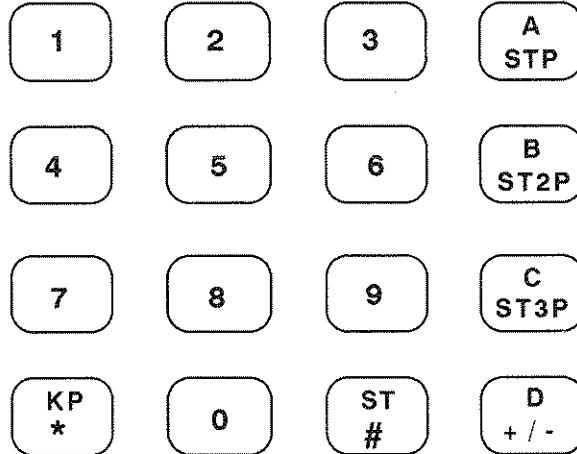

When entering numerical data such as Tone Frequency or Level, you will generally be prompted by a flashing cursor as to the digit location and number of digits expected by the 930A. Once the correct numerical values have been selected, you press either the **ENTER** key (See Section 3-3.2.5) or any of the softkeys. Any leading blanks (digits expected but not entered) are treated as zeros. The sign of a number, such as tone level, may be changed by pressing the +/- key before you press **ENTER**.

AS LONG AS THE CURSOR IS DISPLAYED, NUMERICAL INPUT IS EXPECTED. The 930A will accept numeric data, or the +/- (change sign key), in this mode. Input may be terminated by pressing the **ENT** key, any softkey, or any function key. The following example shows you how to use the Numeric Keypad.

EXAMPLE:

Press the **SEND TONE** function key. The most recent selection used will be displayed. A flashing cursor appears over the last digit of the frequency displayed. To change the frequency value, enter the desired number using the numeric keypad and then press the **ENTER** key. The new value will be displayed. Until the **ENTER** key is pressed, the digits may be changed and overwritten without affecting the tone being sent. The number displayed is only accepted when the **ENTER** key is pressed.

3-3.2 HOW TO USE THE SPECIAL FUNCTION KEYS

The six light gray keys, located to the right of the Numeric Keypad, are the **Special Function** keys. The keys, and a brief description of their functions, follows in subsections 3-3.2.1 to 3-3.2.6.

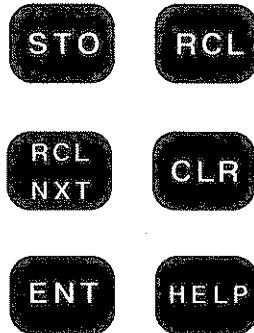

To Store a Test Set-Up, Menu Option, or Function in Memory:

1. Press the key labeled **STO** (Store).
2. Enter the number (01 to 39) of the memory location in which the "program" is to be stored.
3. Press the key labeled **ENT** (Enter) to complete storage exactly as you would do on a calculator.

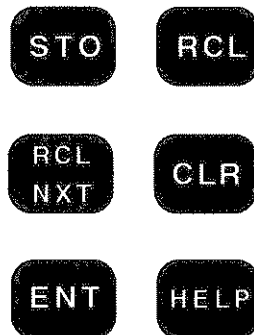

3-3.2.1 HOW TO STORE SETTINGS AND TEST SET-UPS

The **STORE** key is used to store a particular test set-up, outpulse sequence, digit string, or any Option Menu such as **DIGIT RECEIVER**, into one of the forty register locations (01 to 39). This is done by pressing the **STO** key, entering the two-digit number corresponding to the register location desired, and then pressing the **ENTER** key.

The 930A will retain what you have stored in its memory until the lithium battery on it's CPU runs down, or you overwrite that memory location with a new program, or you do a **cold-boot** which erases all memories.

The following display appears after the **STO** key is pressed:

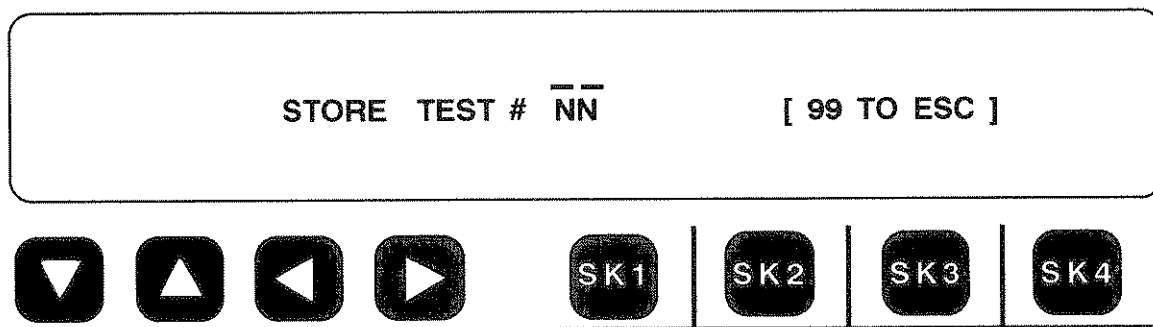

“ **NN** ” in the display is the number of the storage location.

3-3.2.2 DETAILS OF THE STORE FEATURE

It is a good idea to use consecutive storage locations for related test set-ups. The Model 930A automatically increments the storage location after each entry. Press **STO** and **ENT** to store in consecutive memories.

Storing something new in a memory location automatically replaces the previous contents. A general description of the stored parameters for various test situations follows:

In Trunk Type: All of the trunk type parameters listed on the display are saved exactly as they are shown. For **PCM** trunks this includes the undisplayed parameters set in the submenu.

In Dial/Ring: The displayed digits, the outpulsing mode (**MF**, **DTMF**, or **DP**), **AND ANY MODIFICATIONS** made in **Modify Send Digits** (Option Menu 1) are saved. If a digit string has been stored with modifications, the outpulsing label (**MF**, **DTMF**, or **DP**) will be preceded by the “>” character.

In Return Loss: All of the displayed parameters, including signal type, echo-suppress tone, and transhybrid loss are saved.

In Send Tone: The level, frequency, and Tone On/Tone Off are saved.

In Measure Tone: The relative zero level is saved.

In Measure Noise: The filter type, balanced or noise-to-ground measurement, and relative zero are saved.

NOTE: In any measurement function, it is the test set-up (parameters) which is saved, **NOT THE CURRENT MEASUREMENT RESULTS.**

To store a set-up from within an Option Menu, **EXIT TO THE OPTION MENU** by pressing the **OPTION MENU** key. All parameters of the menu selection (whose name and number are displayed) can then be saved using the **STO** key. The only exception to this is **Modify Dial/Ring** (Option Menu 1). Parameters set in **Modify Dial/Ring** are considered to be undisplayed parameters of the Dial/Ring Function and are saved with Dial/Ring.

To recall a Test Set-Up, or Function, from Memory:

1. Press the key labeled **RCL** (Recall).
2. Enter the two-digit number of the location in memory where the program is stored.
3. Press the key labeled **ENT** (Enter) to retrieve the program.
4. Press the key labeled **RCL NXT** (Recall Next) to recall the next program sequentially (i.e., Program 03, then 04, etc.)

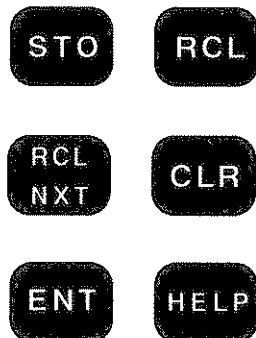

3-3.2.3 HOW TO RECALL WHAT YOU HAVE STORED

The **RECALL** key is used to recall a test set-up or other parameters which have been stored in a particular register.

Pressing the **RCL** key will bring up the following display on the Model 930A:

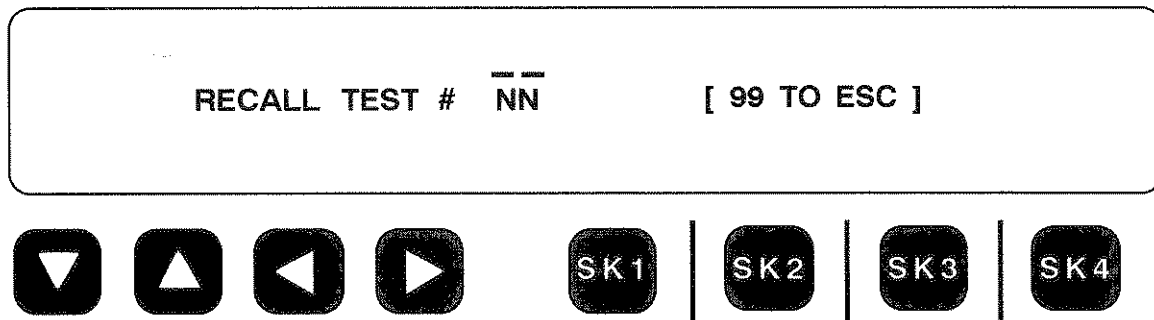

Use the numeric keypad to input the number (between 00 and 39) of the storage location of the desired test set-up. Press **ENTER** or a softkey to recall the set-up stored in that location.

To exit without recalling a set-up, input "99" and press **ENTER**.

3-3.2.4 EXAMPLE OF STORING AND RECALLING

The following simple example will serve to illustrate the use of the **STORE**, **RECALL**, and **RECALL NEXT** keys:



EXAMPLE: One way to measure the loss on a line with the 930A is to perform the following steps:

Press the  **Trunk Type** function key.

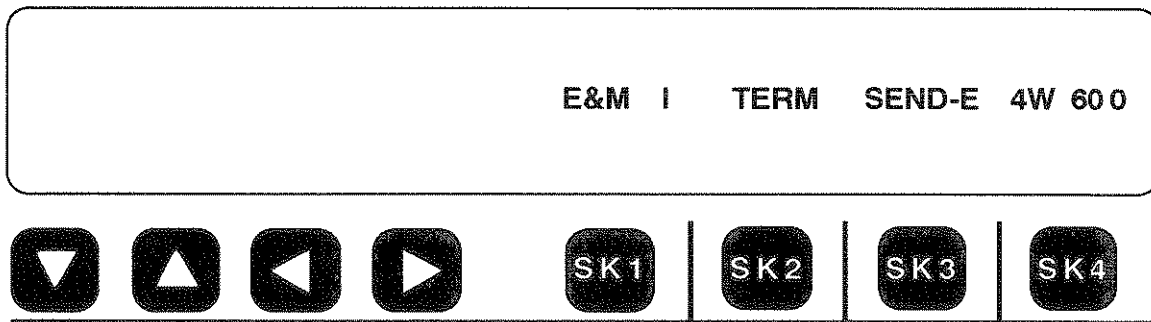
The following 930A display will appear depending upon the Trunk Type selected.



Set up the Trunk Type to the correct condition (assume that the previously displayed trunk type information is correct for this example) and store it in register location 1.

Press the STORE  key, then press  and then .

Press the DIAL/RING  **Dial/Ring** function key.

Go off-hook by placing the hookswitch in the **OFF-HOOK** position and, using the keypad, enter the telephone number of the local milliwatt test line. The 930A will dial the number as it is entered.

An example 930A display follows:

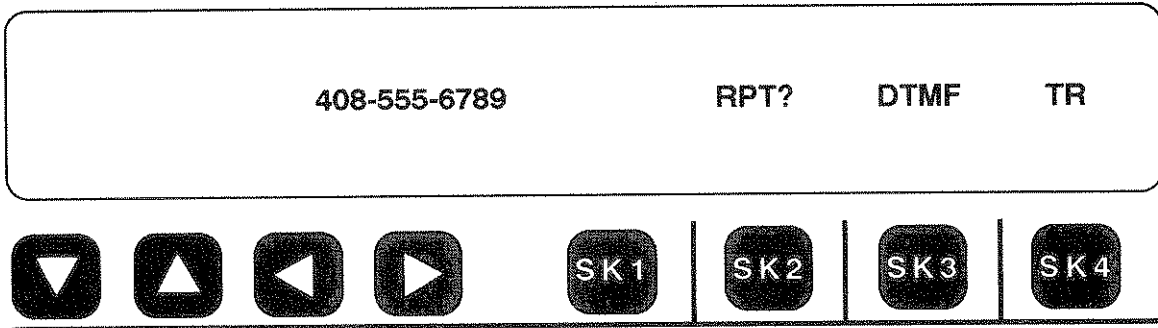

Store the test line phone number in register location 2.

Press the STORE **STO** key and then the ENTER **ENT** key.

Press the Measure Tone  **Measure Tone** function key.

Measure the level being sent when the tone is audible.

A typical 930A display is shown:

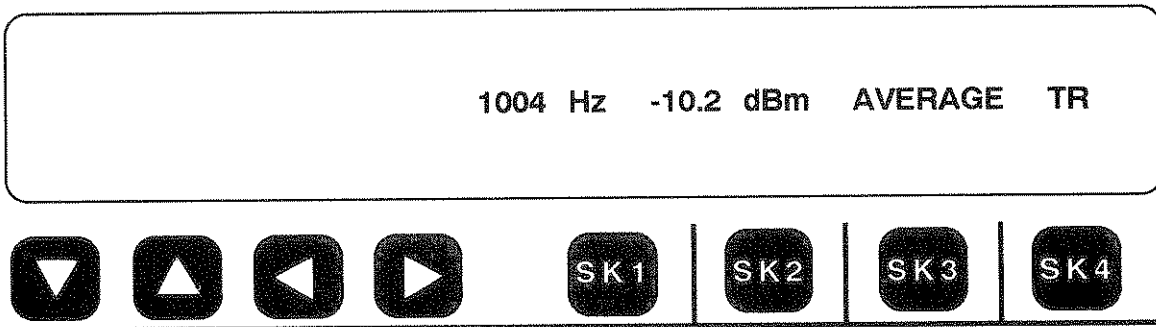







Store the **Measure Tone** Function set-up in register location 3.

Press the STORE **STO** key and then the ENTER **ENT** key.

The test has now been performed and the test sequence has also been stored. The entire test can now be rerun at any time with only six simple keystrokes as shown on the next page.

To rerun the test sequence in the previous example follow the steps below (Go **OFF-HOOK** after step 3).

| STEPS | PRESS KEY | DESCRIPTION |
|-------|---|---------------------------|
| 1 |  | |
| 2 |  | |
| 3 |  | Recalls Trunk Type Set-Up |
| 4 |  | Recalls Milliwatt Number |
| 5 |  | Places the Call |
| 6 |  | Calls Up Measure Tone |

The displayed measurement is the loss on the line. A typical display of measured tone would appear below:

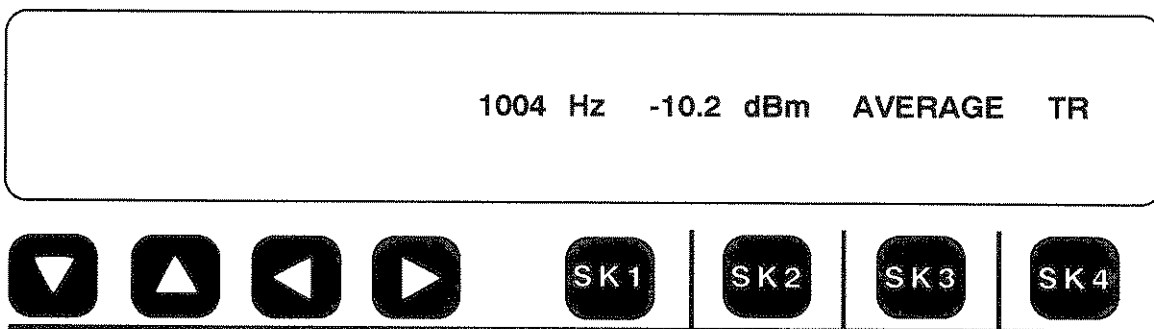

To use the **HELP**, **ENTER** or **CLEAR** keys:

1. Press the key labeled **HELP** for step by step instructions of set-up procedures for any of the function keys except the Option Menu key. The set-up selections are made using the **softkeys** under the display.
2. Press the key labeled **ENT** (Enter) to complete a numeric entry.
3. Press the key labeled **CLR** (Clear) to clear out or initialize a sequence as in **DIAL/RING** mode. It does **NOT** clear numeric values to zero.

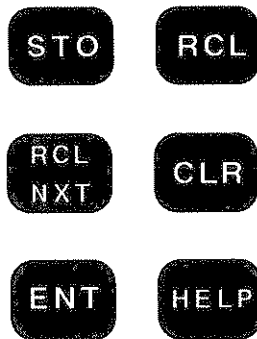

3-3.2.5 HOW TO ENTER AND CLEAR DATA

The Model 930A's **ENTER** key operates exactly like a calculator. Once the correct numeric data has been input for a particular test or program, all you do is press **ENT** and the data is accepted. In some cases, you cannot advance to the next operation until you have completed your data entry by pressing the **ENTER** key. Pressing **ENTER** will also cause a print out of the current display if a printer is connected to the 930A in Printer Remote mode.

The **CLEAR** key is used to clear or initialize sequences and allow new entries to be made. It is **not** used to clear a numeric value to zero. This is done by simply entering a zero. The **CLR** key is used to clear sequences of variable length, such as a string of digits to be outputted in the **DIAL/RING** mode.

The only functions which require the use of the **CLEAR** key, and which are covered in this manual, are Dial/Ring (Section 3-5), Send Digit Sequences (Section 5-2), Digit Receiver (Section 5-4) and DS-0/DS-1 Errors (Sections 4-2).

3-3.2.6 HOW TO USE THE HELP KEY

The **HELP** key is provided to assist you in operating the Model 930A. Any time you get stuck, pressing the **HELP** key provides a series of screens which generally lead you, step-by-step, through the function. **Remember** that when you press the **HELP** key, the **softkeys** are controlling each selection. So, as each screen appears, you must choose the correct parameter for your test by pressing the **softkey** directly under the displayed value, or item, you want. **HELP** is available in each function from **TRUNK TYPE** down to **MEASURE NOISE**. **HELP** is not available for the individual functions under the **OPTION MENU** function key. This is due to the large number of functions under this key and the limitations on memory.

To use the Hookswitch:

1. The Hookswitch controls whether the 930A is “**on-hook**” or “**off-hook**.” On 2- and 4-wire analog trunks it also engages the holding coils. (To output pulse digits, send tones, etc., the 930A must be **off-hook** in most cases.)*
2. The Supervision LEDs show the status of the Originate and Terminate ends of the circuit.

* In some Trunk Types and directions (such as Loop Contact), the 930A must be “**Off-hook**” to send tones and output pulse digits.

3-3.3 USING THE HOOKSWITCH TO SEIZE AND RELEASE TRUNKS

The chrome switch located to the right of the Special Function keys, as shown in Figure 3-1, is the **Hookswitch**. The four LED's above the Hookswitch are the Supervision Lamps.

ORIG **TERM**

Off Hook

On Hook

Off Hook



On Hook

A WORD ABOUT SUPERVISION

The Supervision Lamps are labeled "**ORIG**" and "**TERM.**" The 930A is the "**Originating**" end of the circuit when sending digits. The 930A is the "**Terminating**" end when receiving digits. In certain applications it is less obvious which end is "**Originating**" and which is "**Terminating.**" An example of this might be Foreign Exchange circuits. By convention, then, the "**ORIG**" lamp always shows the 930A status, unless it is receiving digits.

NOTE: If the 930A has been placed in a **REMOTE CONTROL** mode, the Hookswitch is inoperative unless **STANDBY** mode is selected (Section 6-1.1).

The operation of the Hookswitch on **PCM** trunks is described in Section IV.

3.4.1 HOW TO SELECT THE TRUNK TYPE (Metallic [Analog] Trunk Types:)

1. Press the **TRUNK TYPE** function key.
2. Use the **UP/DOWN** arrow keys or Softkey 1 to scroll through and select the desired trunk type.
3. Press Softkey 4 to select 2-wire or 4-wire operation and the appropriate impedance (150, 600, 900 or 1200 Ohms)
4. Press Softkey 3 to select the correct simulation for the testing direction (**BATTERY** to simulate the Central Office toward the subscriber loop, **CONTACT** to simulate the subscriber toward the Central Office, **SEND-M** to be the Originate office or **SEND-E** to be the Terminate office).
5. Press Softkey 2 to select **TERMINATED** or **BRIDGED** operation as appropriate.

Pressing the **TRUNK TYPE** key will cause the 930A to display the current Trunk Type and configuration in use. A typical display is shown below:

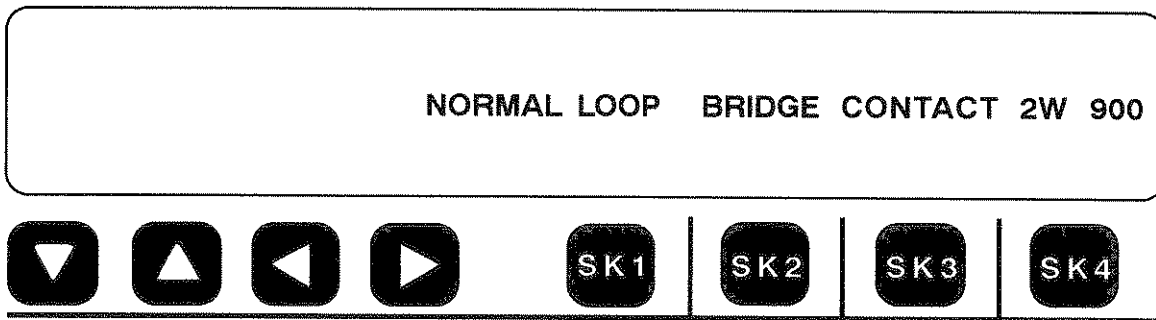

When power is first applied to the 930A it will default to the **Trunk Type** function.

3-4.2 HOW TO SET-UP A TRUNK TYPE

Pressing the **TRUNK TYPE** function key will produce a display similar to the example below depending upon the **Trunk Type** previously selected.

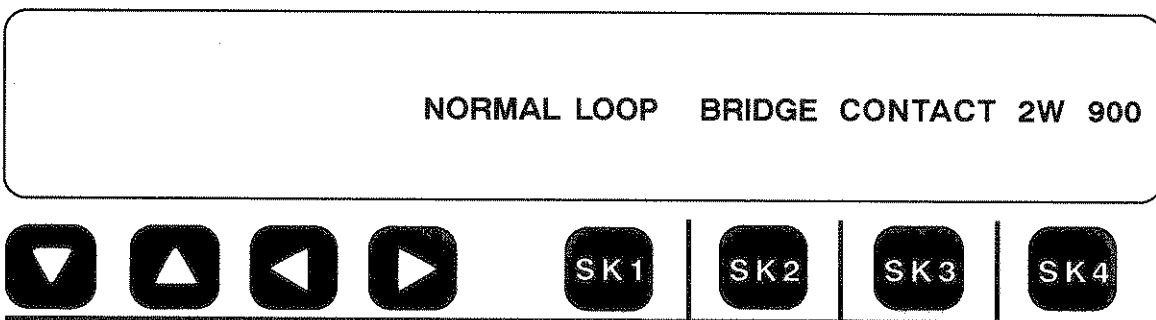

The softkeys have been labeled as **SK1** through **SK4** in the examples in this manual. They are blank on the actual 930A front panel.

Suppose that you need to test an **E&M** type trunk. The operation of the arrow keys and softkeys necessary to accomplish this is described in the following example.

3-4.2.1 EXAMPLE: SETTING UP AN E&M TRUNK

We want to terminate a 4-wire **E&M Type 1** trunk for this example. Suppose that the **TRUNK TYPE** function key has been pressed and we are starting from the **Loop Start** trunk displayed on the previous page.

NORMAL LOOP BRIDGE CONTACT 2W 900



Press either the **UP** or **DOWN** Arrow keys, or Softkey 1 (**SK1**) and page through the various Trunk Types. Use the **UP** Arrow key and scroll from Loop Start through Ground Start and then to **E&M**. When you get to the **E&M** trunks, the display below will appear:

E&M I BRIDGE SEND-M 2W 900



To change the trunk and impedance, press Softkey 4 (**SK4**) to page through the various combinations until you get to **4W 600** Ohm which is the most common impedance for **4-wire E&M**. The display below will appear:

E&M I BRIDGE SEND-M 4W 600



Determine whether to send supervision on the **M-Lead** or the **E-lead**. To simulate the **originating** end of the circuit, send on the **M-Lead**. To simulate the **terminating** end, send on the **E-Lead**. The display below will appear:

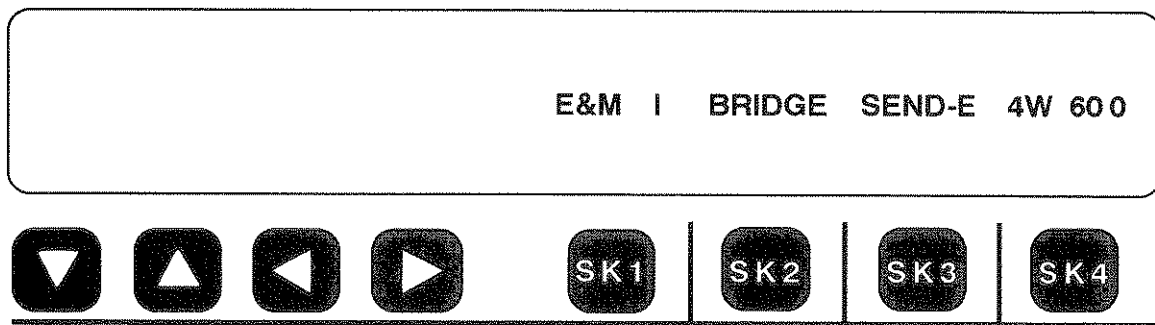

To terminate the circuit, change from Bridge to Terminate mode by pressing Softkey 2 which changes the display to:

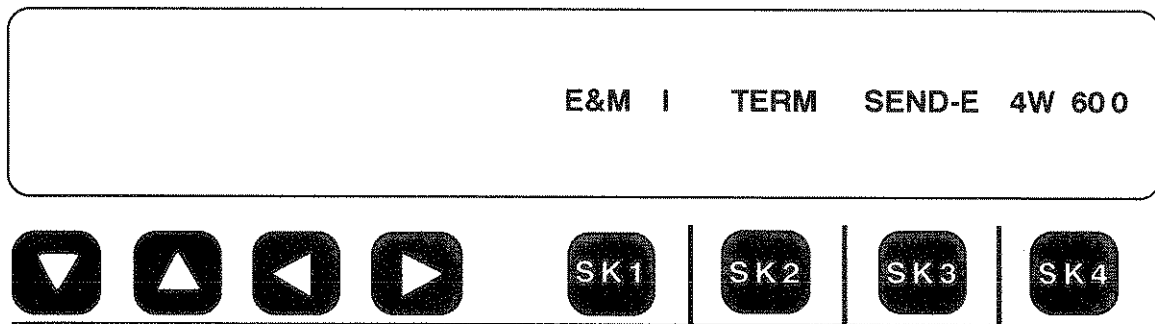

The 930A is now ready to terminate a **4-wire E&M Type I** trunk and send supervision on the **E-Lead**. The following details apply only to operation of the 930A front panel keys in the **TRUNK TYPE** function and only for Analog trunks.

1. The Numeric Keypad is inactive.
2. The **LEFT/RIGHT** Arrow keys are inactive.
3. The **UP/DOWN** Arrow keys roll through the available trunk types.
4. Softkey 1 is a wheel selecting Trunk Type. It has the same effect as the **UP** arrow key.
5. Softkey 2 toggles between Bridge and Terminate.
When Terminated, the 930A simulates one end of a circuit.
In Bridge mode, the 930A passively monitors the circuit.
6. Softkey 3 is a wheel selecting which end of the circuit the 930A simulates in the Terminate mode. In Loop or Ground Start this may be either **CONTACT** (a telephone or PBX) or **BATTERY** (Central Office). In **E&M**, this may be either **Send-E** or **Send-M**, indicating which lead the 930A is using to send supervision.
7. Softkey 4 is a wheel selecting 2- or 4-wire circuits and 150, 600, 900, or 1200 Ohm impedances.

NOTE:

Changing trunk types or changing from 2W to 4W operation automatically places the 930A in the **BRIDGE** mode. In the Bridge mode, the 930A does not send supervision. The Supervision Lamp marked "**ORIG**" shows the end of the circuit which the 930A would simulate if it were in "**TERM**" mode.

3-4.3 WHERE TO FIND OPTIONAL TRUNK TYPES

There are several options which can be purchased for the 930A to expand its capabilities. These include testing T1 (**DS-1 PCM**) carrier trunks, trunks employing **SF** supervision, or interfacing directly with the Secondary Trunk Test Panel (**STTP**) used with the No. 1/1A ESS. Pressing the **TRUNK TYPE** Function key will display the current trunk type. Use the **UP/DOWN** arrow keys, or Softkey 1, to page through the available trunk types until the Model 930A's display is:

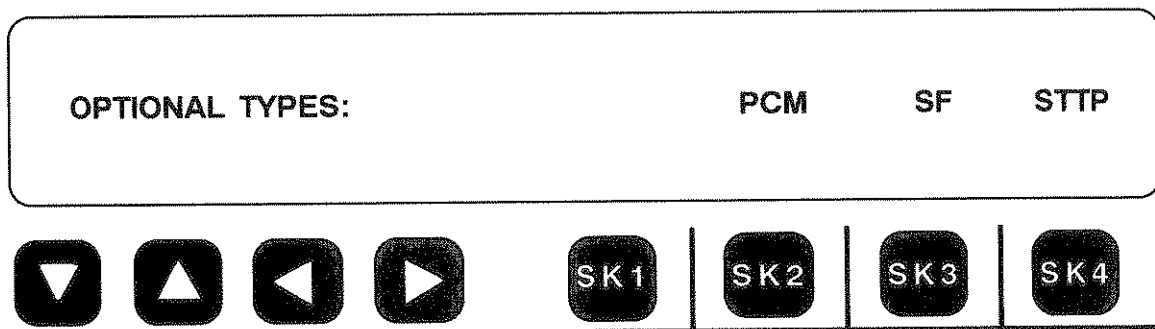

If an option has not been installed on the 930A, and an attempt to select it by pressing the softkey below occurs, it will cause the Model 930A to flash a "**NOT INSTALLED**" message on the display. If any or all of these options have been purchased, then pressing the softkey located beneath the displayed optional trunk type will cause it to be selected.

To select **SF Supervision** Trunk Type:

1. Press the **TRUNK TYPE** function key.
2. Press Softkey 1 or use the **UP/DOWN** arrow keys to select the display entitled "**OPTIONAL TYPES**".
3. Press Softkey 3 (under **SF**) to select **SF Supervision**.
4. Press Softkey 4 to select the impedance (usually **4W 600**).
5. Press Softkey 2 to send on **Tip/Ring** or **Tip1/Ring1**.
6. Press Softkey 3 to select either **BRIDGE** or **TERMINATE** operation.
7. Use the Hookswitch to go "**Off Hook**".

3-4.4 SF SUPERVISION (OPTION 930A-02)

If Option 930A-02 **SF SUPERVISION** has been installed in the Model 930A, it can be accessed under the **TRUNK TYPE** key.

Press the Trunk Type   **Trunk Type** function key to display the currently selected Trunk Type.

Use the UP/DOWN   arrow keys to page through the available displays until the following display appears:

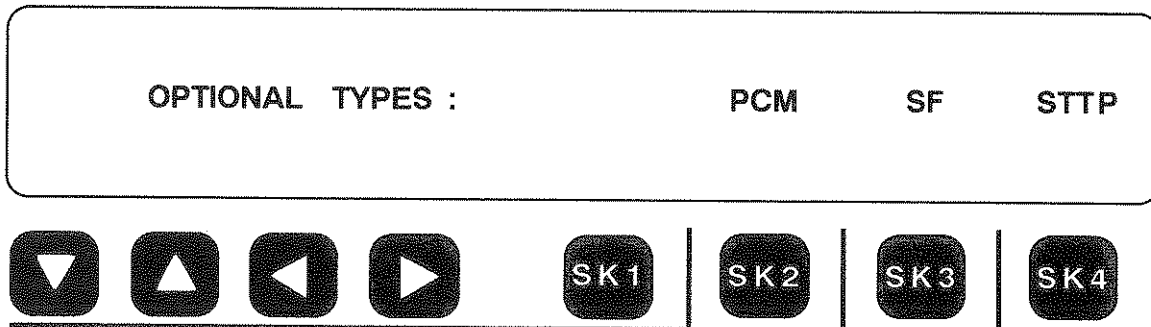

Press **Softkey 3** (under **SF**) to enter the **SF Supervision** Trunk Type. An example display is shown below:

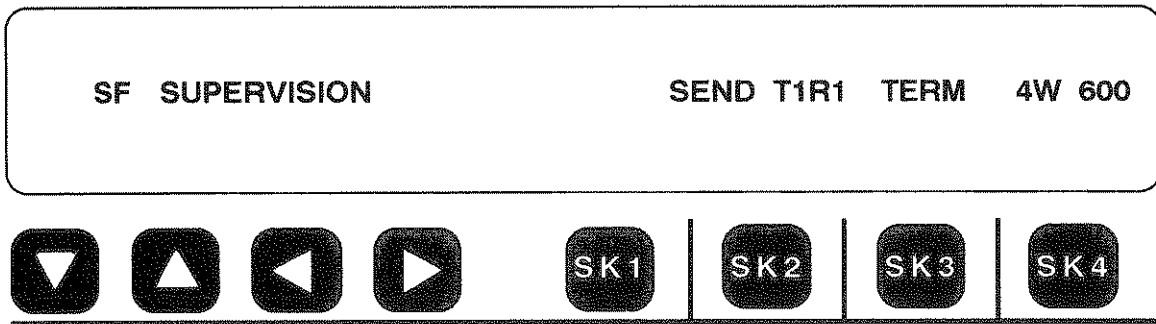

Single Frequency (SF) supervision sends a 2604 Hz tone to indicate an **On-Hook** condition. It is inherently a 4-wire trunk type and is now mainly used on special service trunks in the U.S. It has been largely displaced in the network by CCIS and SS7 signaling types.

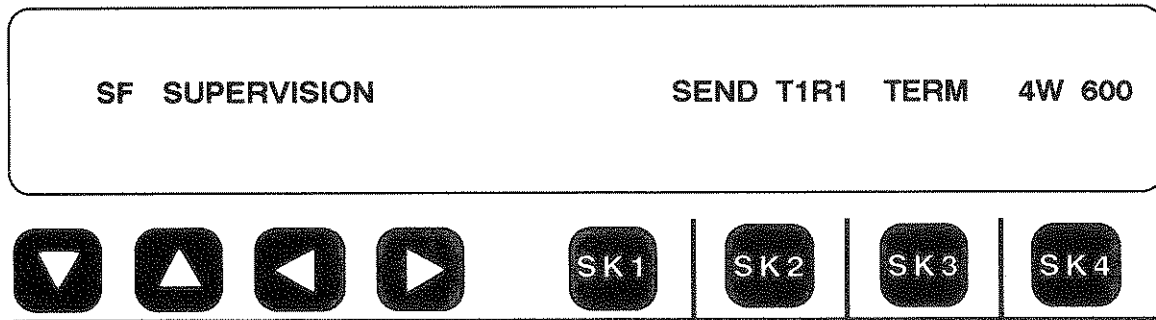

The front panel keys operate as follows:

The Arrow keys and Numeric keypad are inactive.

Softkey 2 toggles the Send direction between **TR** and **T1R1**.

Softkey 3 toggles between **BRIDGE** (Monitor) and **TERM** (Simulate).

Softkey 4 acts as a wheel allowing you to choose 150, 600, 900, or 1200 Ohm transmit and receive impedances.

In practice, the impedance selected will most often be 600 Ohms which is the typical 4-wire line impedance for analog transmission.







The Model 930A does not presently support 2-wire SF systems which use 2 tones (2404 and 2604 Hz, for example); nor can it be used to provide SF supervision on PCM systems. The SF option in the 930A does not support FXS/FXO supervision on SF trunks either. Future enhancements to the 930A may include these capabilities.

3-4.5 BASIC TEST FUNCTIONS

Some commonly performed tests are:

1. After selecting the correct trunk type, place the **Hookswitch** in the **OFF HOOK** position to draw Dial Tone.
2. To place a call, press the **DIAL/RING** Function key. Press the **HELP** key if unsure of operation.
3. To measure Return Loss, press the **RETURN LOSS** function key. Press the **HELP** key if unsure of operation.
4. To send a frequency at a specific level, press the **SEND TONE** function key. Press **HELP** if unsure of operation.
5. To measure the frequency and level of a received tone, press the **MEASURE TONE** function key.
6. To measure the noise level on a circuit, press the **MEASURE NOISE** function key. Press the **HELP** key if unsure of operation.

The six basic test functions built into all Model 930A's are controlled by the seven black keys arranged in a column along the left edge of the front panel of the Model 930A as shown in Figure 3-1. There is one key for each of the six basic test functions, and an "Option Menu" key for additional functions and future expansion of capabilities. The six basic test functions and the sections in which they are covered are:

| | | |
|---|-----------------|---------------|
|  | ○ Trunk Type | (Section 3-4) |
|  | ○ Dial/ Ring | (Section 3-5) |
|  | ○ Return Loss | (Section 3-6) |
|  | ○ Send Tone | (Section 3-7) |
|  | ○ Measure Tone | (Section 3-8) |
|  | ○ Measure Noise | (Section 3-9) |

Seventeen additional functions are standard with the 930A.



Option
Menu

(Section 3-10)

Some of these additional functions are: Modify Send Digits, Send Digit Sequences, DC Volt/Amp Meter, Supervision Threshold Adjustment, Supervision Monitor, Wink Timing, Frequency Sweep, Adjust TLP, Beep On Error, Dial-Up Test line, and Dial-Up Sweep. These functions are described in detail in Section V.

The 930A operates basically the same way in each trunk type and test function, whether it is a standard or optional feature.

The following sections attempt to lead you in an orderly manner from selecting the Trunk Type, to placing a call, to making the basic telephone measurements such as level, frequency, noise and return loss which are standard features. The more complex measurements, and trunks such as T1, which are purchased options for the 930A, are described in Sections IV and V.

To enter a telephone number and place a call:

1. Press the **DIAL/RING** function key.
2. Press Softkey 3 to select **MF**, **DTMF**, or **DP**, as appropriate.
3. Enter the number of the telephone being called using the numeric keypad.
4. If a 1 second pause is desired (to get an outside line at a PBX), press the **LEFT** Arrow key after the digit has been entered (i.e., 9-4087611000).
5. Place the Hookswitch in the **OFF HOOK** position.
6. Press Softkey 2 (under **RPT?**) to output the digit string.
7. Press the **CLR** (Clear) key to clear out a sequence before entering a new one.

NOTE: DIGITS ARE OUTPUTTED AS THEY ARE ENTERED IF THE 930A IS OFFHOOK

8. To talk over the trunk under test using a Lineman's Butt-In set, connect it to the terminals shown.
9. If a Central Office headset or handset is available, connect it to the Tel-Set jacks to talk over the trunk under test.

3-4.6 HOW TO CONNECT TEST CORDS TO THE 930A (REFER TO FIGURE 3-1)

Several types of configurator panels are available depending upon the options installed in the 930A. Refer back to Figure 2-3, page 2-6 for a description. Although the jacks may be located in different positions, a jack labeled "TR" or "PCM IN 1" for example, is connected and used the same on all configurator panels.

A 2-wire Loop Start, Ground Start, or Reverse Battery trunk is connected to the 930A at the type 310 jack labeled "TR".

A 4-wire trunk requires connections to the type 310 jacks labeled "TR" and "T1R1". If the trunk is an **E&M** trunk, the **E&M** lead test cord must be connected to the type 310 jack labeled "E/M" for Type I. If **E&M Types II** through **IV** are being tested, the signal battery/signal ground leads must be connected to the type 310 jack labeled "SB/SG".

If a **T-1 (DS-1) carrier** circuit is to be tested, the tiny telephone (bantam) jacks labeled "PCM IN 1" and "PCM OUT 1" are used for single-direction testing (Option 930A-08E). For **dual-direction drop and insert** testing, "PCM IN 2" and "PCM OUT 2" will also be used. This requires Option 930A-09E to be installed. The **310 A/P** configurator uses type 310 jacks instead of bantam jacks, but the function is the same.

3-5 HOW TO PLACE A CALL USING THE DIAL/RING FUNCTION

Once you have selected and set-up the correct **TRUNK TYPE**, as outlined in Section 3-4, you may want to place a call, and either talk on the trunk, or get a tone back from the local milliwatt generator.

You must know the number you want to call, but more importantly, you must know whether the digits will be outpulsed as **MF**, **DTMF** or **DP**. If you want to talk on the trunk, you will also need a lineman's Butt-In Set or a Tel-Set such as the type used at Central Office test panels.

To begin, the front panel Hookswitch should be **On-Hook**. Then, locate the **DIAL/RING** function key shown in Figure 3-1 and press it. The last entered mode and sequence will be displayed.

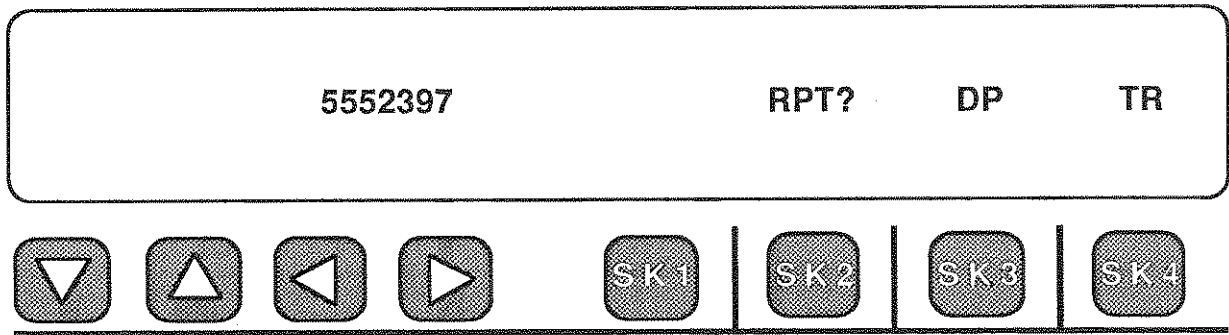

Since this is probably not the number, or even the type of call, you want to place now, you must set the display for the type of call you do want to make. As an example, you may want to place a Touchtone @ (DTMF) call to the number (408)761-1000, and have to dial a 1 first. **The first step** is to select **DTMF**. Press Softkey 3 (under **DP**) until **DTMF** appears. Notice that this also clears the old number. The display is shown below:

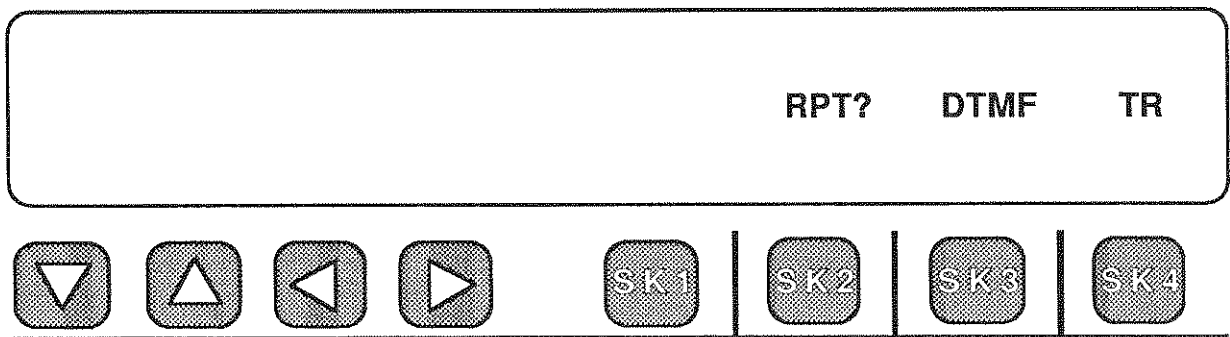

Now you are ready to enter the number. You can either go **OFF HOOK** first, using the front panel Hookswitch, in which case the digits are outpulsed as you dial, or you can enter the digits first and then go **OFF HOOK**. You would then press Softkey 2 (under **RPT?**) to have the 930A send the digits.

Enter the digits using the keypad. The **LEFT** Arrow key enters a 1 second pause. The display is shown below:

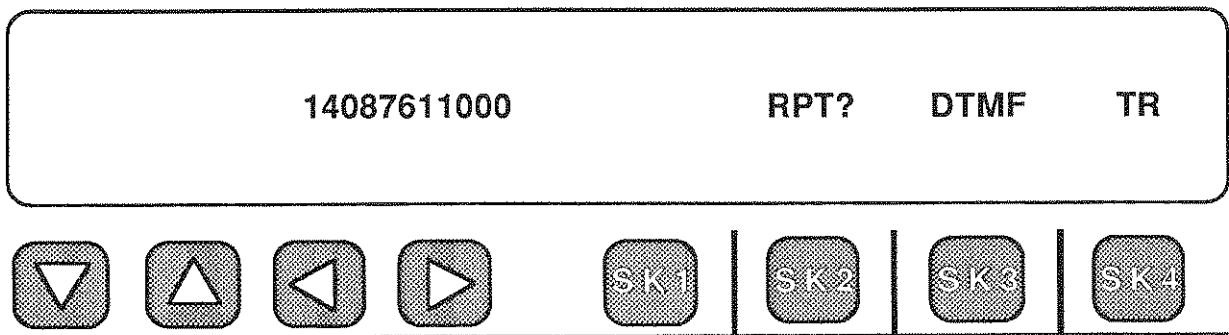

This mode and sequence can be stored for future use if it is a frequently dialed number. Use the **STORE** function.

Remember: When you are going to send **MF** digits you must first enter a **KP** (Key Pulse), then the numbers, and finally, end the string with an **ST** (Stop Pulse). For example, an **MF** digit string could be **KP004155551212ST**.

3-5.1 DETAILS OF DIAL/RING OPERATION

The functions of the various front panel keys, when the 930A is in the **DIAL/RING** mode, are outlined below:

The Left Arrow  key is used to insert

a one second pause into a digit sequence and appears on the display as a "-" between digits as in "9-14087611000".

Softkey 1 is inactive unless the 930A is in the **RING** mode (Option 930A-13 has been installed).

Softkey 2, labeled "**RPT?**", is asking the question, "Do you want to repeat the previously outputted digit sequence?" Pressing this key will output the digit sequence currently displayed.

Softkey 3 is a wheel and is used to select either Dial Pulse (**DP**), Multifrequency (**MF**), Dual-Tone Multifrequency (**DTMF**) or **RING**. Dial Pulse is not available when the 930A is simulating a CO (Supplying **BATTERY**). Changing the outputting mode will clear the display of any digit sequence.

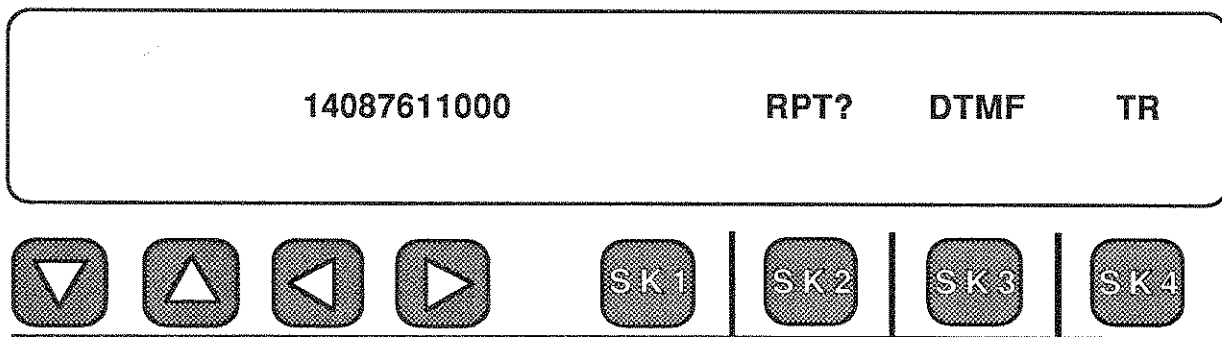

Softkey 4 is inactive. In the display above, it indicates which leads are in use for outputting (TR, T1R1, Send-E, Send-M, PCM 1 or PCM 2).

The Clear  key clears the display and erases any "remembered" digits.

The Enter  key is inactive.

The Numeric Keypad (including the ABCD keys) is the "dialer" and is used to enter digits.

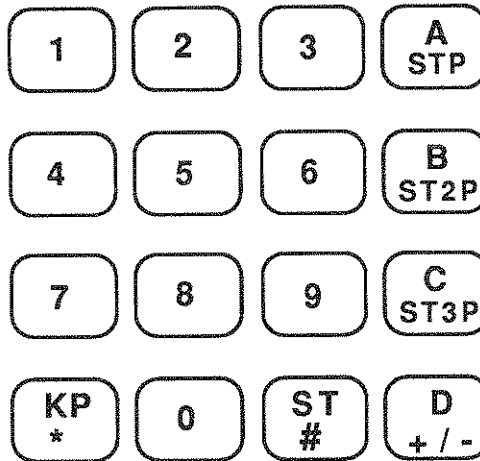

Off Hook

If the Hook Switch is in the OFF HOOK



On Hook

position, then the digits will be outputted as they are entered.

3-5.2 HOW TO STORE AND RECALL PHONE NUMBERS

You can easily store frequently used phone numbers for future recall and outpulsing. Pressing the **STO** (Store) key allows you to save the currently displayed digit sequence, its outpulsing mode (**MF**, **DTMF**, or **DP**), and any modifications which may have been made using **MODIFY DIAL/RING** (Option Menu 1). The parameters may be stored in any one of the 40 register locations (numbered from 00 to 39).

For example, suppose you want to store the unmodified **DTMF** sequence, shown in the following display, in register location 17.

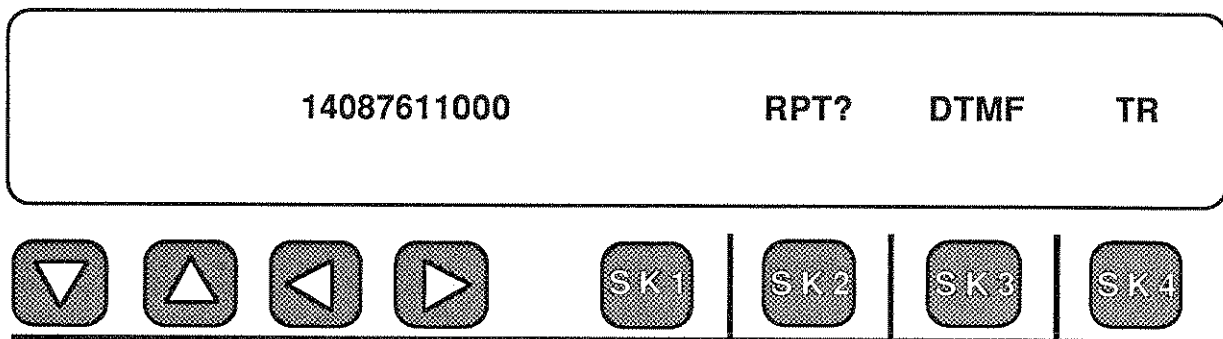

To store this number in register location 17, you do the following:

1. Press the STORE **STO** key.
2. Press **1** and then **7**.
3. Press the ENTER **ENT** key.

The procedure is the same for storing any phone number in any register location. Simply enter the desired two-digit memory location in place of the 17 used above.

To recall the digit sequence, simply press
the RECALL **RCL** key, then press **1**
and **7** then press the ENTER **ENT** key.

A REMINDER

The recalled digit sequence will set the outpulsed parameters to the values that were set when the digits were stored. Always check for the ">" prompt when recalling digits. Any modifications are available for inspection in **MODIFY DIAL/RING** (Menu Option 1).

Information on storing and recalling Multi-Wink sequences, such as those found in Equal Access, TSPS, and IDDD applications, is contained in Section V.

NOTE:

For IDDD applications in which a CCITT No. 5 MF sequence is being outpulsed, the required **KP2** pulse is equivalent to the **ST2P** pulse located on the **B** key on the 930A numeric keypad. Such an **IDDD MF** sequence would appear as:

ST2P11071738945ST

3-5.3 TRANSMISSION LEVEL POINT (TLP) COMPENSATION

Sometimes it is necessary to adjust the TLP of the 930A when sending or receiving digit strings, or when talking or listening on the trunk under test.

The 930A default TLP settings normally take care of this automatically when the Trunk Type is selected. However, in cases where the TLP on the trunk under test is not close to the default TLP settings, or the levels are too "hot," you will get invalid received levels for incoming dialed digits and the audio volume will be off as well.

In this case, the 930A lets you manually set the TLP level of the transmit and/or receive section to compensate. **Adjusting the Receive TLP** of the 930A has the effect of making the 930A digit receiver either more, or less, sensitive as required.

Changing the Transmit TLP affects the level of the dialed digits being sent by the 930A. Digits outputted from the 930A are normally sent at 7 dBm per tone below the Transmit TLP (i.e., at a 0 dB TLP the 930A sends individual **MF** and **DTMF** tones at -7.0 dBm, at a -16 dB TLP the 930A sends the tones at -23 dBm).

A detailed discussion of the TLP adjustment is contained in Section V. The Adjust TLP function is contained in Menu Option 30.

3-6 HOW TO MEASURE RETURN LOSS WITH THE 930A

Return Loss Measurements are made on both 2-Wire and 4-Wire circuits. When Return Loss Measurements are made on a 2-Wire circuit, the Return loss is the ratio of the transmitted power to the Reflected Power. On 4-Wire Circuits, Return Loss is the power ratio adjusted for any difference in the expected level (TLP) caused by the sending and receiving sides amplifiers, pads, or transhybrid loss (THL). Return loss normally requires a 600 or 900 Ohm Quiet Termination at the distant end. On Two-Wire circuits, a hybrid must be included as part of the Measuring circuit for accurate measurement of the reflected power.

Once you have set the 930A on the correct Trunk Type, it is easy to measure Return Loss. In most instances, you will be measuring Return Loss on a 4-wire trunk, although the 930A is also capable of measuring on 2-wire trunks as well.

Press the **RETURN LOSS** function key and the 930A will immediately enter the Return Loss measuring mode. The following display will appear.

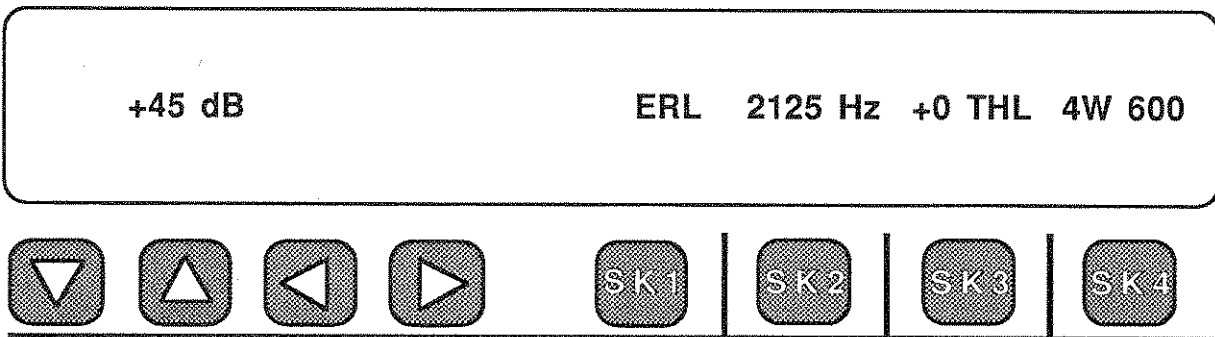

The 930A comes up with the pattern it was last sending which is the Echo Return Loss (**ERL**) pattern. It could have been Singing Return Loss High (**SRL-HI**), or Singing Return Loss Low (**SRL-LO**), or Sinewave (Oscillator) Return Loss. **Press Softkey 1** to page through the different patterns.

The reading you get will not be valid unless echo suppressors/cancellers, which may be present on long distance circuits, are disabled. Disable Echo Cancellers by pressing Softkey 2 (under 2125 Hz) and the 930A will send the echo suppressor disable tone momentarily.

3-6.1 DETAILS OF KEY OPERATION IN RETURN LOSS

The Model 930A is capable of Echo Return Loss (ERL), Singing Low (SRL-LO), Singing High (SRL-HI), and Oscillator or Structural (OSC) Return Loss measurements on both 2-wire and 4-wire circuits. Once the RETURN LOSS key has been pressed, the 930A will begin to send the selected Return Loss signal, and receive and display measurements. A typical display is shown below to help explain the key functions.

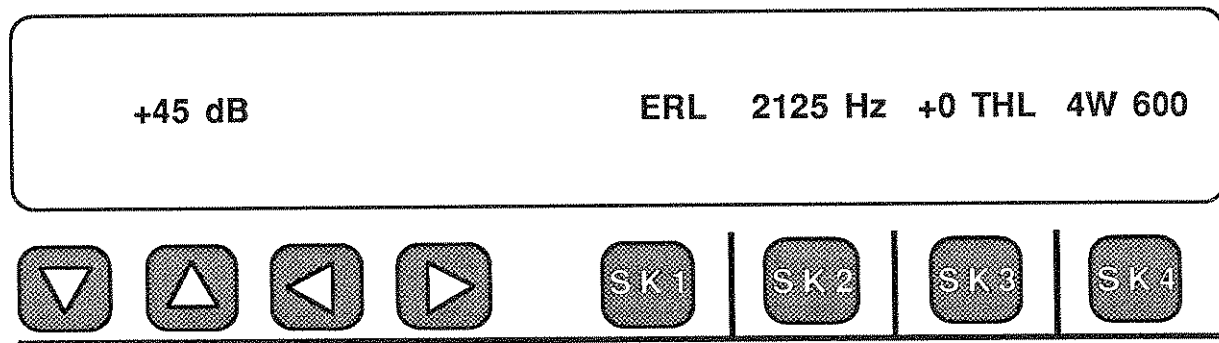

The operation of the front panel keys during Return Loss measurement are as follows:

Softkey 1 operates like a wheel. You select the Return Loss Pattern (ERL, SRL-LO, SRL-HI, or OSC), or the type of TR Termination (2-Wire only). The Return Loss patterns are sent at an average level of **10 dB** below the TLP. The expected Return loss measurement would typically be in the range from **15 to 45 dB**. It is reasonable to expect Return loss measurements to be **15-20 db** below the Transmitted test level. Note: If you see Return Loss results of **0 db** in 2-Wire or **50-70 db** in 4-Wire, you should consider that a problem exists with the Test connection such as an Open or Short in the circuit path. Typically, this measurement would be considered in-valid. This measurement is directly affected by the number of Repeaters in the circuit under test. The more Repeaters, the more stringent the test results should be. 1-2 repeaters require a minimum Return loss of 10dB per station, 3-4, 16dB per station and 5-8, 22 dB per station. Over 8 Repeaters requires 28dB per station.

IN ERL, SRL-LO AND SRL-HI:

Softkey 2 sends the echo-suppress tone displayed above it. A common frequency is 2125 Hz, but you should verify the correct value. Use the numeric keypad to enter the desired value of echo-suppress tone. Usually any value between 2000 Hz and 2250 Hz will work.

Softkey 3 is inactive in a 2-wire application. In a 4-wire circuit, this key selects Trans-Hybrid Loss (THL) as a parameter to be changed.

Softkey 4 is inactive. The circuit and impedance are displayed above it. These values are set in the Trunk Type function discussed in Section 3-4.

IN OSC (OSCILLATOR OR STRUCTURAL) MODE:

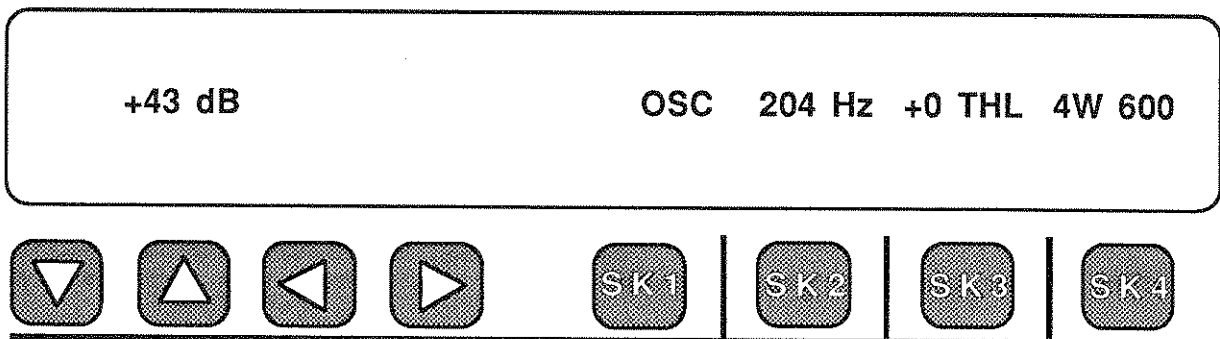

Input from the Numeric Keypad modifies the frequency of the tone being sent. Any desired frequency between 20 Hz and 5000 Hz may be entered. The tone is displayed above Softkey 2. The tone is sent at 0 dBm below the TLP level.

Softkeys 2 and 4 are inactive.

Softkey 3 affects the THL in the same manner discussed above.

IN TR TERMINATION (2-WIRE CIRCUITS ONLY):

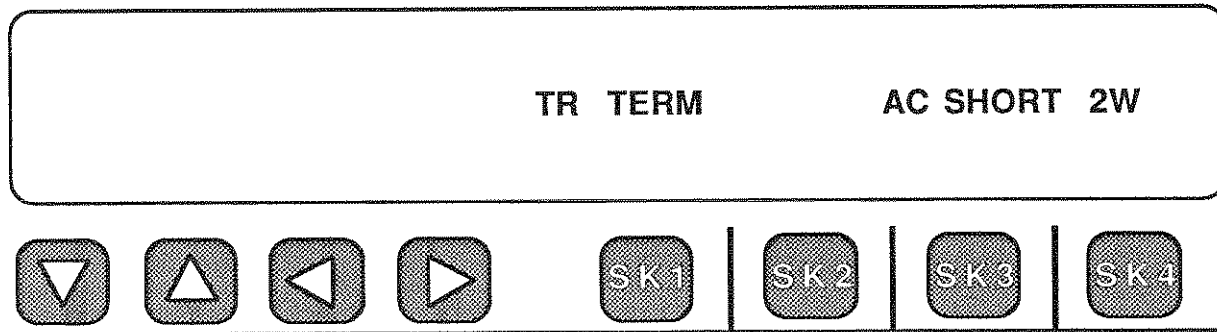

Softkey 2 is inactive.

Softkey 3 operates like a wheel which lets you select the type of termination (AC SHORT, AC OPEN, 600 ohm w/2.16 ufd, or 900 ohm w/ 2.16 ufd).

Softkey 4 is inactive.

NOTE: TR Termination is available only if the 930A is in a 2-wire mode as selected in **TRUNK TYPE**.

3-6.2 TRANS-HYBRID LOSS AND HOW TO MEASURE IT

The amount of loss across the Hybrid is used as a correction factor to the Return Loss measurement. The loss may be known from previous measurements (in which case it can simply be entered), or it may be measured by the 930A. In either case, the 930A will automatically correct its' Return Loss readings accordingly.

To measure Trans-Hybrid Loss, you must be able to get at the Hybrid because you will need to short out its 2-wire primary while you measure the 4-wire Return Loss at the secondary side. If you cannot do this, ignore **THL**. Leave it at the default of 0 dB.

1. Connect the 930A to the 4-wire side of the Hybrid, as close to it as practical, and set the **TRUNK TYPE** to the correct trunk for testing.
2. Short the 2-wire side of the Hybrid using a jumper cable.

3. Press the **RETURN LOSS** function key on the 930A. Use **ERL** or **OSC** set to 1004 Hz. This puts you at mid-band for the measurement.
4. Press Softkey 3 and the 930A will measure the **THL** and the value will appear over Softkey 3.
5. Press Softkey 3 again and the 930A will prepare to set the measured value in as the **THL** correction.
6. Press Softkey 3 again and the measured value will be accepted. If you want to enter something else don't press Softkey 3. Enter the number you want using the numeric keypad when the cursor is flashing over the measured value in Step 5.

3-7 HOW TO SEND A TONE FROM THE 930A

It's a lot faster if you just use the keys under the display and the numeric keypad to send what you want.

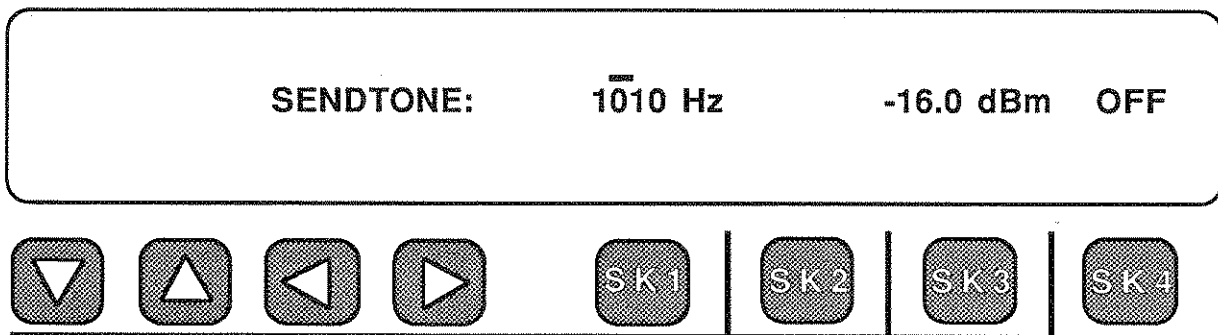

Note the cursor over the frequency display. If the cursor is over the level, press Softkey 1 to move it over the frequency. The sender is turned **OFF** in the above display.

To change the frequency to 1004 Hz, enter the numbers 1, 0, 0, and 4 from the keypad, press the **ENTER** key, and the display shown below is:

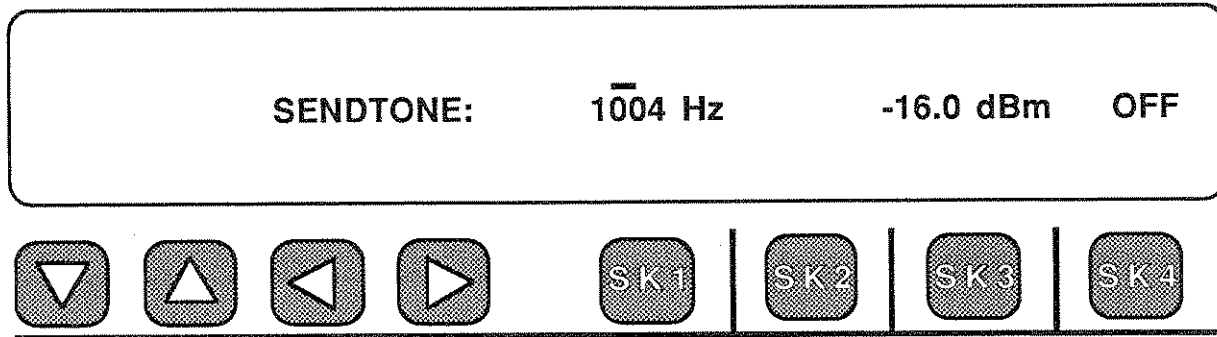

You can also use the **UP/DOWN** and **LEFT/RIGHT** Arrow keys to do the same thing.

To change the level, press Softkey 3 (under the level) and the cursor will move from the frequency to the level as shown below:

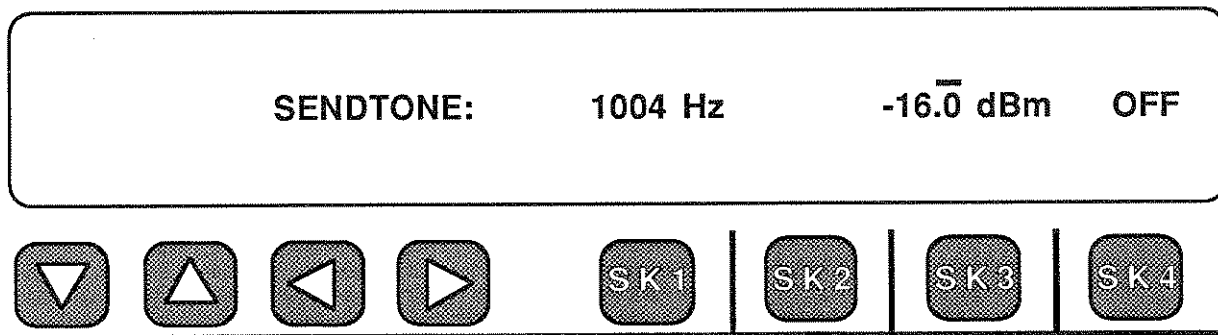

To change the level to 0 dBm, press the number 0 on the keypad, press the **ENTER** key, and the display will change to:

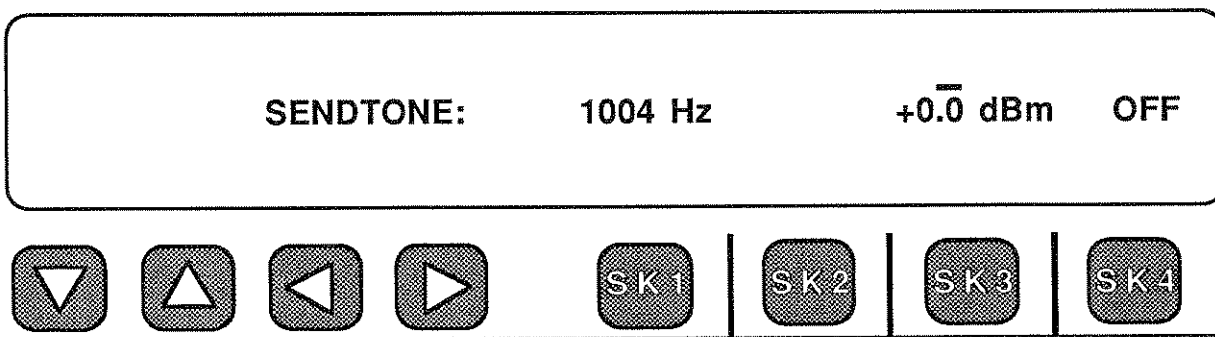

All that remains is to go **OFF HOOK**, press Softkey 4 (under **OFF**), and the display shown below is:

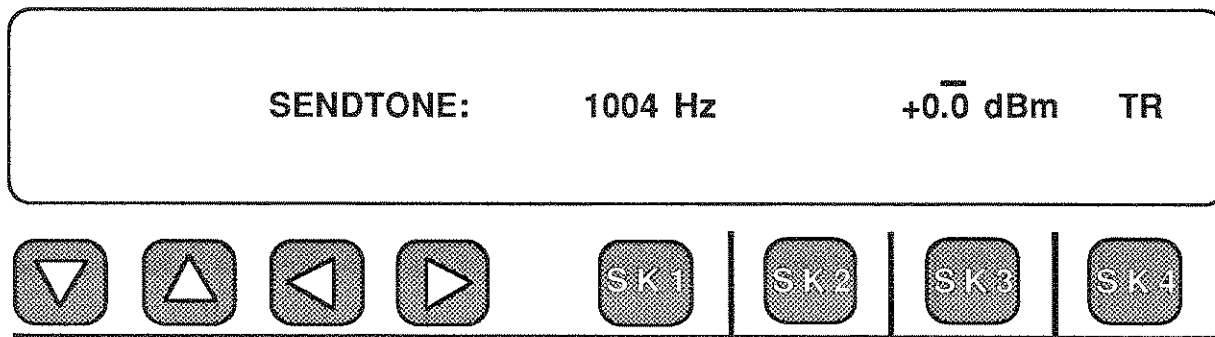

In this case, the 1004 Hz tone at 0.0 dBm level is being sent from the Tip-Ring (T/R) jack. Depending on the direction you were simulating this could have been T1R1, or it could have been PCM1 or PCM2 if you have either of the T1 PCM options.

3-7.1 DETAILS OF THE SEND TONE FUNCTION

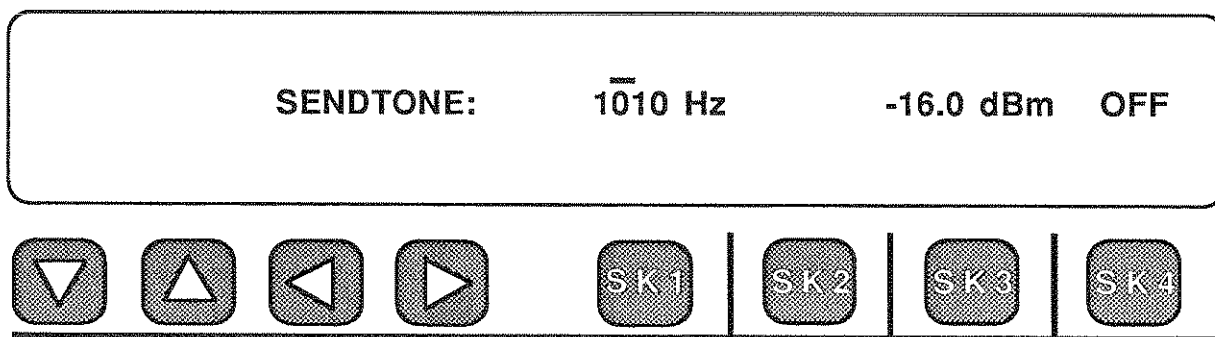

The functions of the front panel keys in the **SEND TONE** mode are:

Softkey 1 moves the cursor to the least significant digit of the frequency display. Numeric input will be treated as a frequency selection.

Softkey 2 is inactive.

Softkey 3 moves the cursor to the least significant digit of the level display. Numeric input will be treated as a level selection.

Softkey 4 toggles between Tone **ON** and Tone **OFF**. If the tone is **ON**, "**TR**", "**T1R1**", "**PCM1**", or "**PCM2**" will be displayed depending upon the Trunk Type and direction. If **OFF** is selected, no tone is sent and the 930A supplies quiet termination. Whenever the Model 930A is operating in a mode other than **SEND TONE** and a tone is being sent, the LED beside the **SEND TONE** function key will flash to alert you to the fact that tone is being sent. If no tone is desired, return to the **SEND TONE** function and use Softkey 4 to place the unit in Quiet Termination by selecting "**OFF**." The tone selected in **SEND TONE** is not sent in the **DIAL/RING** or **RETURN LOSS** functions.

The **LEFT/RIGHT Arrow keys** position the cursor within a selected field, either frequency or level, from least significant to most significant digit.

The **UP/DOWN Arrow keys** increment or decrement the frequency or level depending upon the position of the cursor. The step size depends upon the position of the cursor within the field and may be either 1, 10, 100, or 1000 Hz in frequency or 0.1, 1, or 10 dB in level.

Holding down the **UP** or **DOWN** Arrow keys will cause the Model 930A to sweep through the frequency or level steps. By selecting the appropriate frequency step size, you can generate a manual frequency sweep.

The Model 930A is capable of automatically sweeping tones over user-definable ranges. This standard feature is described in Section 5-10 since it is accessed under the **Option Menu** key.

To Measure a Received Tone:

1. Press the **MEASURE TONE** function key.
2. Press Softkey 2 to enter the **TLP** correction factor, measure in dBm, or set a 0 dB reference point for comparisons.
3. Use the numeric keypad to enter the **TLP** correction factor, if required.
4. Press Softkey 3 to change between **Average** and **RMS** detectors.

3-8 HOW TO MEASURE THE LEVEL AND FREQUENCY OF TONES

To measure and display the level and frequency of received tones, press the **MEASURE TONE** key.

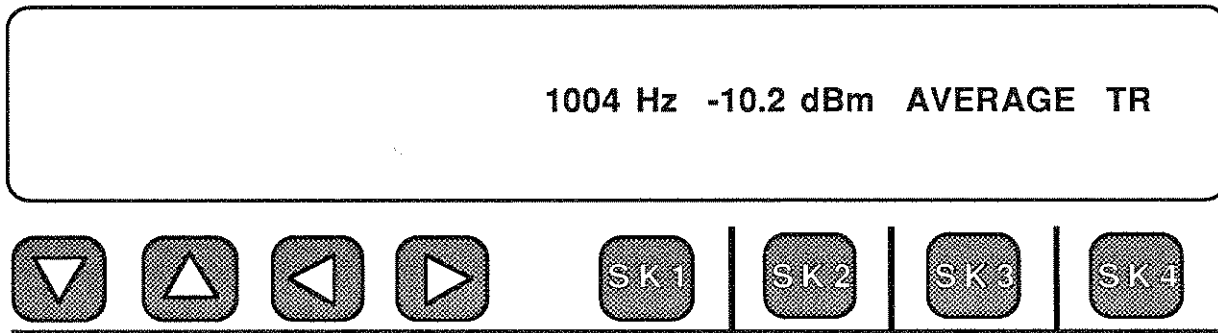

Usually, the absolute level in dBm is measured with an **Average** detector. These are the defaults for the **MEASURE TONE** function.

Pressing Softkey 3 will toggle between **Average** and **RMS** and the display would be:

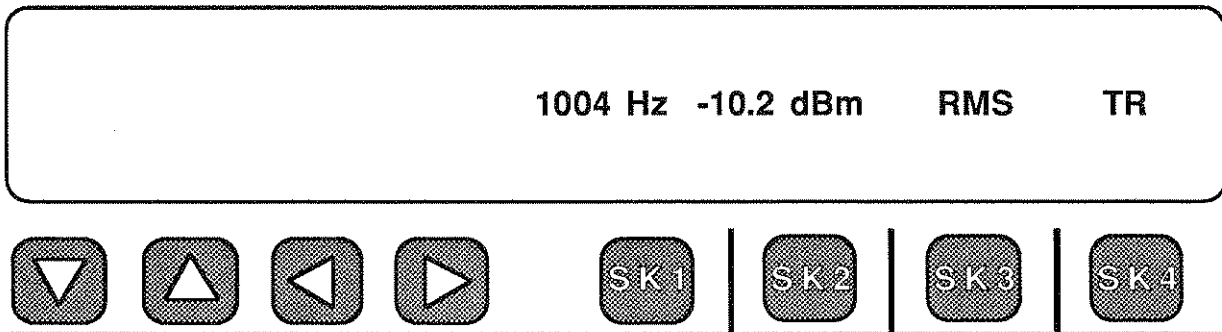

You will note that Softkeys 1 and 4 are inactive. Softkey 2 is active and allows you to set a 0 dB reference level for differential measurements or to measure relative to a specific TLP in dBm0.

3-8.1 DETAILS OF KEY OPERATION IN MEASURE TONE

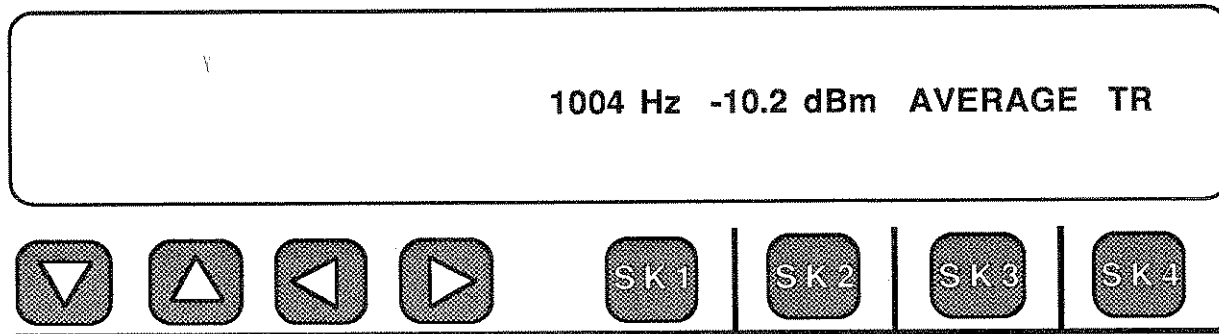

The functions of the front panel keys in the **MEASURE TONE** mode are:

Softkey 1 is inactive.

Softkey 4 is inactive. The display above it shows the input from which the measurements are being taken, i.e., **TR**, **T1R1**, and optionally, **PCM1** or **PCM2**.

Softkey 3 toggles between the **Average** and **RMS** detectors. **Average** is the most commonly used.

Softkey 2 acts like a wheel and enables you to select the 0 dB level relative to the current measurement. Initially the 930A displays the measurement in dBm and always returns to dBm when power is cycled. Press Softkey 2 once to lock in the current measured value as the 0 dB reference point. Pressing Softkey 2 again enables you to input a relative 0 numerically (numeric entry from the front panel keypad must be terminated by pressing **ENTER** or any softkey). Another press of Softkey 2 will return the 930A to dBm measurement. For convenience, the 930A displays measurements in dBm (absolute relative to 1 milliwatt), dB (relative to a measured 0), or dBm0 (relative to a specified 0 or transmission level point).

Accurate measurements can only be made if the proper impedance has been selected in **TRUNK TYPE** mode.

In Loop and Ground Start modes, the position of the Hookswitch can affect the AC Termination and, therefore, the measured level. Measurements in these trunk types should always be made with the 930A **OFF HOOK**.

To Measure Noise or Signal-to-Noise:

1. Press the **MEASURE NOISE** function key.
2. Press Softkey 2 to select weighting filter (**3 kHz FLAT**, **C-MESSAGE**, or **C-NOTCH**), or Signal-to-Noise (**S/N**).
3. Press Softkey 1 to select relative dB (dBrn or dBrnC), 0 dB reference point, or to enter TLP correction factor.
4. Press Softkey 4 to select Balanced or Noise-to-Ground measurements.

3-9 HOW TO MEASURE NOISE AND SIGNAL-TO-NOISE

Once you have set the correct Trunk Type in the 930A, you can use the **DIAL/RING** mode to call the far-end Type 100 test line. This will place a quiet termination on the line.

To measure Noise using the 930A, press the **MEASURE NOISE** function key. This causes the 930A to display the current measurements, filter weighting types, source, and balance.

The Model 930A measures **C-Message**, **C-Notched**, and **3 kHz Flat** weighted noise, as well as **Signal-to-Noise Ratio**, on 2- and 4-wire metallic circuits, or 64 kbps DS-0 channels (optional).

A typical display appears below:

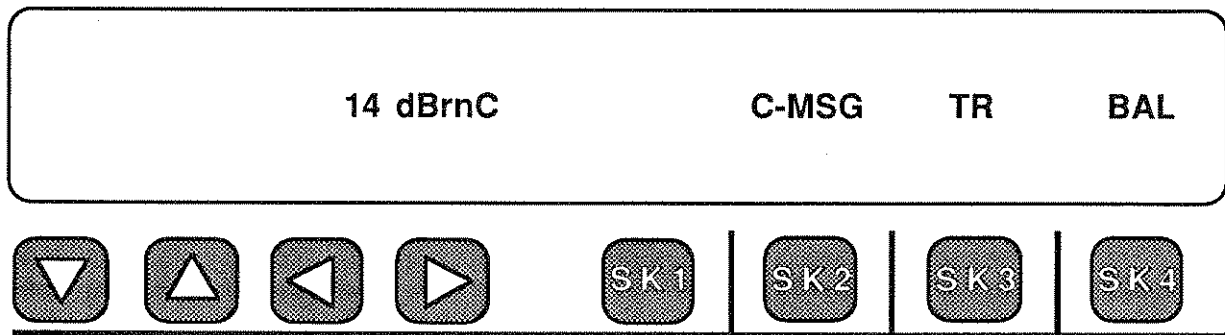

This is a measurement of C-Message weighted noise in dBrnC made at the Tip/Ring input in the balanced mode.

Pressing Softkey 2 will page you through the other filter types. Softkey 4 toggles you between balanced and noise-to-ground measurements.

3-9.1 EXAMPLE OF MEASURING SIGNAL-TO-NOISE

After setting up the 930A to the correct **TRUNK TYPE**, call the local milliwatt number to get a 1004 Hz tone sent back. Alternately, contact someone at the other end of the circuit and have them send 1004 Hz back. **Next**, select the **MEASURE NOISE** function.

Press the Measure Noise  **Measurekey.
Noise**

A typical display appears below:

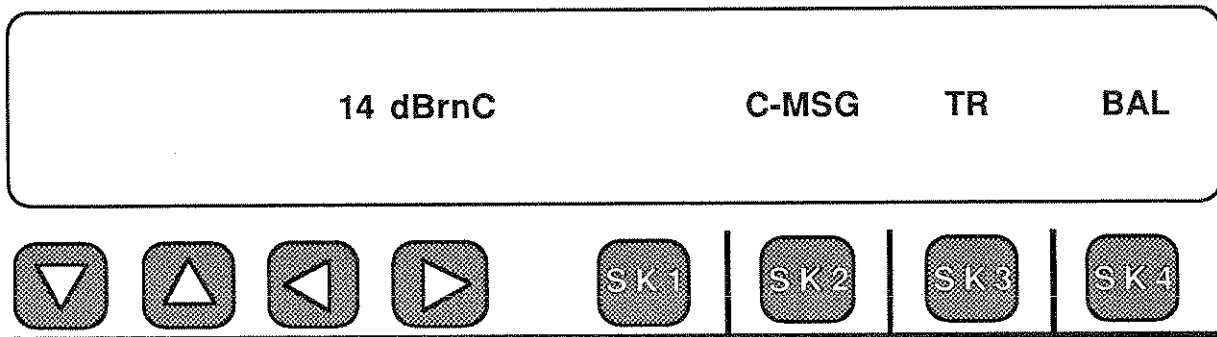

To select the **S/N** ratio display, press Softkey 2 until the display is:

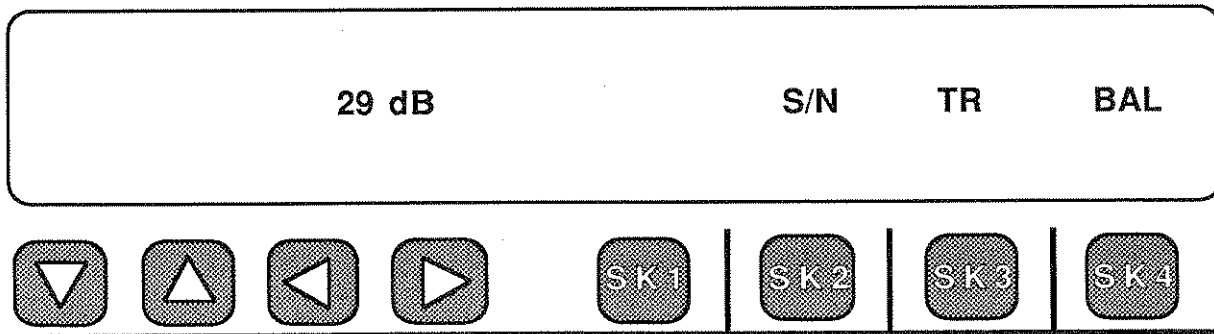

REMINDER: The **S/N** ratio measurement requires that a holding tone be present at the measuring end of the circuit. On 2-wire trunks this usually means making an end-to-end measurement with one test set supplying 1004 Hz from one end and the other test set measuring the **S/N** at the other end. On a 4-wire trunk, the far-end can be looped back. In this case the 930A can generate a 1004 Hz tone at the appropriate level and then measure the **S/N** ratio coming back.

3-9.2 DETAILS OF KEY OPERATION IN MEASURE NOISE

Softkey 1 acts as a wheel and enables you to select the measurement units. That is, dB_{rn} (absolute), dB (relative to the level being measured when dB was selected), or dB_{rn0} (relative to a level which is input numerically).

Softkey 2 acts as a wheel and allows you to select the type of weighting filter for a particular measurement. The choices are: **C-MESSAGE**, **C-NOTCH**, **3 kHz FLAT**, and **S/N**.

Softkey 3 is inactive. The input signal source (**TR**, **T1R1**, **PCM1**, or **PCM2**) is displayed above it.

Softkey 4 acts as a wheel and enables you to select balanced or Noise-to-Ground measurements on analog trunks. Optionally, on **PCM** trunks this window is labeled "**CHANNEL**" to indicate that the noise being measured is the noise on one channel and not the entire 24 channels. Softkey 4 is inactive on **PCM** trunks and also during **S/N** measurements which are only done as balanced measurements.

NOTE:

It is possible to set the relative zero for measurements in dB, using one weighting filter and then change to another filter. The display will then show the measurement in one filter relative to the other. This feature is particularly useful for measuring the notch depth of **C-NOTCH** filters.

4-0 WIDEBAND ANALOG OPERATION

4-1 INTRODUCTION

This section of the manual provides information on the operation of the Wideband feature of the 930A. The Wideband feature provides the capability to accomplish Wideband Transmission tests on metallic facilities in 2-or 4-Wire configurations.

4-2 SETUP PROCEDURE

The operation proceeds as follows:

1. Turn unit on. The 930A typically defaults to Normal Loop when a Cold-Boot is accomplished. Press Softkey 1 (SK1) to scroll through all the Trunk Types until the menu for Wideband appears. The screen is displayed below:

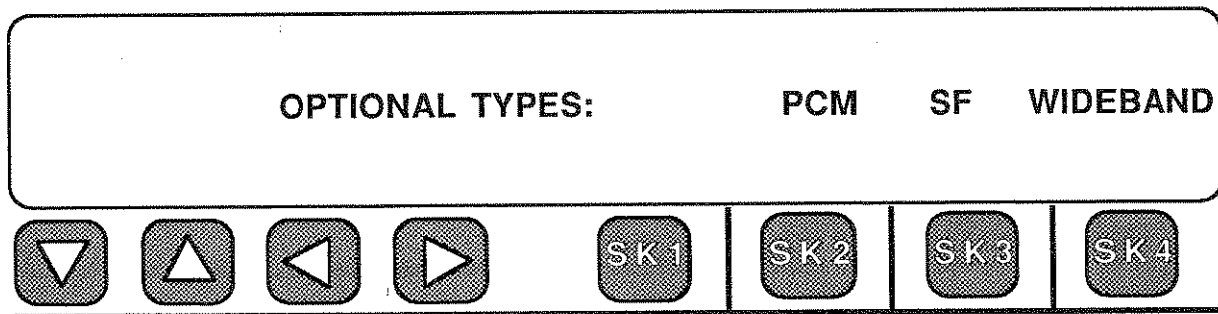

2. To select the Wideband Trunk Type, press **WIDEBAND** (SK4). The 930A will display the following screen below:

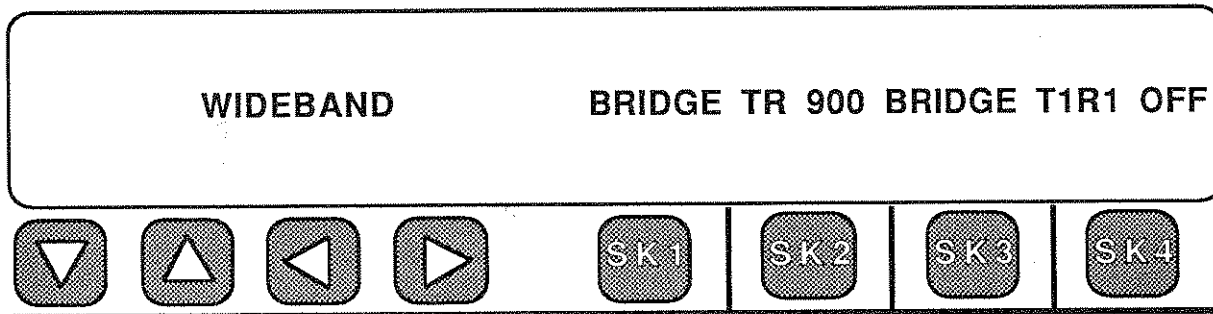

3. To test a 4-Wire Wideband facility, press **OFF** (SK4) to enable the Receive circuit until the following display occurs:

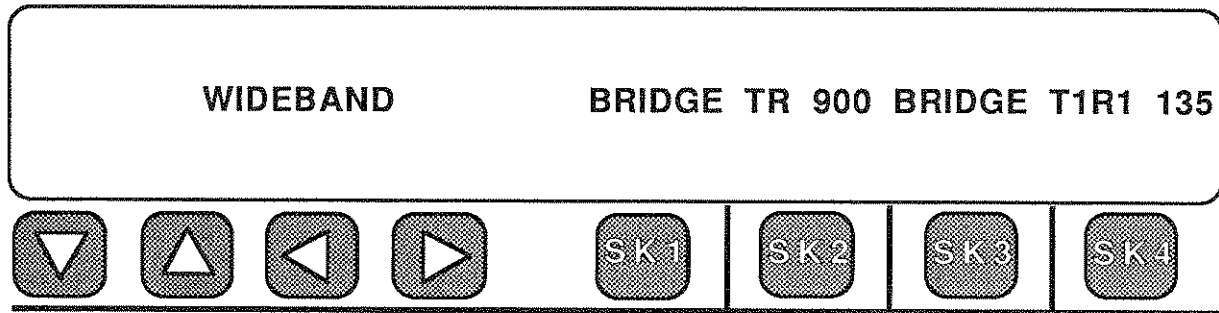

4. Press **BRIDGE** (SK3) until the following display occurs:

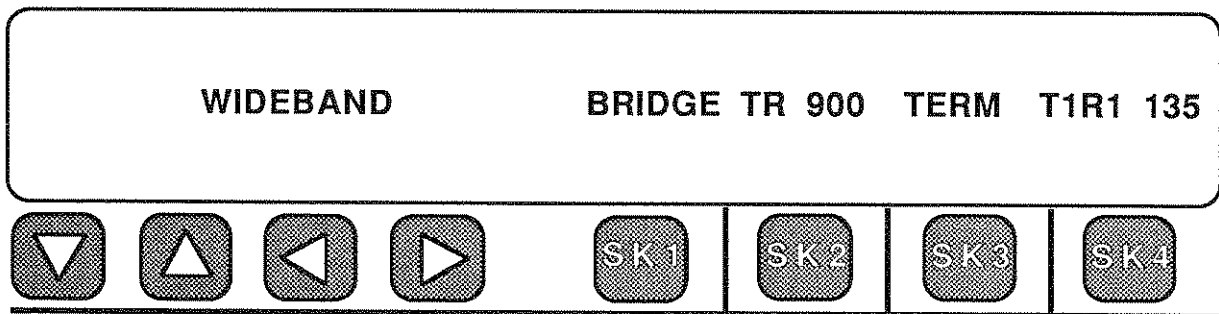

5. Press **TR 900** (SK2) until the following display occurs:

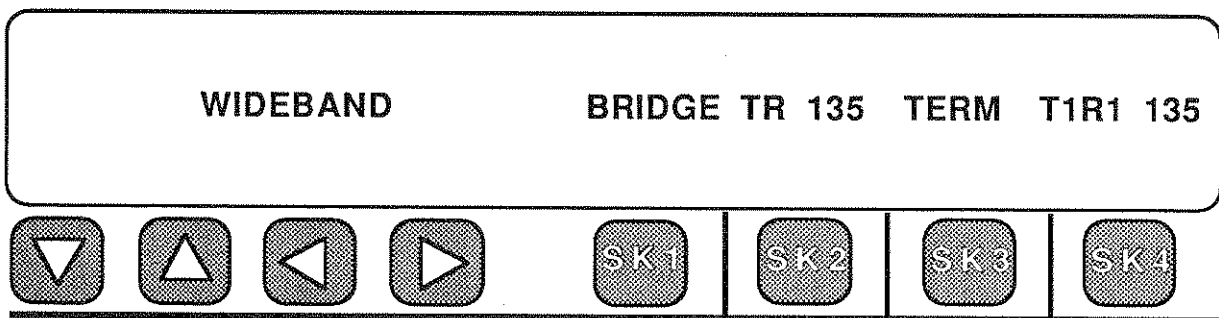

6. Press **BRIDGE** (SK1) until the following display occurs below:

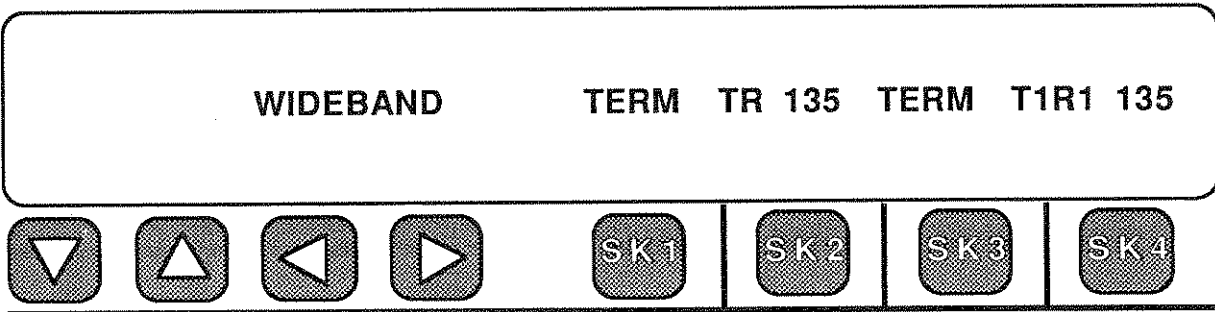

7. The Trunk Type selection is now complete. You can now continue to the connection of test cords and feature selection.
8. Refer to Figure 3-1 for connection of test cords. The normal connection of Wideband is as a 4-Wire trunk which requires connections to the type 310 jacks labeled "TR" and "T1R1". Be aware that T1R1 is considered Receive and TR Transmit for this test configuration as the final Trunk Type display indicates above.

4-3 WIDEBAND OPERATION

4-3.1 TRANSMISSION LEVEL POINT (TLP) COMPENSATION

The 930A default TLP settings normally set the **REC** and **XMIT** TLP to **0 dB**. This adjustment normally does not affect measurements in true Wideband since this is a Private Line test environment and voice signaling and dialing are not part of this operational functionality.

4-3.2 HOW TO MEASURE RETURN LOSS WITH THE 930A IN WIDEBAND.

The 930A is capable of ERL and SRL Return loss only in the voice band Trunk Type configuration. Typically, this is not a test requirement for Wideband because of the Private Line nature of Wideband. Typically, no 2/4-Wire Hybrids exist in this type of facility.

4-3.4 HOW TO SEND TONE FROM THE 930A IN WIDEBAND.

1. Select Send Tone. Notice the cursor over the last digit of the frequency previously selected, **1004** Hz.

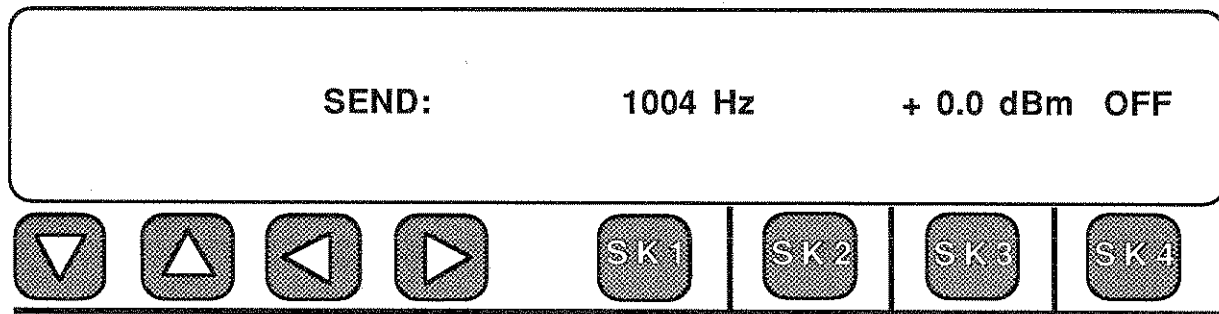

2. Press **OFF** (SK4) to turn on the Transmitter. To change the frequency, press (SK1). As an example, press **20000** Hz by using the Numeric pad. The following display will result:

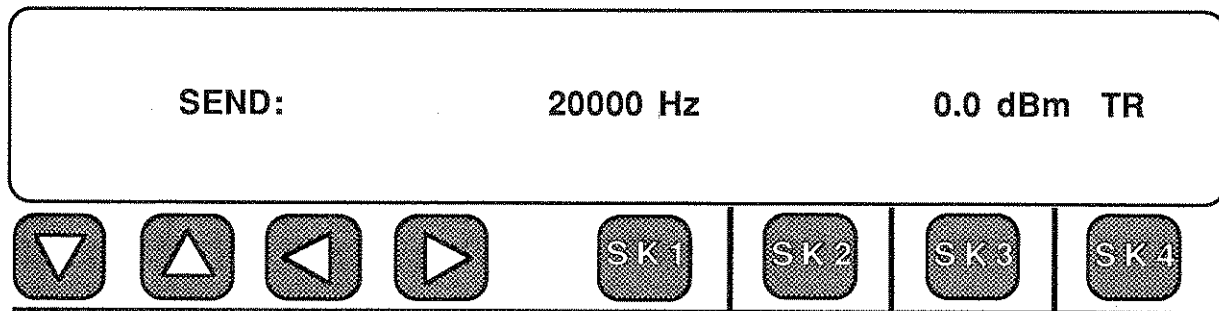

3. To change the level, press (SK3). Enter the required level (-16 dBm) by using the Numeric pad. The following will result below:

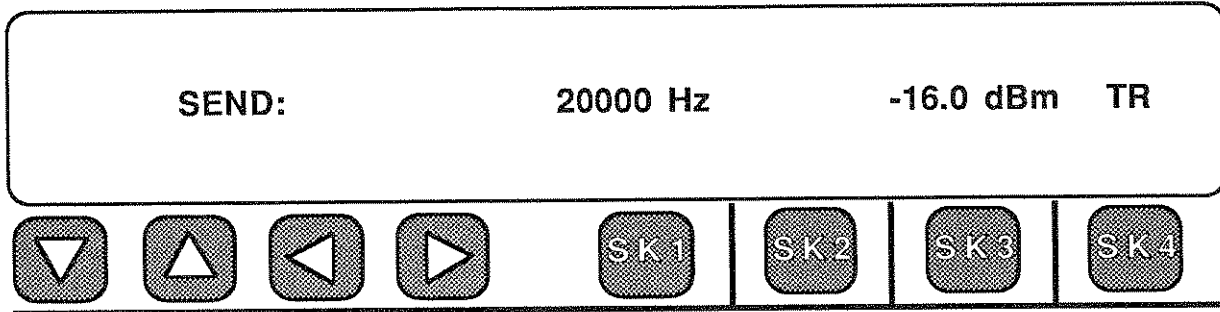

4. You are now transmitting 20K Hz at a -16 dBm on the TR jack to the Transmit line facility.

4-3.5 MEASURING TONE WITH THE 930A IN WIDEBAND

1. To measure and display the level and frequency of received tones, setup the 930A in the Wideband Trunk type as above. Press the **MEASURE TONE** function key. The following display will result.

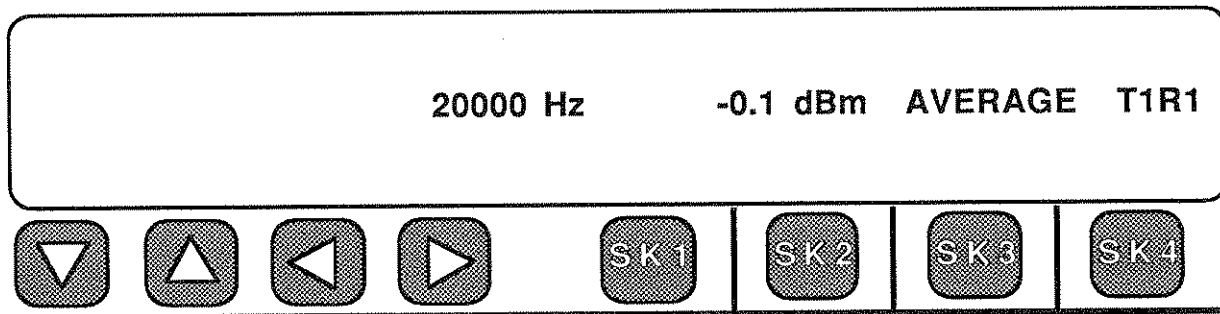

2. Usually, the absolute level in dBm is measured with an **AVERAGE** detector. These are the defaults for the **MEASURE TONE** function. You can toggle between **AVERAGE (Damped)** and **RMS** for your required measurement.
3. The display above shows the input from which the measurements are being taken. (**T1R1** in this example.)

4-3.6 HOW TO MEASURE NOISE WITH THE 930A IN WIDEBAND

1. To Measure noise, setup the 930A for Wideband Trunk Type as above, and press the **MEASURE NOISE** function key. This causes the 930A to display the current measurements, filter weighting types, source, and balance. See the display below:

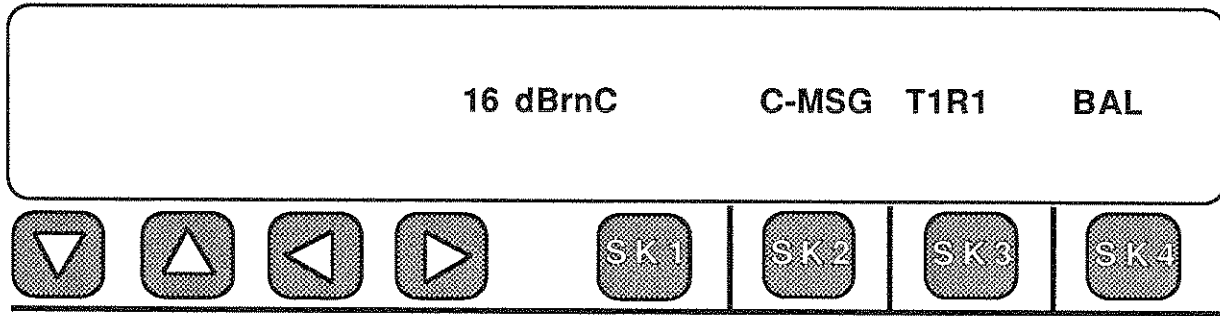

2. The 930A measures noise using the **PROGRAM**, **50 K-BIT**, and **50K BESSEL** filters in the Wideband Trunk Type. This can be done on 2-Wire or 4-Wire facilities. To change to Wideband filters, it is necessary to press the (SK2) Softkey until the **PROGRAM** selection is displayed. A typical measurement display is shown below:

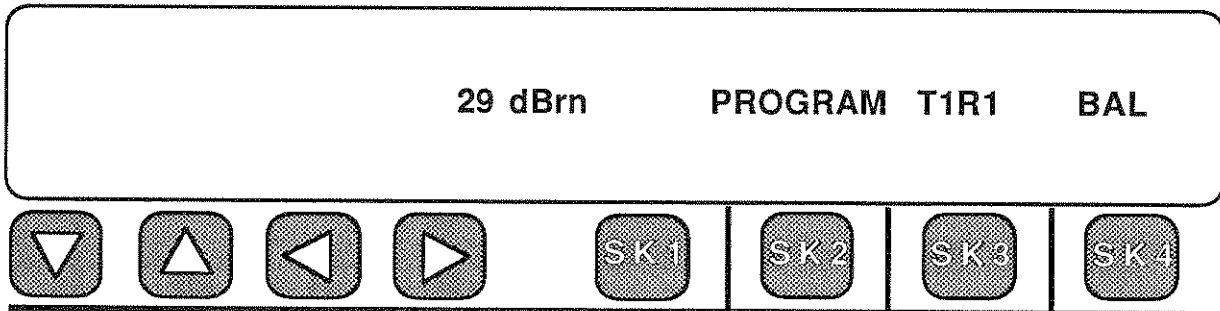

This is a measurement of **PROGRAM** weighted noise in dBrn at the T1R1 interface in Balanced mode. This is a Program type circuit that uses frequencies up to **20K Hz**.

If it is required that a higher frequency be tested, pressing (SK2) will toggle the filter setting to **50 K-BIT**. See the display below:

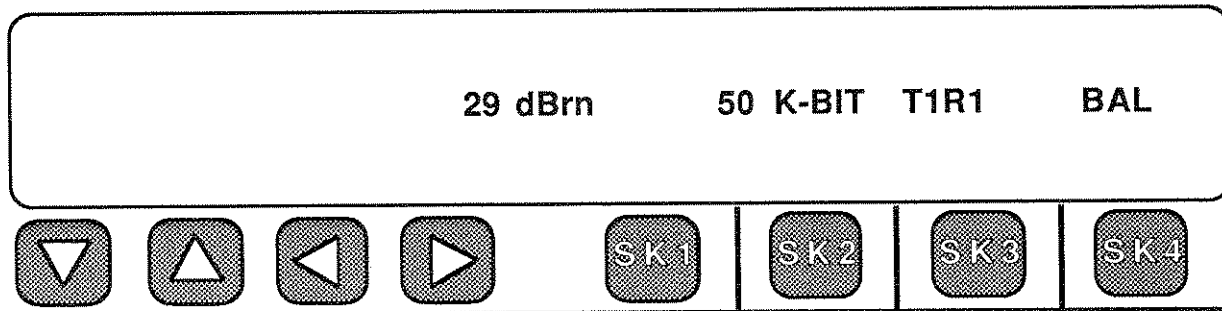

One other Wideband filter is available for Broadband and ISDN facilities. This is the **50K BESSEL** filter. The new DSL and HDSL technologies will require a flat response out to approximately **100K Hz**. This filter will provide this capability.

To toggle between **BALANCED** and **N TO G** when a Noise-to-ground measurement is required press (SK4).

4-4 EXTENDED FEATURES/OPTIONS FUNCTIONALITY

4-4.1 OPTION MENU 10 - FREQUENCY SWEEP

Select **Option Menu 10** and press (SK1). The following screen will display:

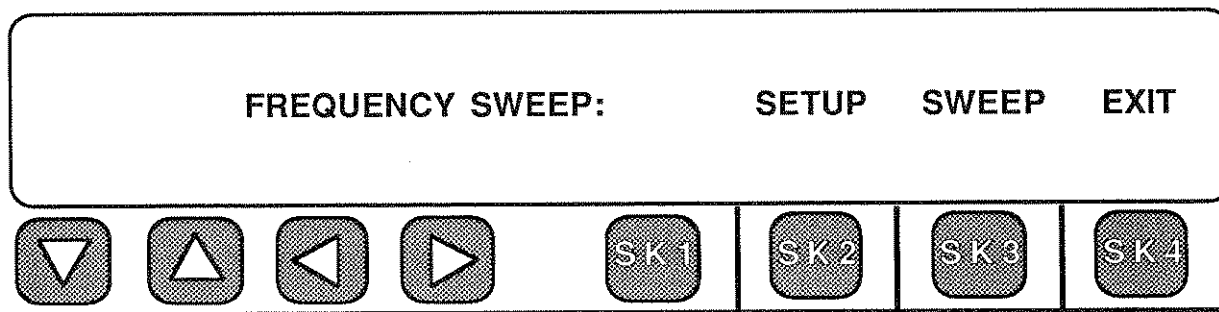

Press **SETUP** (SK2) to setup the defaulted parameters of the Wideband frequency sweep. The following is displayed on the following page:

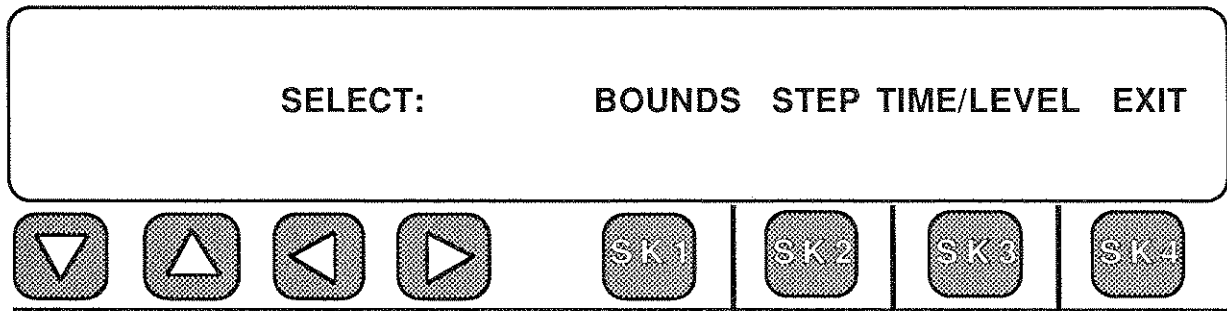

The 930A retains any previous setups. **BOUNDS** requires a setup because it defaults to voice band frequencies. Additionally, previous setups are stored in this function unless a Cold Boot has previously occurred. Press **BOUNDS SK1**). The following screen is displayed below:

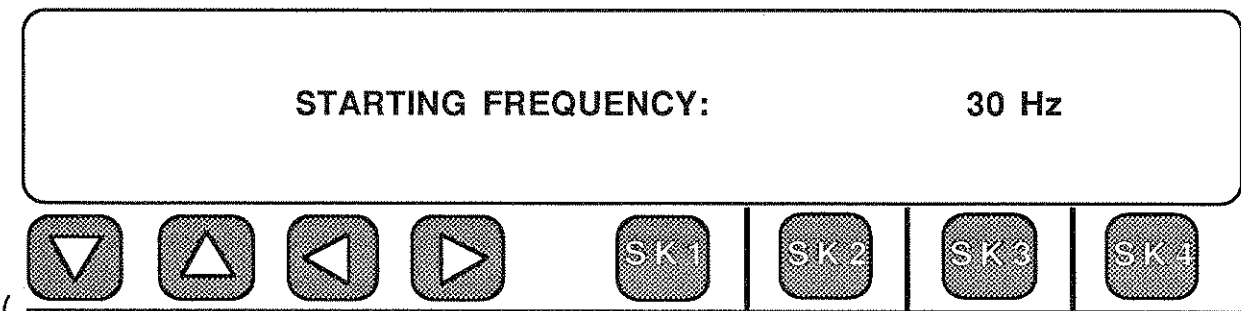

The **STARTING FREQUENCY** for this example is set for **30 Hz**. To change the starting frequency, enter the starting frequency from the Numeric keypad.

Press Enter at the end of the entry. The following screen is displayed:

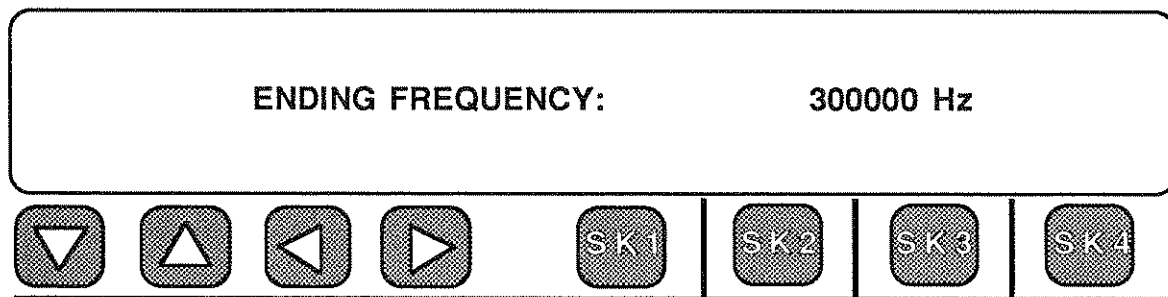

Again, for the example, we are configured for an ending Wideband frequency of **300K Hz**.

If you require a change, press **SK3**, enter the required

frequency by the Numeric keypad and press Enter. The following display will result:

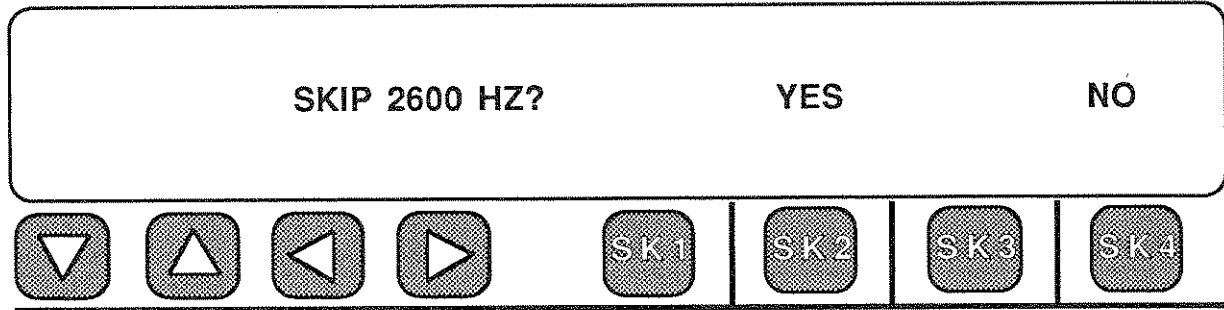

YES is invalid for normal Wideband testing. Select **NO** by pressing (SK4). The following screen is displayed:

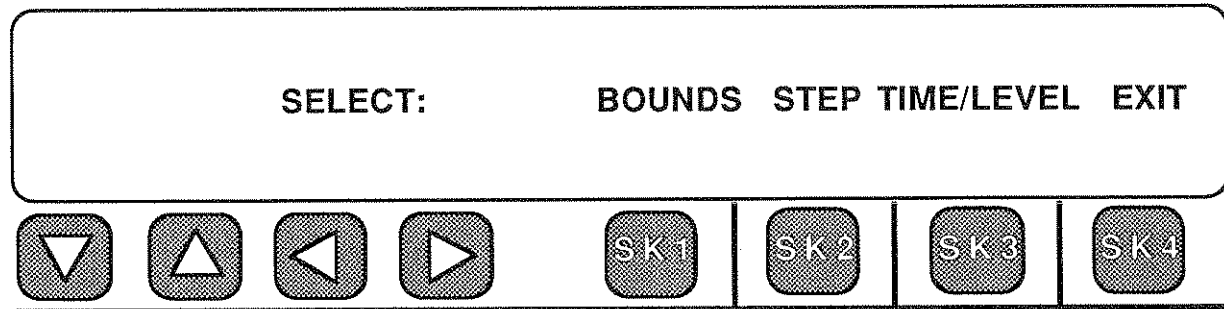

Next, select **STEP TIME**. Since we are testing Wideband, it would be advisable to change the default to greater than **100 Hz**, say **500 Hz**.

The following screen will display:

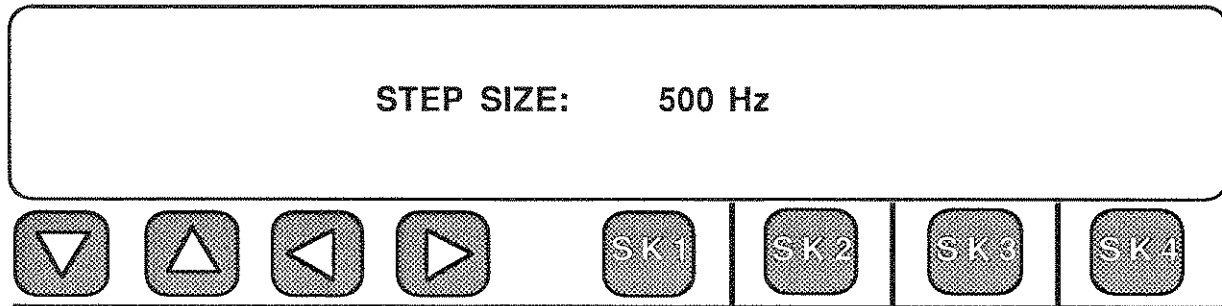

If you require a change, enter the frequency required by using the Numeric keypad, then press Enter. When complete, the screen will again display the following below:

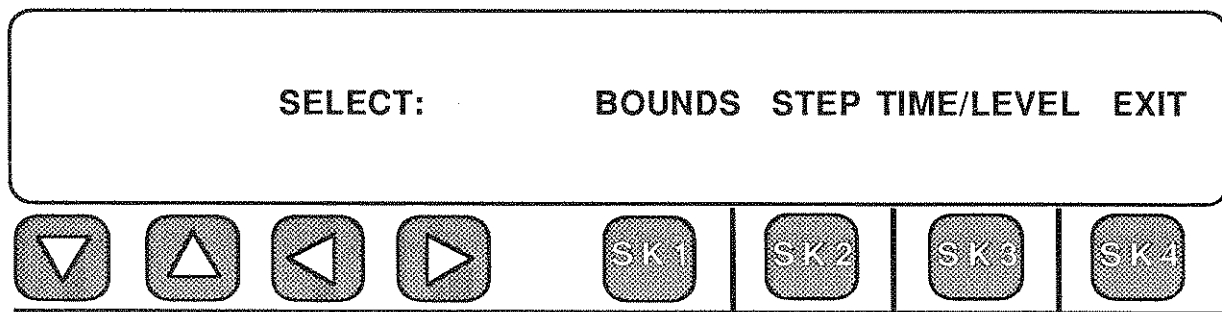

Press (SK3) if time between steps or level requires a change. The following screen will display:

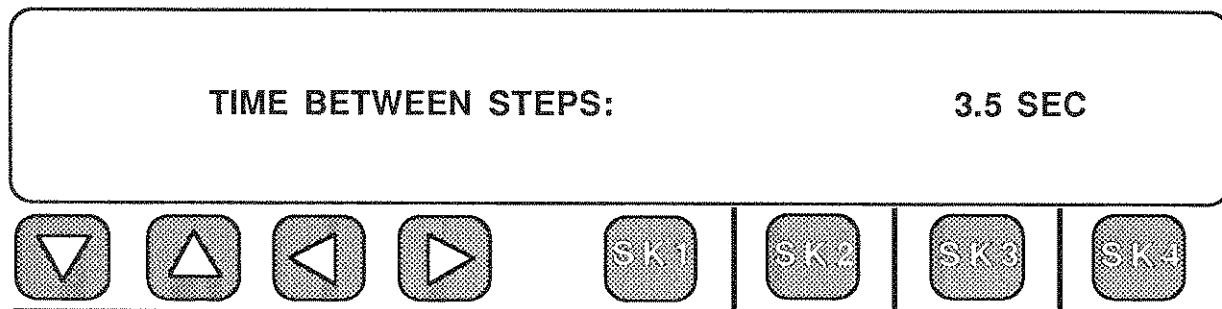

Enter the required time/step change using the Numeric keypad. Press Enter when complete. The following display results below:

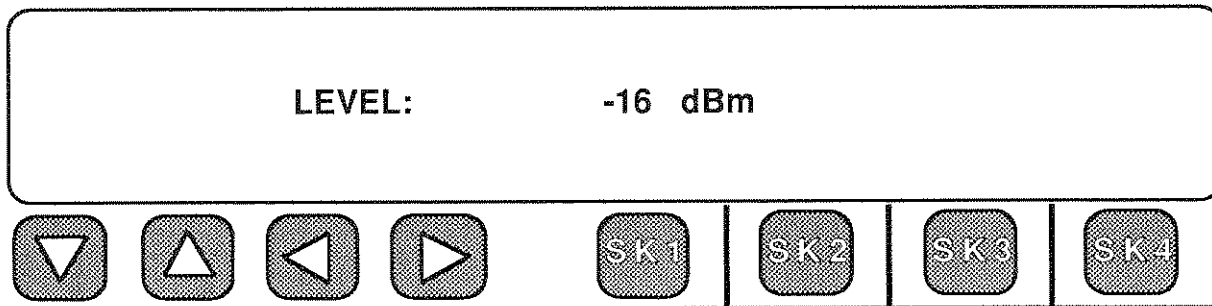

If you require the level to be changed, enter the proper level using the Numeric keypad. Upon completion, press Enter. The screen displays below:

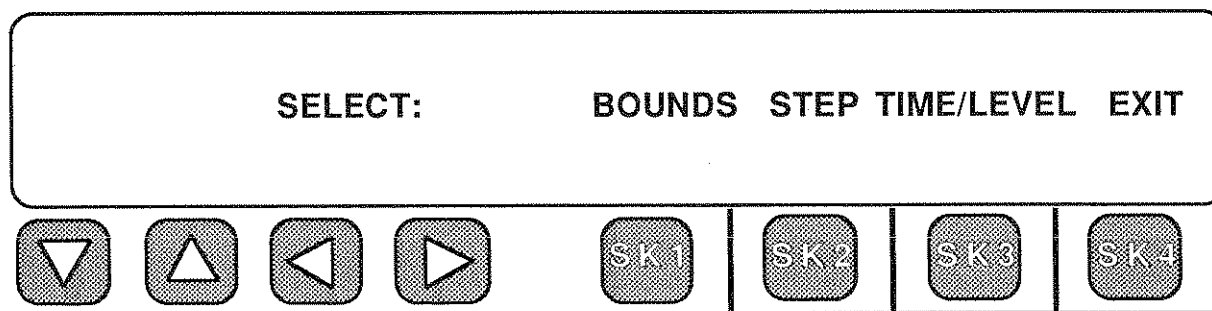

Press Exit after completing the setup for Wideband Sweep. The following screen will display:

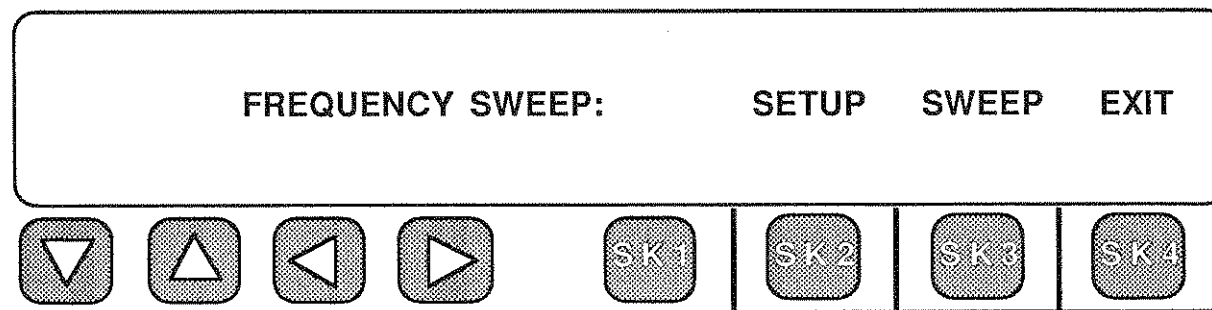

Press **SWEEP** (SK3) to enter the **SWEEP** mode. The following screen is displayed:

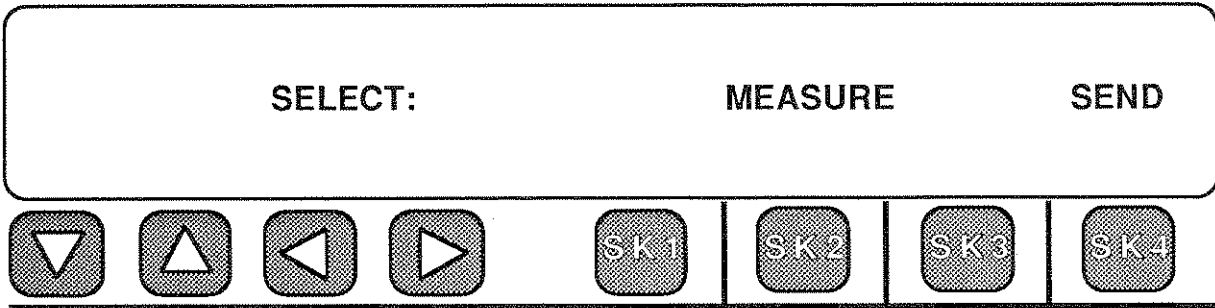

The two choices are Measure and Send. If you require a send only situation, press **SEND** (SK4). You will hear the audible frequency in the speaker. If you require a measurement, press **MEASURE** (SK2) and you will display the measured frequency as you sweep on the transmit.

The following screen is displayed on next page:

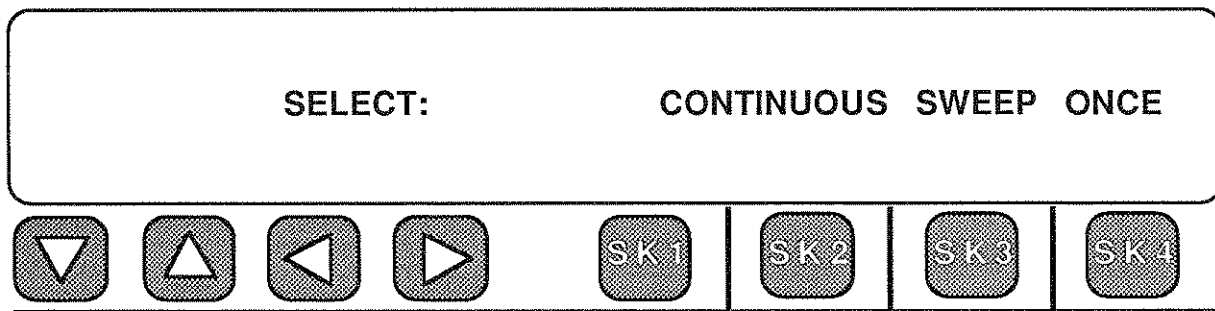

For continuous sweep, press **CONTINUOUS** (SK2). To Sweep only once, press (SK4) once. You will immediately hear the Sweep tone, and will measure the received frequency as the sweep continues. (Note: When you have reached the frequency of approx **3500** Hz, you will no longer hear the audible tone in the speaker.) If you press **SWEEP** (SK3) instead of (SK2) or (SK4), sweep will start at the default or last known setting.

The following measurement screen will be displayed:

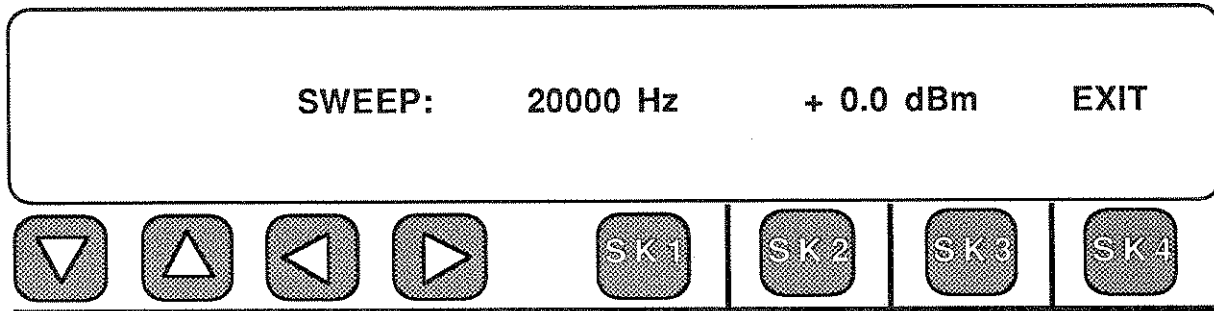

In the **MEASURE** mode, this is the received level and frequency. The 930A will display the outgoing frequency and level if it is not in the **MEASURE** mode.

4-4.2 OPTION MENU 11 - IMPULSE NOISE AND HITS

Enter Option Menu 11. The following screen is displayed:

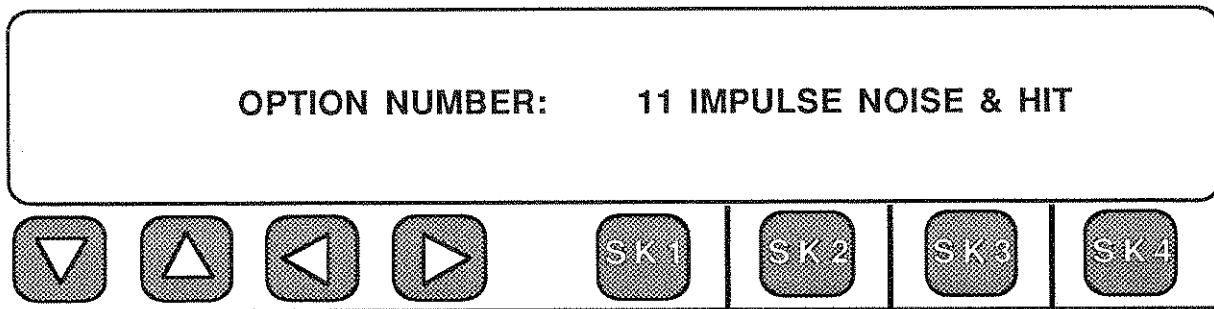

Press the (SK1) softkey. The following screen is displayed:

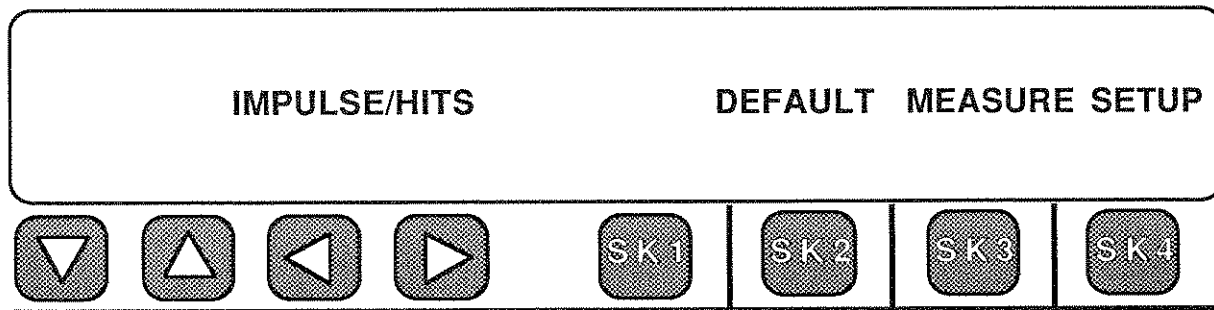

Press **DEFAULT** (SK2) key if you require **DEFAULT** thresholds. The following screen is displayed momentarily:

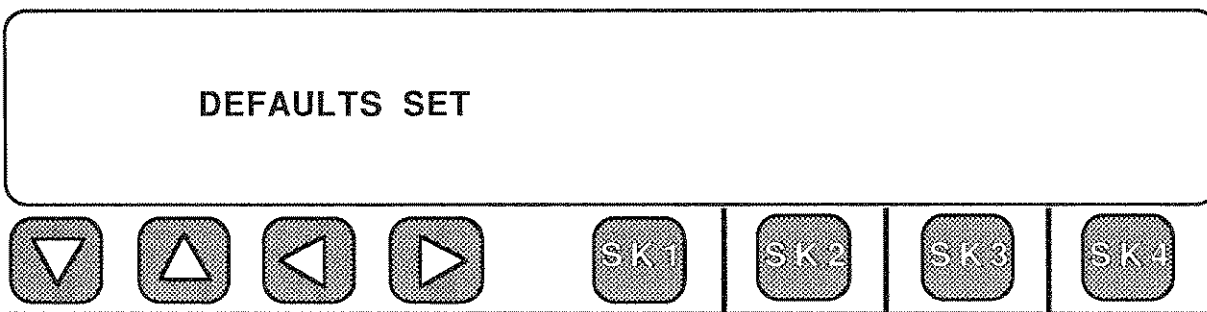

If a new **SETUP** is required, press **SETUP** (SK4) as above. The following screen is displayed:

To change any of the setup parameters, press the appropriate Softkey. For instance, to change the noise threshold, press (SK1). The following screen is displayed:

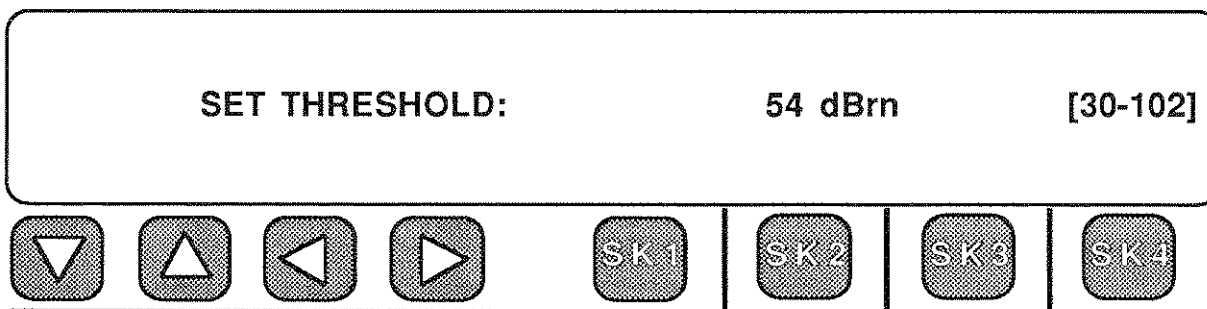

Enter the required threshold using the Numeric keypad. Use the range from above (SK4). After pressing the enter key on the keypad, the following screen is displayed:

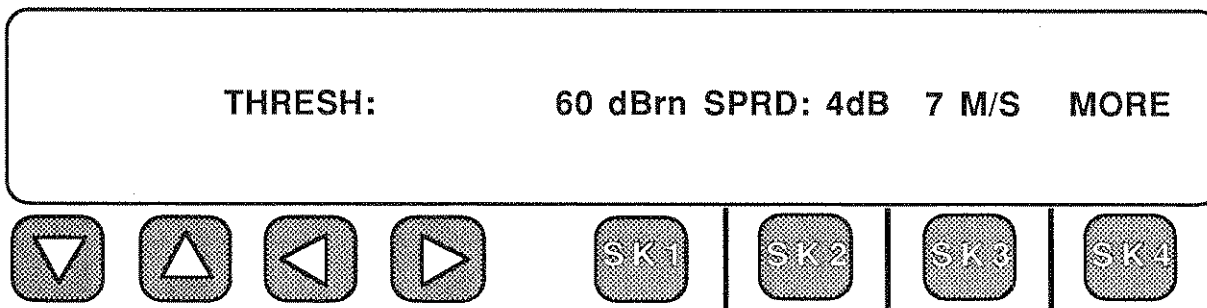

In Wideband, there is no capability to press **MORE** (SK4) and setup thresholds for Phase hits and Gain hits. The settings remain blank. If you want to change the spread or Sample rate, press (SK2) or (SK3) respectively. Enter the required parameter using the Numeric keypad. If you press **MORE** another time, filter selection will be available. The following screen is displayed:

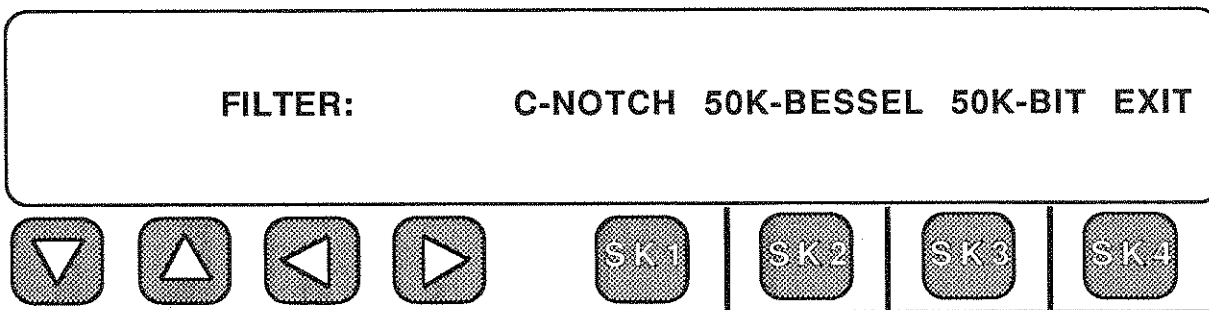

Press **50K-BESSEL** (SK2) or **50K-BIT** (SK3) as required. You will see the following screen below:

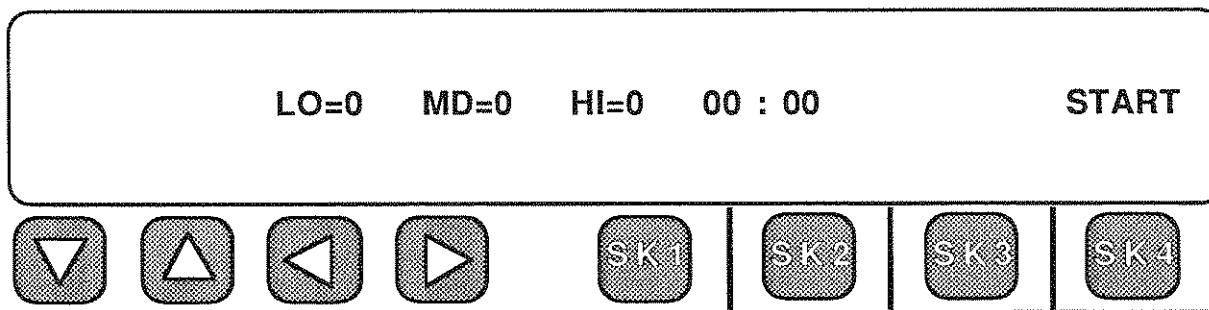

Press (SK4) when you are ready to start test. In Wideband, it is not required that any tone be received in order to measure Impulse noise.

The following screen is displayed:

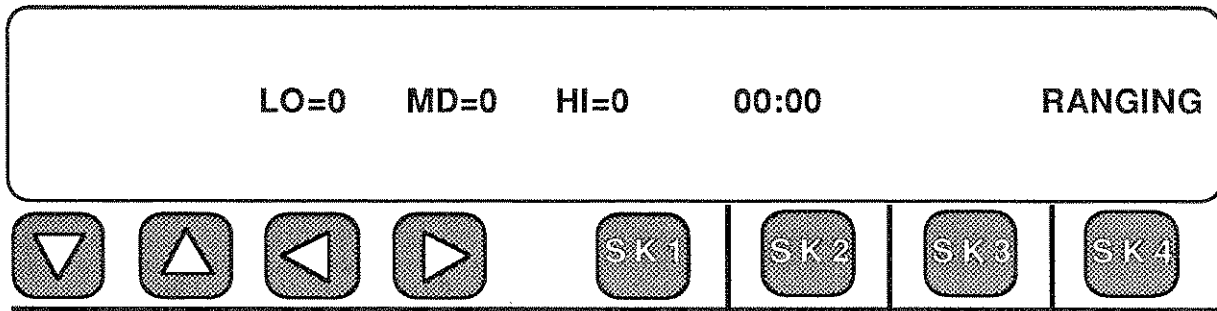

This screen is only momentary and is replaced by the measurement screen below:

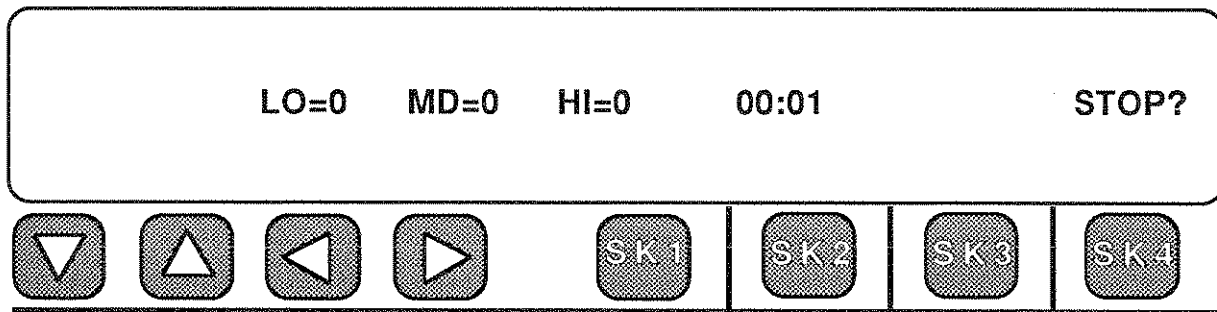

If you need to **stop** the test, press **STOP** (SK4). Otherwise the test will accumulate Impulse noise for the duration of the test.

If you did not need to change the setup above and pressed **DEFAULT** instead, the parameters were defaulted. Press **MEASURE** (SK3). The following screen is displayed below:

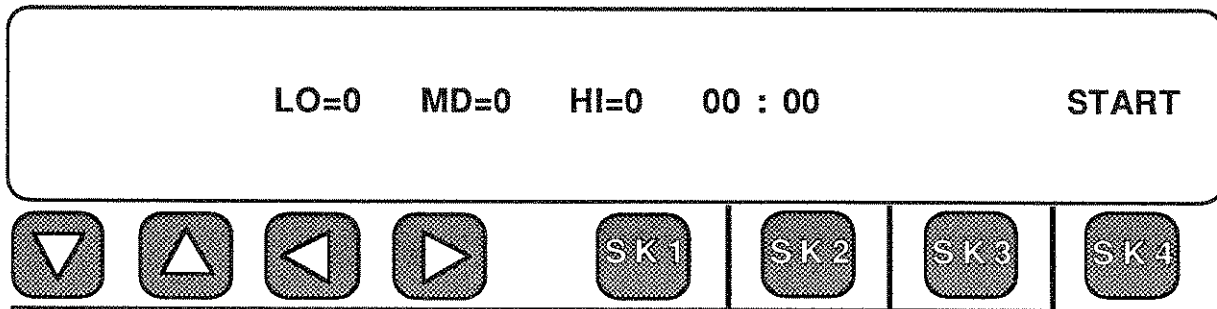

As above, when you are ready to start testing, press **START**(SK4). The test will display **RANGING** and will display the measurement screen as above. **NOTE:** The **50K BESSEL** filter is defaulted as the active filter unless you change the setup.

If you are doing a voice band Impulse Noise test, you should change the Trunk Type to 4W E&M Type 1 600 ohms or select Option Menu 95, Dry Loop, 600 Ohms and Enable. The present Software will **not** allow you to do a Impulse Noise test in 600 Ohms Bridging. The following screen will be displayed:

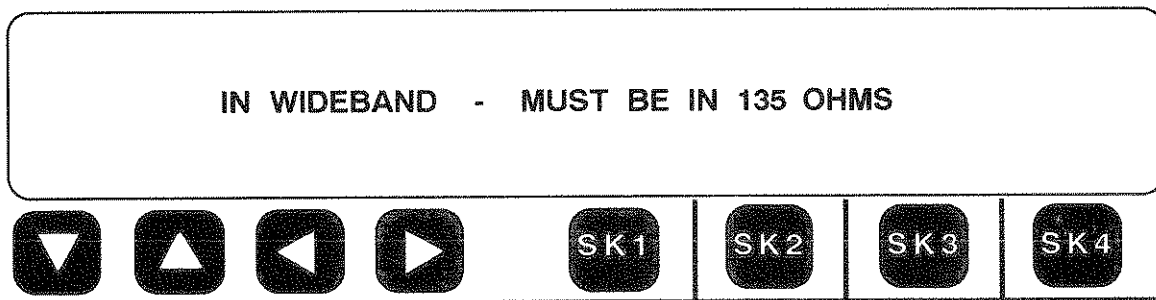

To change the Trunk Type to 135 Ohms, press Trunk Type. Select **WIDEBAND** from the Trunk type Menu. The following screen is displayed below:

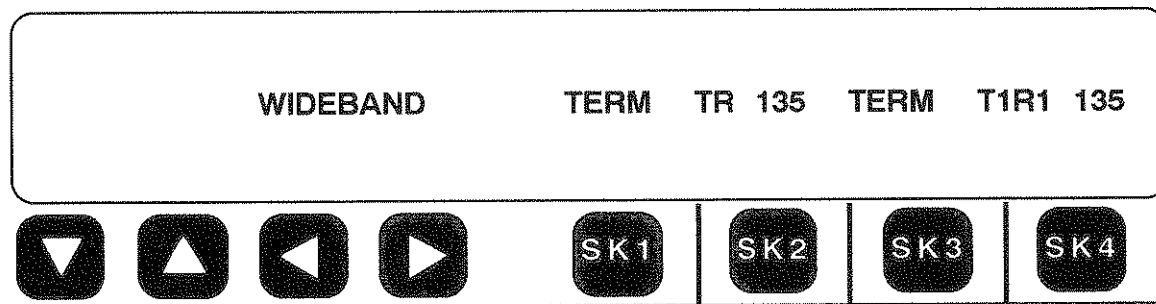

Change the the Termination impedences to 135 Ohms by pressing **TR** (SK2) or **T1R1** (SK4) and scrolling through the selections until **135** has been selected.

This page intentionally left blank.

SECTION IV BASIC T-1 PCM OPERATION

4-1 THE T-1 PCM TRUNK TYPE INTERFACE (OPTION 930A-08E OR -09E)

This section of the manual describes the operation of the 930A when Option 930A-08E (**Single Direction PCM**) or Option 930A-09E (**Dual Direction Drop and Insert**) has been installed in the 930A. **NOTE:** If Option 930A-17 (no analog interface) has been ordered, there are no other Trunk Type selections available **except PCM**.

Either Option 930A-08E, or -09E, has the capability to operate on the normal **D4 Superframe** format T1 carrier, as well as the **SLC-96** system and the Extended Superframe (**ESF**) format. The 930A will detect whether the T-Carrier is a **D4 Superframe** or **ESF** formatted signal, and set itself automatically when first plugged into the span at the **DSX**. **It does not** set itself for **SLC-96**, so you will have to select **SLC-96** framing **manually** to work on a **SLC-96** span. **Once you have selected SLC-96 framing**, the 930A operates exactly the same as it does on any other T1. The examples which follow are useful in any framing format.

The 930A comes from the factory with the most commonly used settings as its defaults so it is not normally necessary for you to change anything in the set-up menu. All you have to do is turn it on and plug it into the **DSX** jacks to begin testing.

The factory DS-1 (T1) defaults are:

| | |
|-----------------------------|--------------------------|
| Impedance: | 100 ohms |
| Framing: | D4 Superframe |
| Signaling: | Robbed-Bit |
| Line Coding: | Alternate Mark Inversion |
| Channel Numbering Sequence: | D3/D4 |
| Supervision: | Normal (E&M) |

When you first turn on the 930A it could be in any Trunk Type because it remembers the last trunk it was set to when it was turned off. **The first thing you do after you turn on the 930A is select the PCM Trunk Type.**

To select **T1 (DS-1) PCM** Trunk Type:

1. Press the **TRUNK TYPE** function key.
2. Use the **UP/DOWN** arrow keys or Softkey 1 to select the display entitled "**OPTIONAL TYPES**".
3. Press Softkey 2 (under **PCM**).
4. Refer to Section 4-1.1 for operating details in **PCM**.

To select the **PCM** Trunk Type, press the following keys on the 930A:

Press the Trunk Type  **Trunk Type** function key

to display the currently selected Trunk Type.

Use the UP/DOWN   arrow keys to

page through the available displays until you see the following display appear:

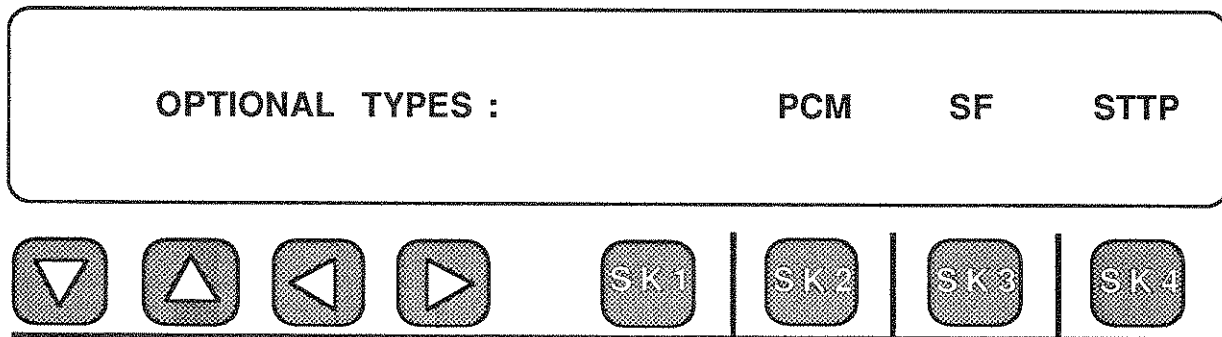

Press Softkey 2 (under **PCM**) and the 930A will show you the **PCM** Trunk Type display. This display returns to the last settings you had entered. The display below shows the factory default **PCM** display:

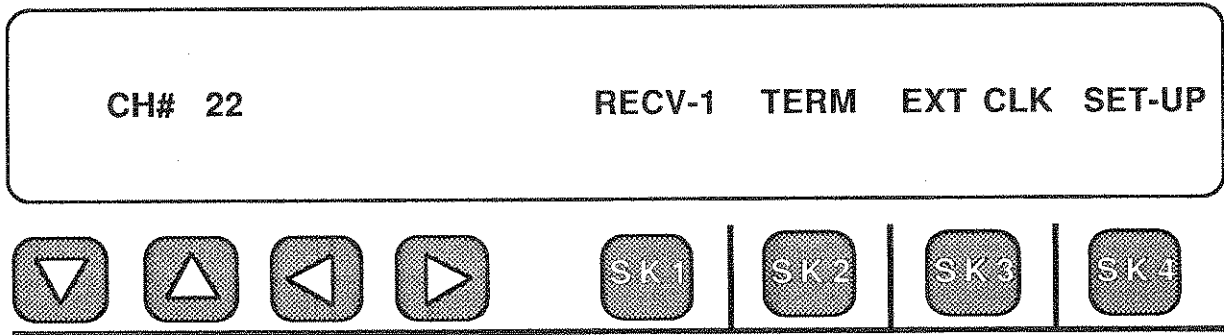

4-1.1 HOW TO CHANGE PCM CHANNELS AND TEST DIRECTION

Start from the main PCM default display. An example is shown below:

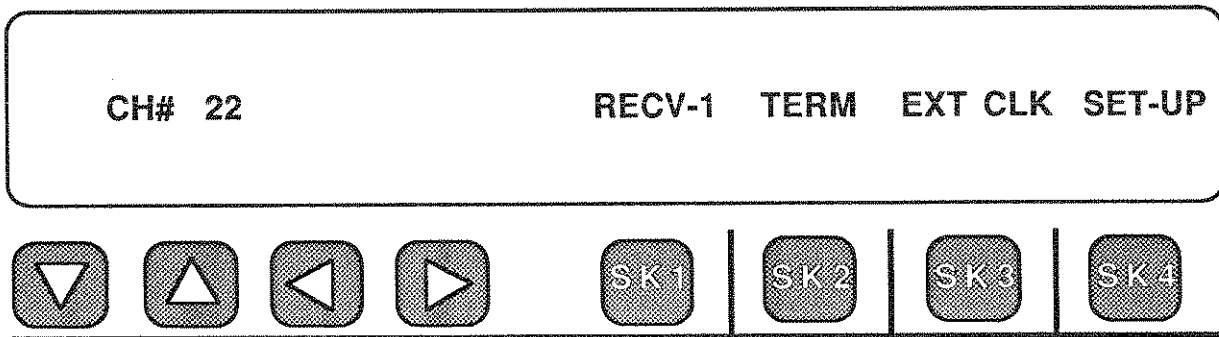

TO CHANGE PCM CHANNELS, use the **UP/DOWN** Arrow keys just as you do with a TV remote control, or enter the number of the channel (1 to 24) from the Numeric keypad, and press the **ENTER** key.

TO SELECT TEST DIRECTION, press Softkey 1 (under **RECV-1**). This key is only active if you are in the **MON-1&2** or **D&I** mode. It toggles between side 1 and side 2, and vice versa, without having to swap test cords around. If you are in **TERMINATE** or **MON-1**, the key is inactive because only side 1 is receiving.

Option 930A-08E gives you only **TERMINATE** and **MON-1** modes. To have the capability of looking in both directions, you must have **Option 930A-09E** in your 930A. **Option 930A-09E** gives you the additional **MON-1&2** and **D&I** modes. It has two transmitters and two receivers.

TO SELECT THE SPAN TEST MODE, press Softkey 2 (under **TERM** in the default display above). This brings up your other choices. Press the softkey directly under the mode you want in the display shown below:

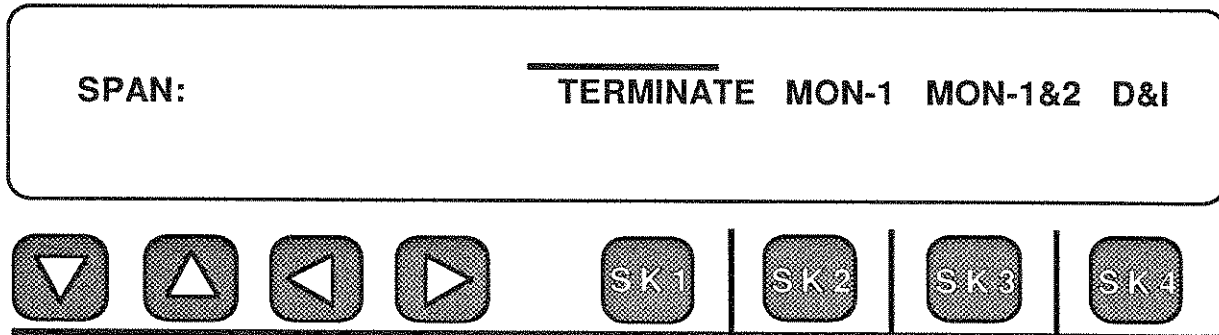

In **TERMINATE** mode, the 930A acts as a channel bank terminating one end of the span. **MON-1** is used for monitoring one direction of transmission while **MON-1&2** is used to monitor traffic in both directions simultaneously by activating both of the 930A's receivers. The **D&I**, or Drop and Insert, mode is used on live spans between two switches or multiplexers, etc. One of the 24 channels is dropped out for testing while the other 23 pass through undisturbed.

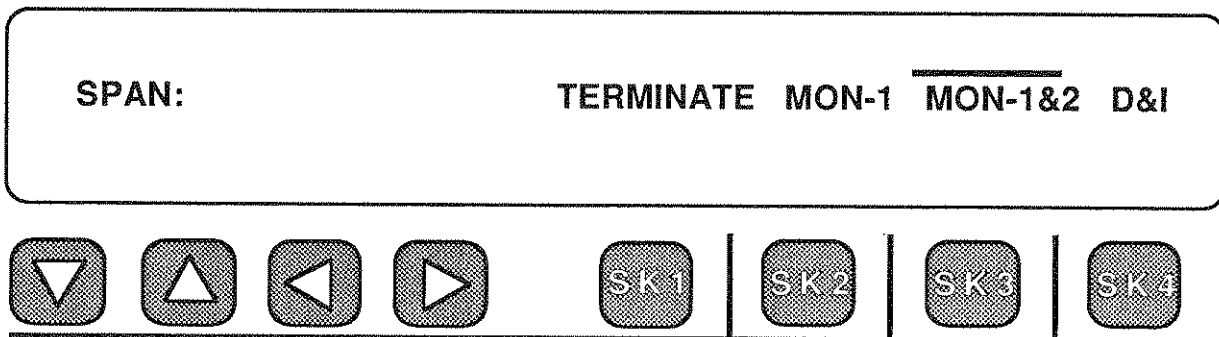

If the 930A is in either **MON-1&2** or **D&I** mode, and you select **TERMINATE** or **MON-1** mode, you will be prompted with the screen:

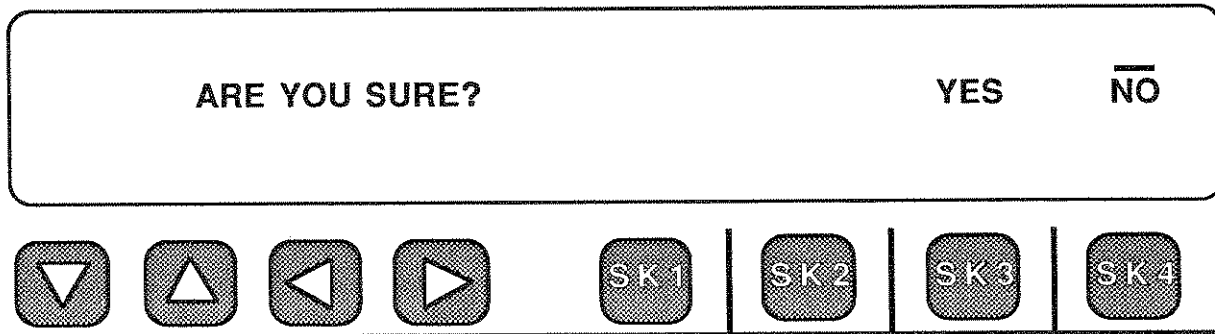

This prevents you from accidentally dropping a live span by choosing **TERMINATE** or **MON-1**. It does not prevent you from doing so intentionally. After you choose a test mode, the 930A will return to the main menu and show the change.

To Terminate the span, press Softkey 1 (under **TERMINATE**). The 930A display would change to:

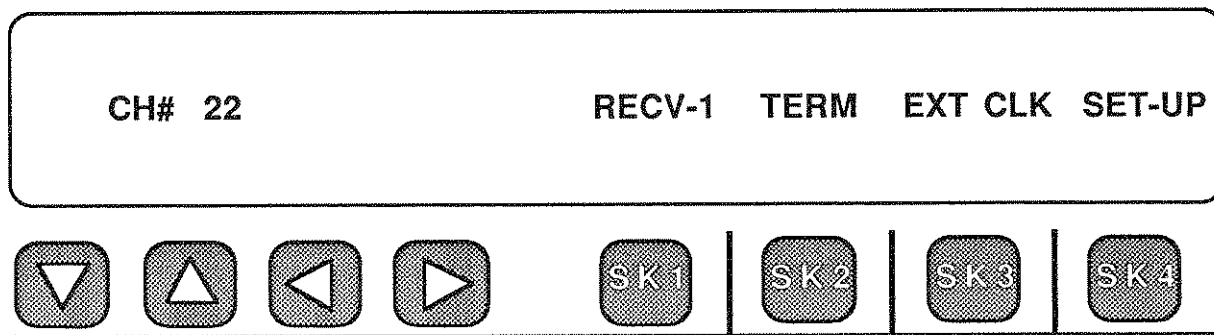

You normally want to be **LOOP TIMED** to the span (**EXT CLK** to the 930A). There are times when you may want to supply clock from the 930A. Then you select **Internal Clock**.

TO SELECT THE CLOCK SOURCE, press Softkey 3 (under **EXT CLK**) and the **CLOCK** display will come up.

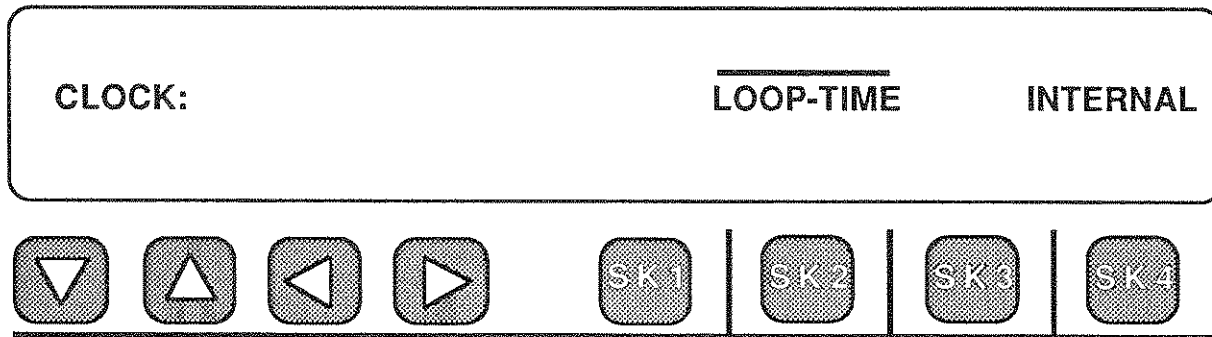

The cursor appears over the previous selection (**LOOP-TIME**). To supply clock, press Softkey 4 (under **INTERNAL**) and the 930A display will become:

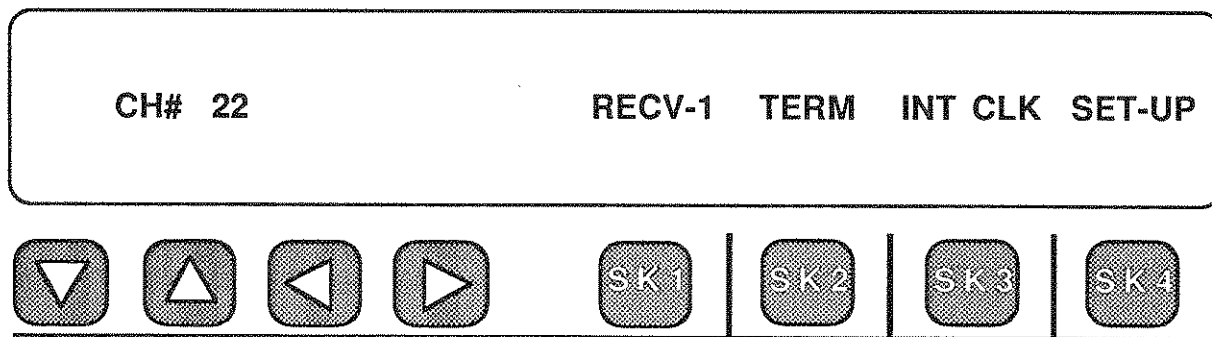

Internal Clock is only available in the **TERMINATE** mode. The 930A will not insert its clock into a span in the **DROP & INSERT** or **MON-1&2** modes.

In the **TERMINATE** mode, it is assumed that the T1 span you are terminating has been taken out of service for test purposes. With the other three modes it is assumed that live traffic may be on the span.

4-1.2 HOW TO CHANGE THE PCM DEFAULT SETTINGS

You do not usually need to change the defaults, but you may want to manually select Extended Superframe, **SLC-96**, or some other parameter. This is where the **SET-UP** menu comes in handy.

TO CHANGE THE DEFAULT SET-Ups, or the set-up you have previously entered, press Softkey 4 (under **SET-UP** above). This will start paging you through the settings. **The cursor appears** above the current selection. You can go directly to the setting you want by pressing the **UP** or **DOWN** Arrow keys, once you are inside the **SET-UP** menu.

TO CHECK THE IMPEDANCE, you get the following display first:

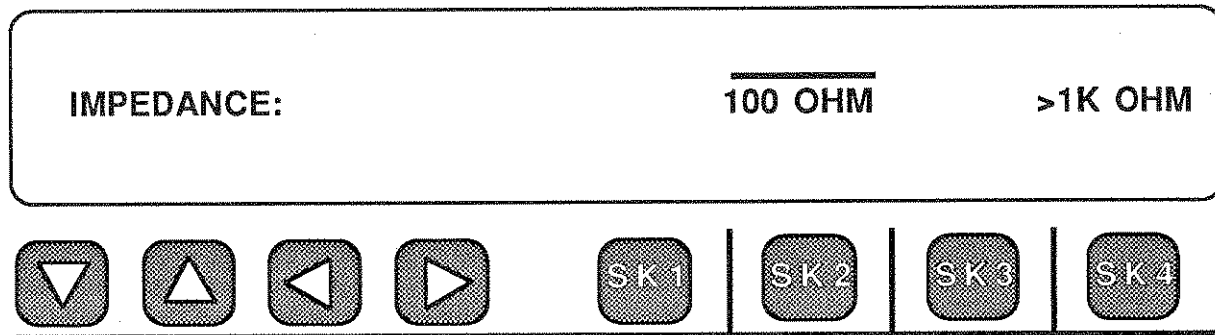

You should always use the **100 OHM** default at the **DSX** jacks

(including the Monitor jacks) or at the CSU or Office Repeater jacks. **Use >1K OHMS only** in cases where your **DSX does not** supply isolation resistors. Press Softkey 2 (under **100 OHM**) to advance to the next choice.

The **>1K OHM** selection is **not** a normal choice. If you should encounter a problem with false errors or frame loss indications on your 930A, please check to see that someone else has not left your 930A in the **>1K OHM** position. If you leave the 930A in the **>1K OHM** position and connect it to the **DSX Monitor jacks** (which already have 1000 ohms of isolation), the signal will be distorted and cause error indications.

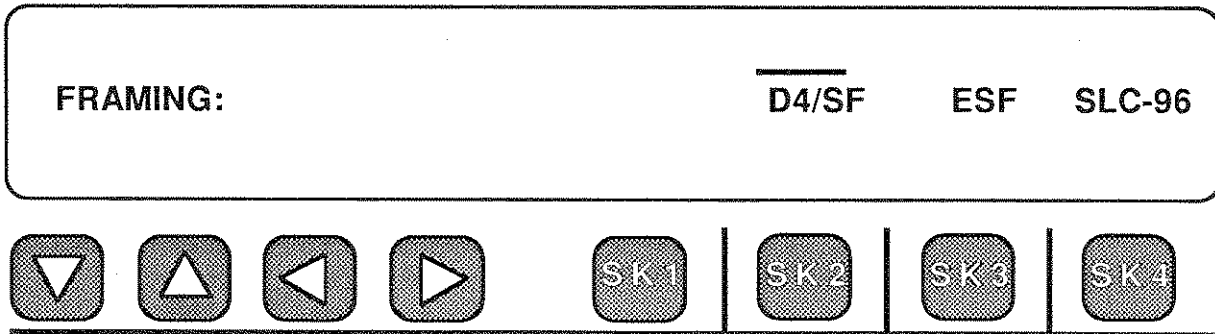

TO CHANGE THE FRAMING FORMAT, you will need to know what kind of span you are on, unless you want the 930A to choose for you.

TO CHANGE SIGNALING TYPE, press the softkey under your choice.

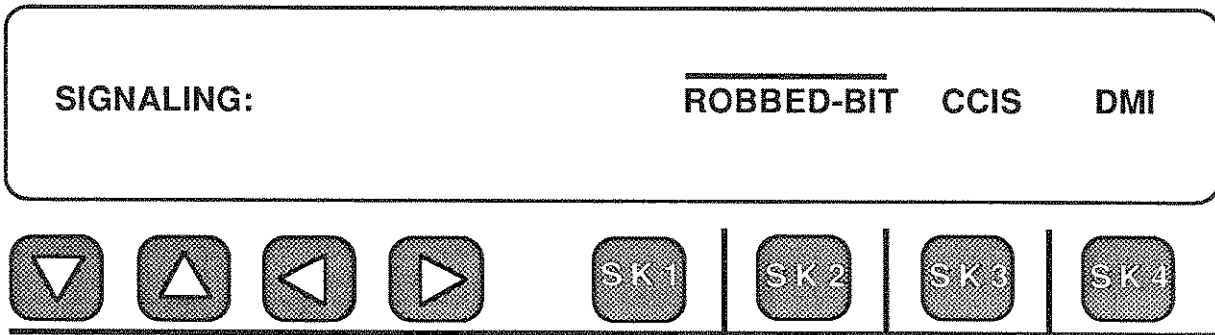

ROBBED-BIT signaling is the most common form of T-Carrier signaling today. **CCIS** is found on AT&T Toll switches. New switches using **SS7** signaling would also use this format. All 8 data bits are used per channel. All signaling occurs over a separate path from the "talk" path. **Digital Multiplex Interface (DMI)** is a future option for the 930A. The 930A will advance to **LINE CODING** after you make your choice.

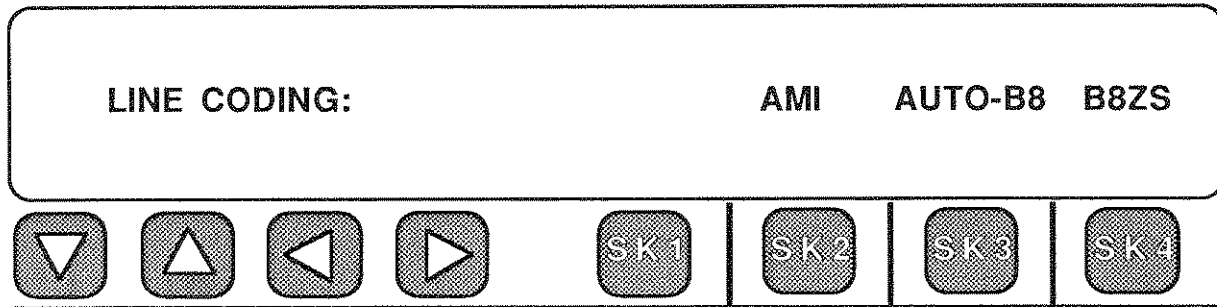

TO CHANGE THE LINE CODE, you must know what is on the T1 span. . Choose Alternate Mark Inversion (**AMI**) by pressing Softkey 2 and the 930A will go to the **CHANNEL SEQUENCE** display. To change to Auto B8ZS, select SK3. **Note:** Auto B8ZS will allow automatic selection of B8ZS if that pattern is received and **AUTO-B8** is selected.

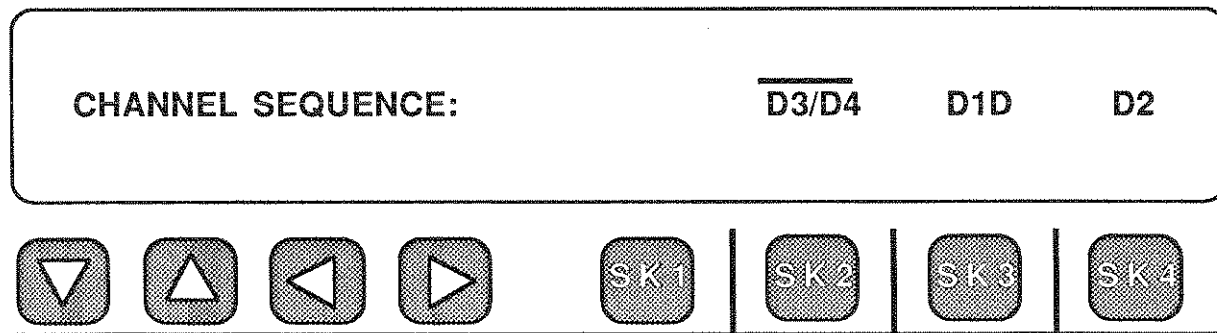

TO CHANGE THE CHANNEL NUMBERING SEQUENCE, press the softkey under what you want. All modern channel banks of the mid-1970s vintage, and up, are **D3/D4** sequential format. You can safely leave the default alone in 99.9% of the cases. After making your selection, the 930A will advance to the last default selection which is **SUPERVISION**.

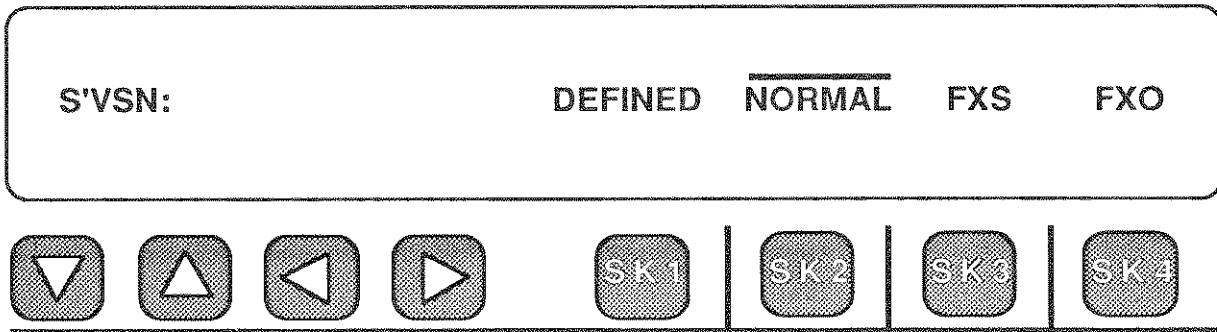

TO CHANGE THE SUPERVISION TYPE, you should know the type of supervision on your T-Carrier span.

The default is **NORMAL** and is equal to **E&M** signaling on digital switches. An **ON HOOK** is signalled by the A and B (or A, B, C and D) bits being in a 0 state. An **OFF HOOK**, or busy, is given by these bits going to a 1 state. Option 930A-25 can simulate the Office end or Station end of a **Foreign Exchange** circuit (**FXO** or **FXS**). **DEFINED** mode lets you define the **ON** and **OFF HOOK** states to be any combination of A and B (or A, B, C and D) bits.

Note: If you change the Defined mode to other than A=B using DP, verify that the significant bit is also defined in Dial/Ring. See display below.

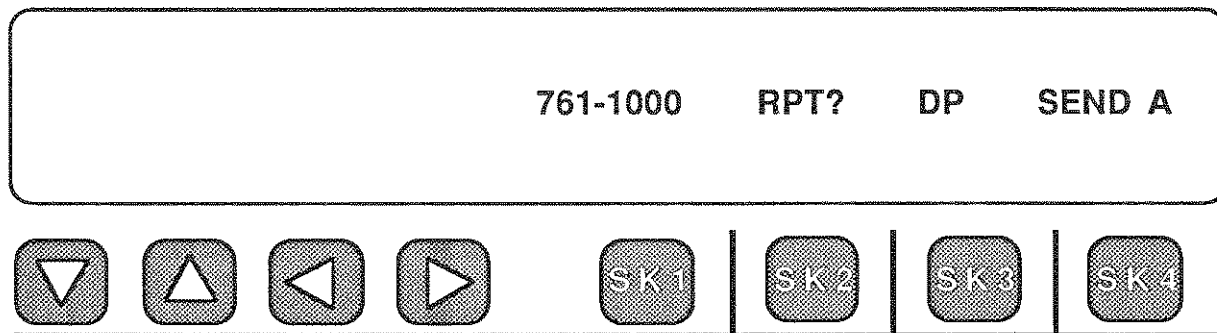

NOTE: The default for each **PCM** parameter is always chosen by pressing Softkey 2 when you are in the **SET-UP** menus. You can use the **UP/DOWN** Arrow keys to page through menus you are not going to change.

When you have made the final selection, the 930A returns to the main **PCM** display.

The 930A remembers all of its settings when you turn it off so it will always come up running with the new default settings you have entered. You need not go to the **SET-UP** menus again unless you want to change something or unless you "Cold-Boot" the 930A which restores the factory defaults.

4-2 HOW TO MONITOR A T1 SPAN

The most basic T1 test you can make is to monitor the span in one direction. The test cord connection to the **DSX Monitor jack** is shown in Figure 4-1 below:

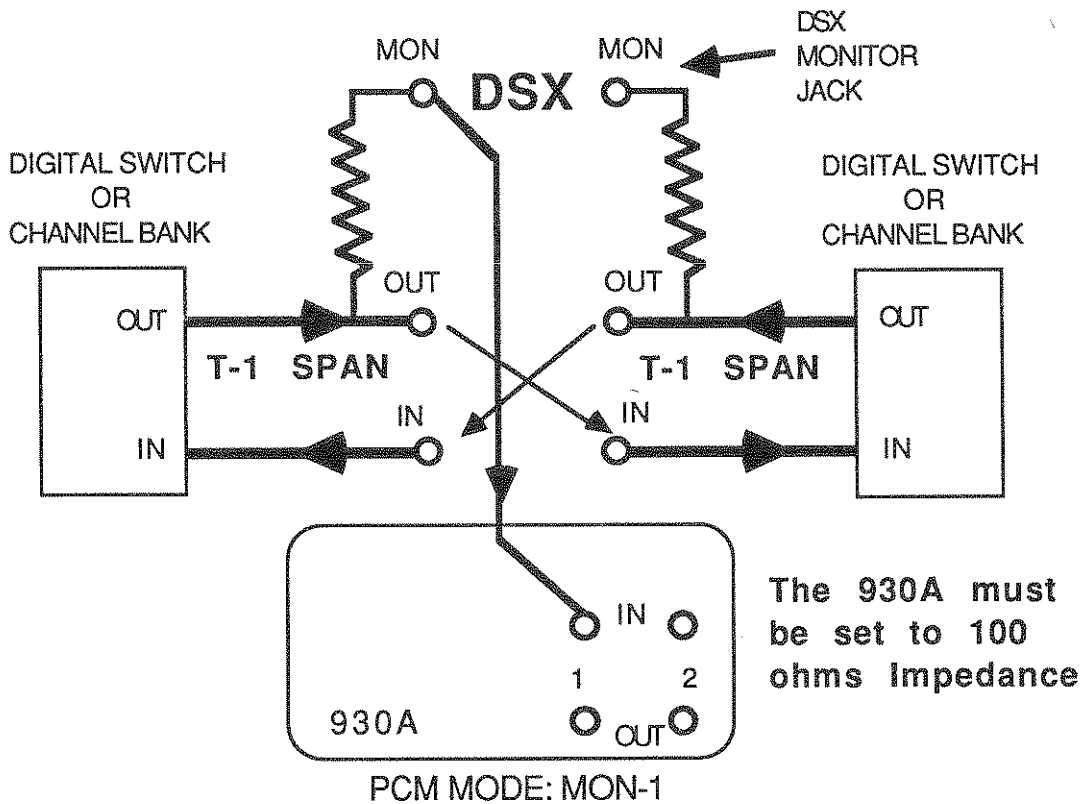

MONITORING ONE DIRECTION ON A T1
FIGURE 4-1

All you have to do is connect the 930A's receiver (**PCM IN 1**) to the **DSX Monitor jack** with a test cord and place the 930A in the **MON-1** mode. The 930A display will look like the one below when it is set correctly.

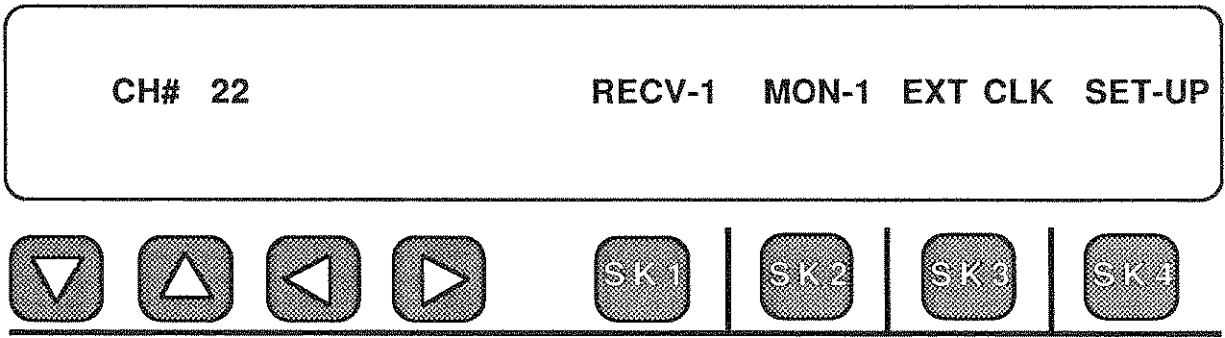

A good question to ask here would be, "What can I test with this?" Well, you can measure anything, such as levels and frequencies or noise. You can't do anything active like placing a call or sending a tone or measuring return loss. You could receive and analyze the digits of incoming calls if you have purchased Option 930A-01. You could move the test cord to the other monitor jack and capture the digits of the outgoing calls. You could measure the wink timing. You could listen to the traffic on the speaker. You could see the status of the A and B bits on all 24 channels. You could count BPVs, frame slips, frame errors, frame losses and CRC errors (ESF). You could measure the T1 voltage at the DSX Monitor level.

Besides MEASURE TONE and MEASURE NOISE, you will find that the following menus, under the OPTION MENU key, are also useful.

| | | |
|-------------------|--------------------|---------------------|
| Option Number: 4 | DIGITRECEIVER | Option 930A-01 |
| Option Number: 8 | SUPERVISIONMONITOR | Standard |
| Option Number: 9 | WINK TIMING | Standard |
| Option Number: 20 | 24 BIT DISPLAY | Option 930A-08E/09E |
| Option Number: 21 | TOGGLE A/B BITS | Option 930A-08E/09E |
| Option Number: 40 | SENDPCMALARMS | Option 930A-08E/09E |
| Option Number: 41 | READ T1 VOLTAGE | Option 930A-08E/09E |
| Option Number: 42 | T1WANDER | Option 930A-08E/09E |
| Option Number: 43 | T1ERRORCOUNTERS | Option 930A-08E/09E |
| Option Number: 44 | T1ERRORHISTORY | Option 930A-08E/09E |

You will quickly discover that monitoring only one side at a time has its limitations. This is why the 930A has **Option 930A-09E** available. This gives you two receivers (**PCM IN 1** and **PCM IN 2**). Two receivers let you point the finger in the right direction when you have a trouble report.

4-3 HOW TO MONITOR BOTH DIRECTIONS ON A T-1 SPAN

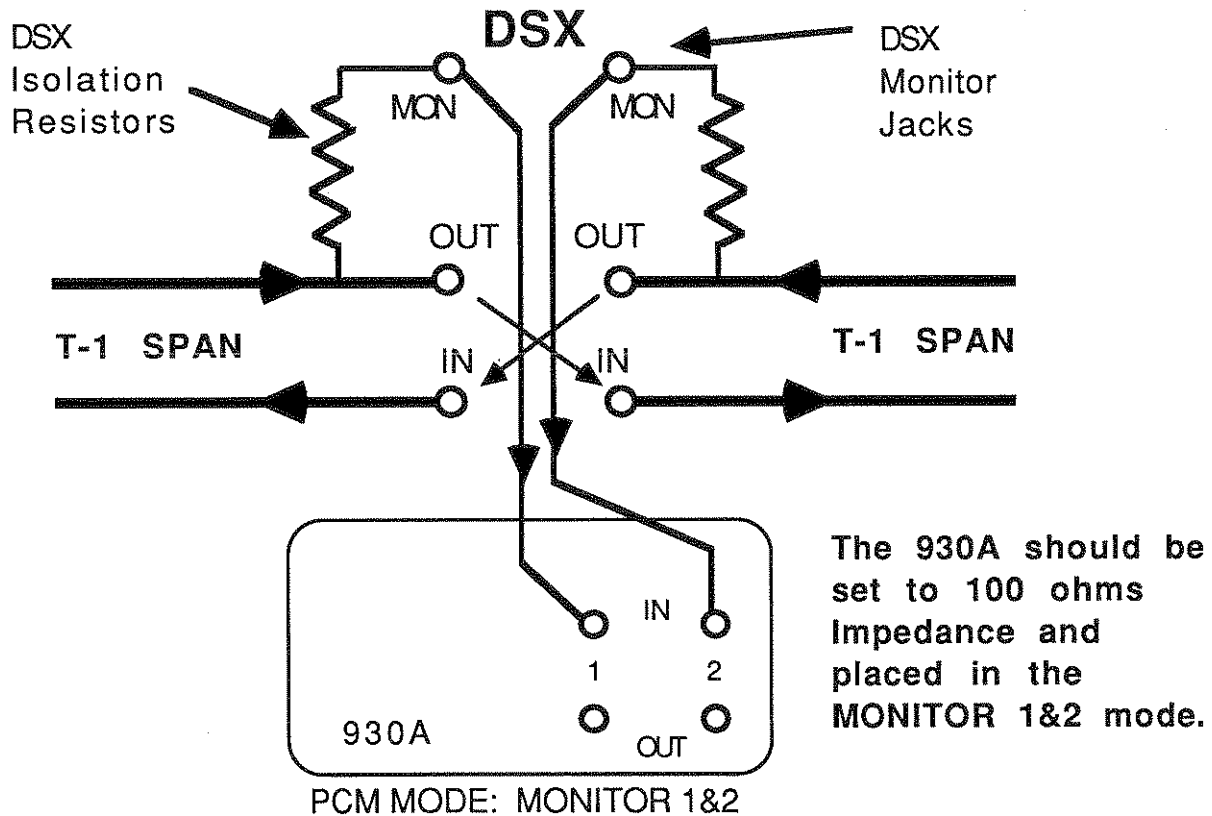

DUAL DIRECTION MONITORING WITH THE 930A
FIGURE 4-2

If you have purchased Option 930A-09E, you can "look both ways" at the same time. From the diagram above, the test cord connections are from the 930A receivers (**PCM IN 1** and **PCM IN 2**) to the **DSX Monitor jacks**. The 930A itself has to be set to the **MON-1&2** mode. The process starts from the default **PCM** display.

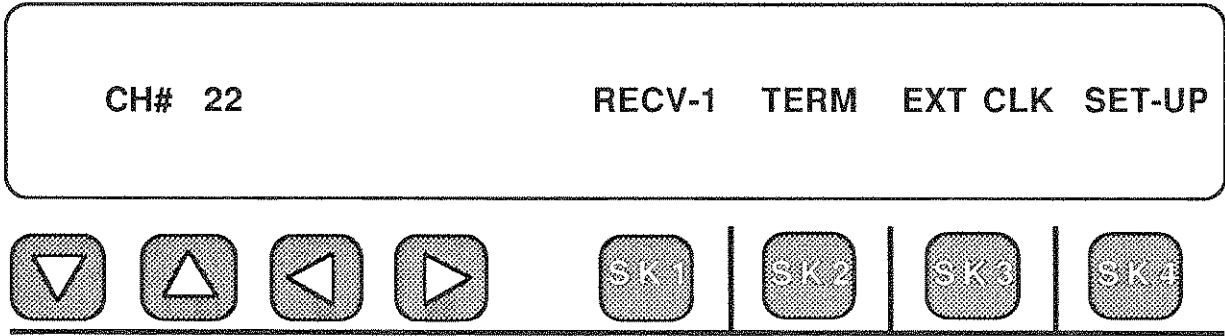

To change the mode of testing, press Softkey 2 (under **TERM**) and your choices will appear as:

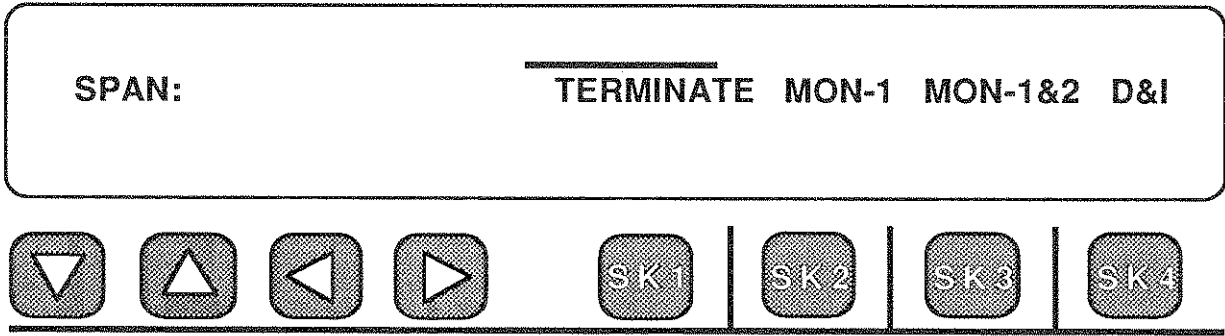

To monitor both sides of the T1 span, press Softkey 3 (under **MON-1&2**) and the 930A does the rest. The main PCM display changes to:

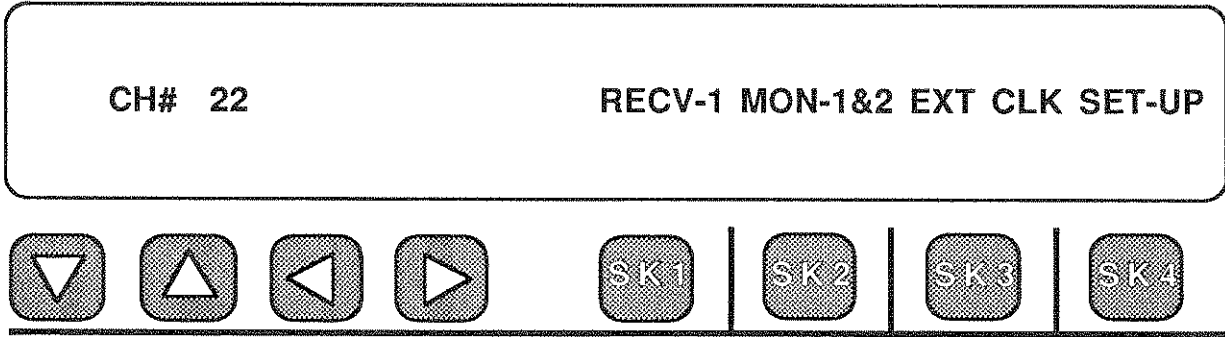

You could be on any channel; channel 22 is only an example. You now have the capability to perform all of the measurements mentioned under single direction monitoring on both sides at once. You can switch between sides by simply pressing Softkey 1 (under **RECV-1**) now instead of moving test cords around. This toggles between **RECV-1** and **RECV-2**.

4-4 TERMINATING A T1 SPAN FOR OUT-OF-SERVICE TESTING

For testing trunks on out-of-service T1 span lines (pre-cutover or turned down for maintenance), the 930A can generate, as well as receive, a DS-1 signal.

Once you have "busied out" the T1 span you are ready to connect the 930A toward the switch, channel bank, etc., you want to test. The test cord connections at a standard **DSX** are shown below:

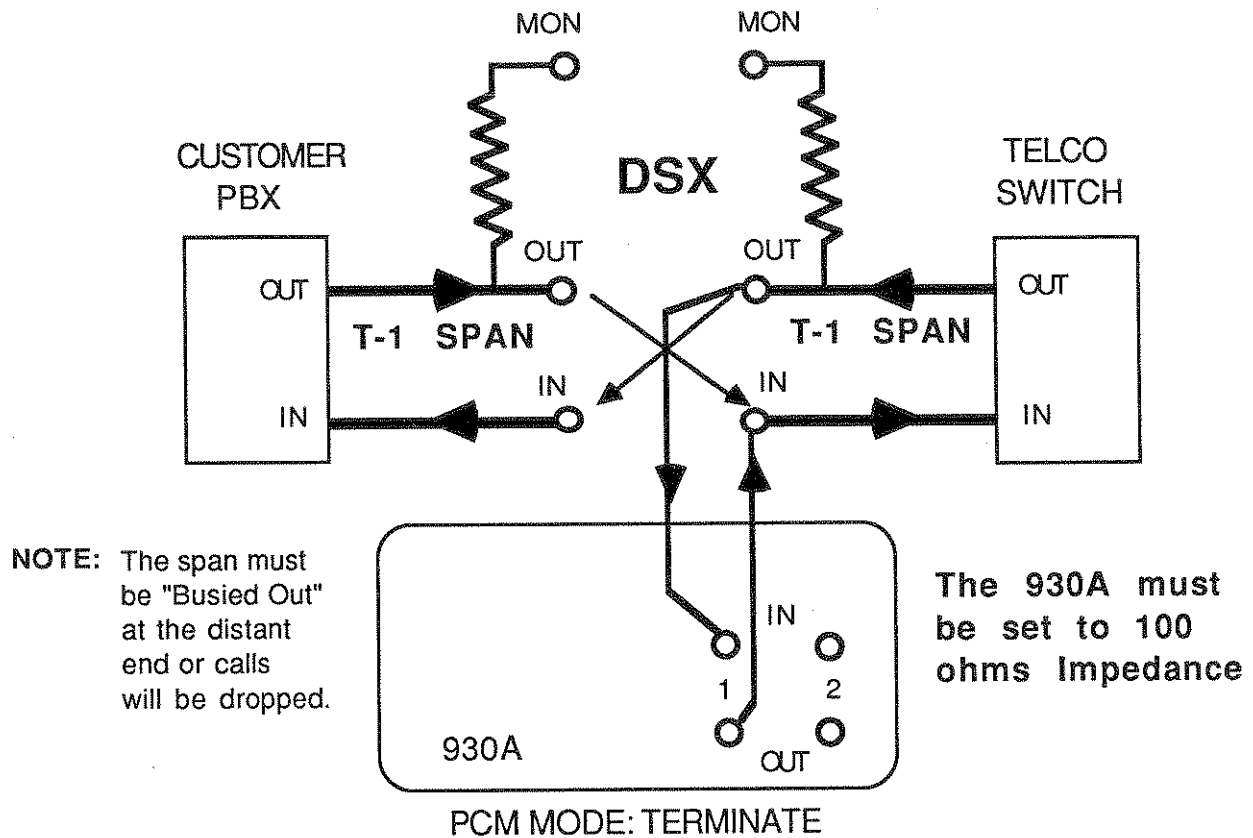

TERMINATING A T1 SPAN FOR OUT-OF-SERVICE TESTING
FIGURE 4-3

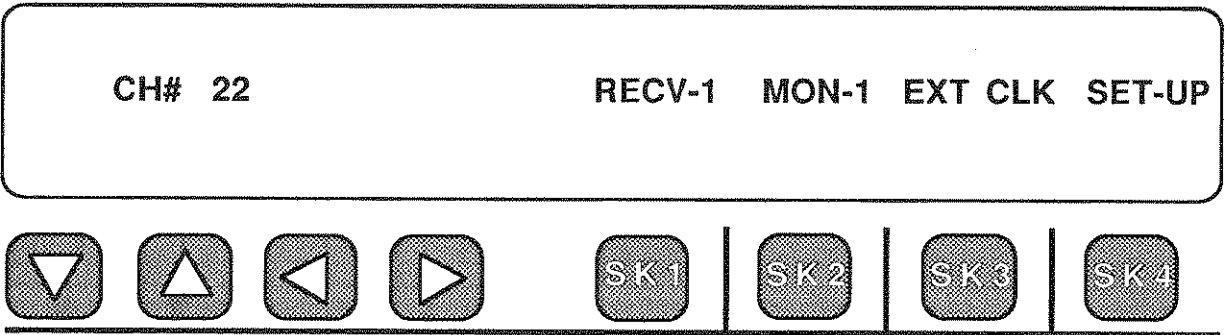

To set the 930A into the **TERMINATE** mode, press Softkey 2 (under **MON-1** in the example above) and the choices appear on the display as:

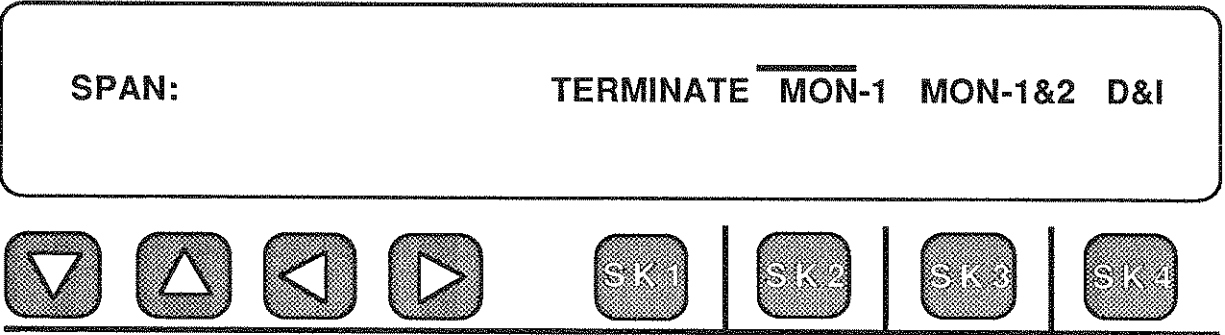

To Terminate the span, press Softkey 1 to choose the **TERMINATE** mode. The 930A display will come back as:

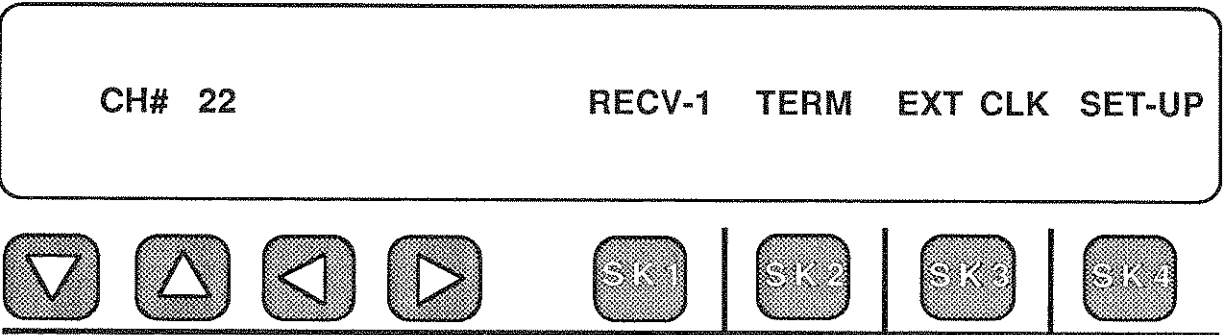

Unlike the other modes, **TERMINATE** gives you a choice of Clock Source. You can be **Loop-Timed** to the span clock, or you can have the 930A supply the clock. The display above shows Loop-Timing.

If you know you need to supply the clock from the 930A, press Softkey 3 (under **EXT CLK**) and your choices will appear on the display shown below:

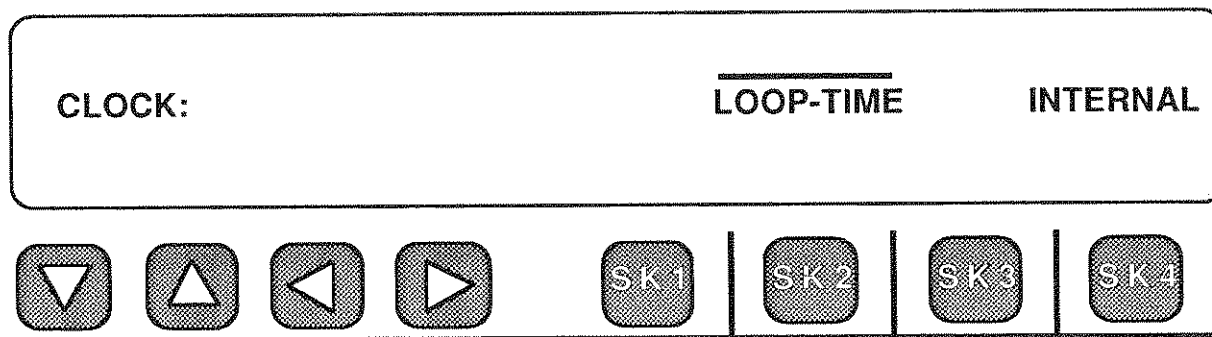

If you want the 930A to supply the T1 clock, press Softkey 4 (under **INTERNAL**) and the main **PCM** display will reappear as:

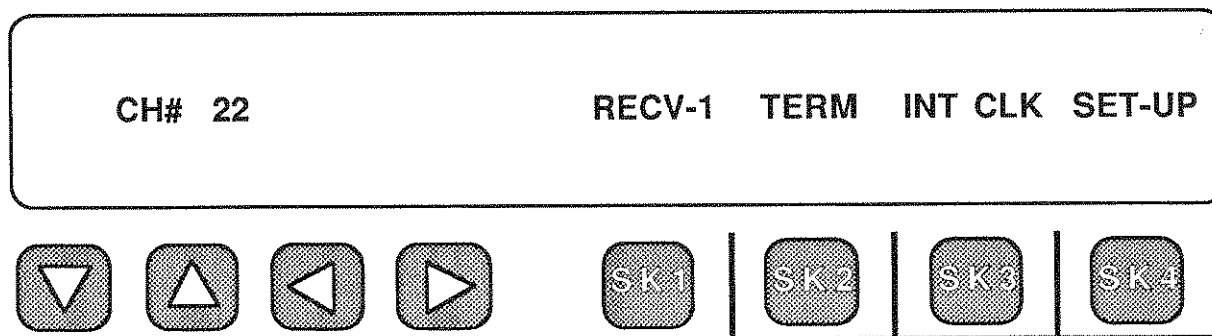

In either case, you are ready to begin testing. You can use **DIAL/RING** to place a call into the switch, the **RETURN LOSS**, **SEND TONE**, **MEASURE TONE** and **MEASURE NOISE** functions. Under the **OPTION MENU** key, the standard features which come with the 930A, and which are of particular use in this mode, are Option Menus 1, 2, 8, 9, 10, 12, 15, 30, 31, 32 and 33. If you purchased options such as the Digit Receiver/Analyzer, Bit Error Testing, or the VF Data Tests, their menus will also be of interest to you.

Trunk transmission and signaling can be tested completely before the trunk is placed in service using the **TERMINATE** mode to simulate either end of a circuit. Place the 930A in **EXT CLK** mode to simulate the loop side of the circuit toward a switch. To test toward the loop (simulate the switch toward the customer) simply set the 930A to **INT CLK** mode and transfer the test cords to the **DSX** jacks looking out toward the Office Repeater or the customer's CSU.

4-5 DROP AND INSERT TESTING ON A T1 LINE

The procedure for Drop and Insert testing is purposely a two stage process when using the 930A. You monitor both directions of transmission using the **MON-1&2** mode first and try to solve your problems. In probably 85 to 90% of the cases, this is all you need to do to find the direction of the problem, and its source. **MON-1&2** is the logical first step toward a **D&I** test set up. You begin by connecting the 930A to the DSX monitor jacks. The diagram is repeated below:

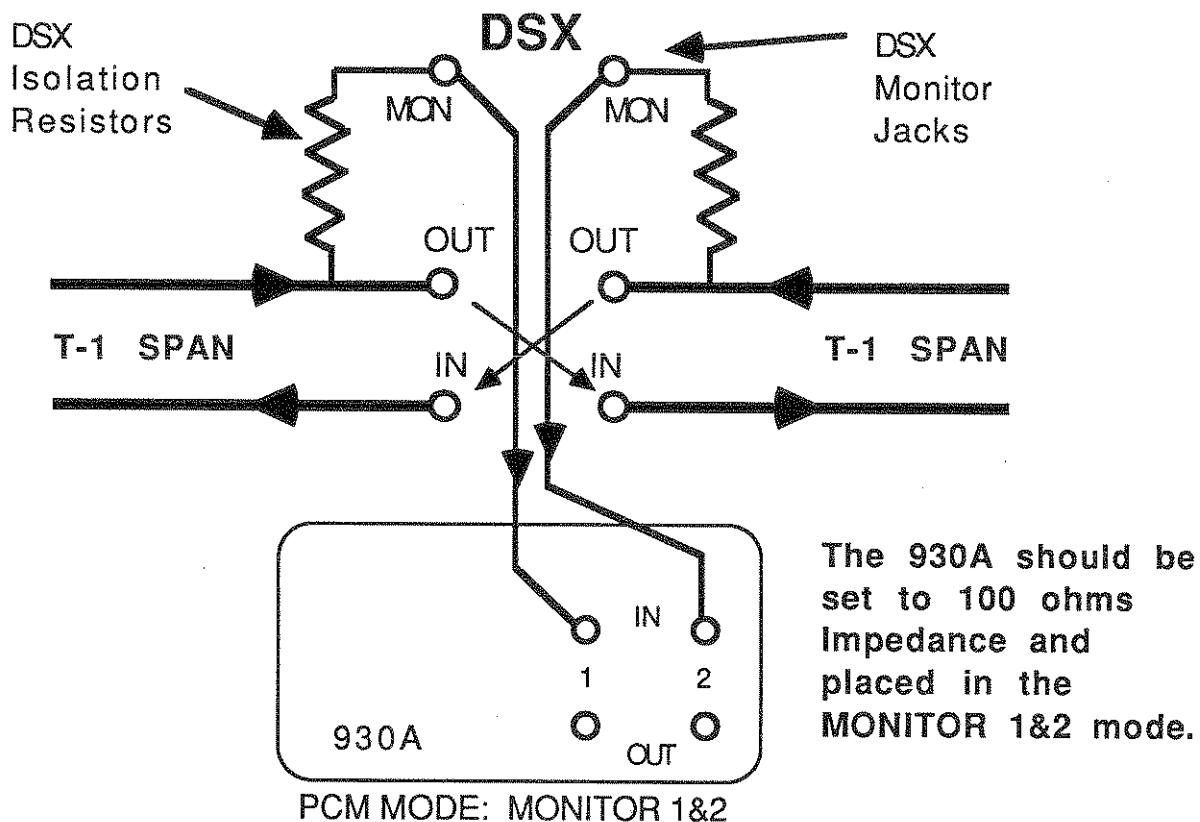

PREPARATION FOR DUAL DIRECTION DROP AND INSERT
FIGURE 4-4

The 930A display should look like the one below when you have correctly set up the main PCM display.

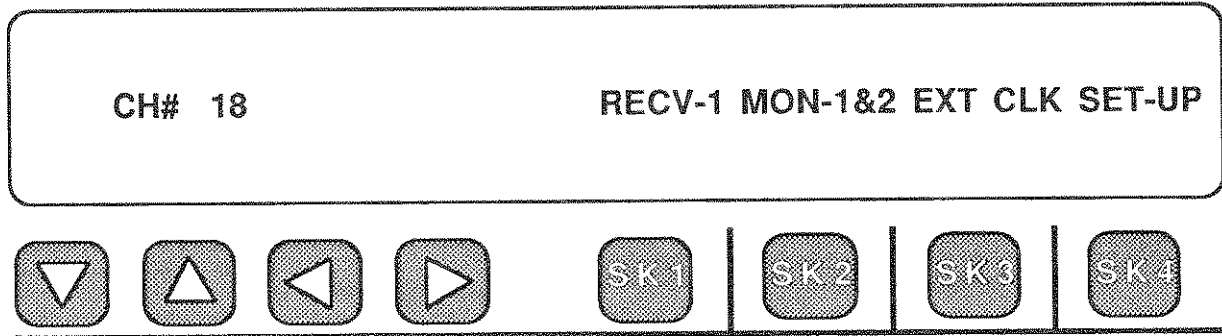

The channel number could be any one of 24. You may, for example, have to originate a call on PCM channel 18 toward a PBX at the far-end of the circuit.

WARNING: If the 930A reports PCM errors. Do not proceed to the next step. Verify what the connection problem is and correct.

The next step in the process is to leave the 930A set to **MON-1&2** and connect test cords from **PCM OUT 1** and **PCM OUT 2** to the input jacks on the DSX. **Warning!** This is where you run the risk of momentarily opening the span because the **DSX** jacks are "break-before-make" types. **You will also need 100 ohm termination plugs to plug into the output jacks of the DSX to keep the span from oscillating.** If you do take a "Hit" for any reason you will see a remote alarm indication on your 930A for a few seconds while the span reframes.

The connection diagram, Figure 4-5 is shown on the following page.

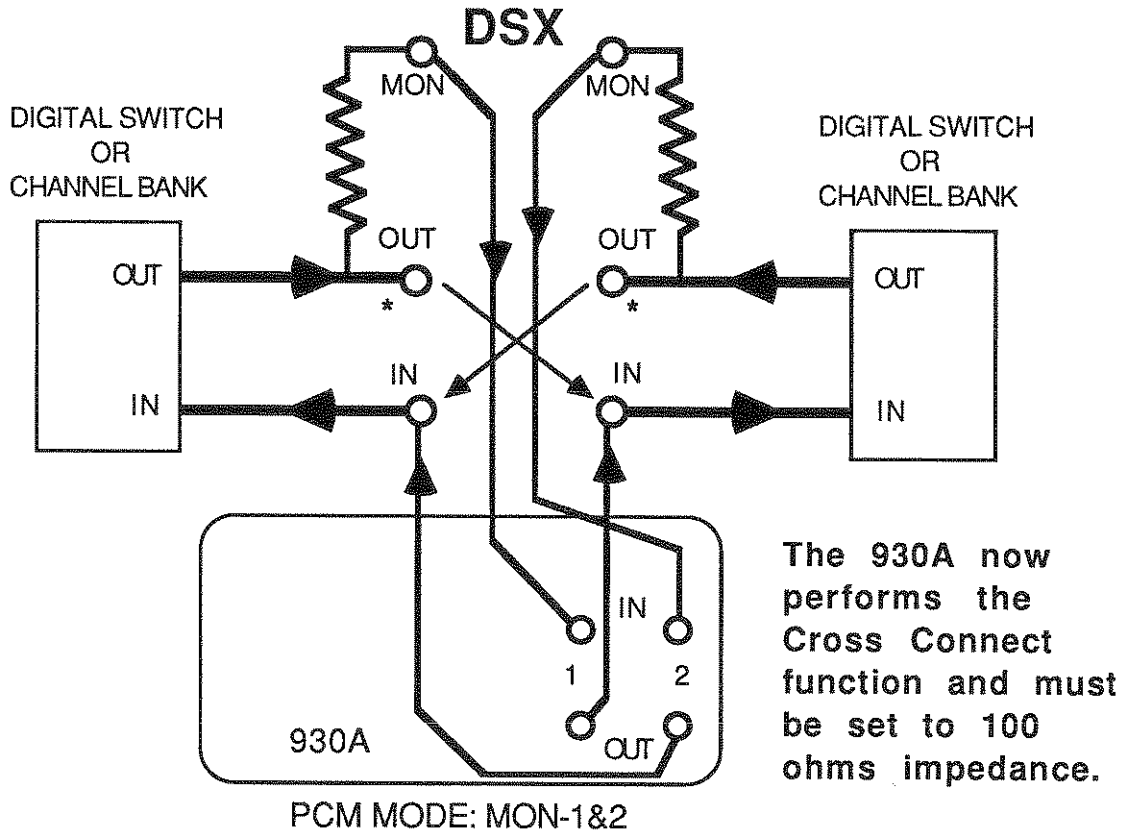

(* 100 Ohm Termination Plugs Required)

**TEST CORD CONNECTIONS FOR DROP AND INSERT TESTING
FIGURE 4-5**

Be sure to place 100 OHM terminating plugs into the DSX output jacks as shown above to prevent the span from oscillating.

The final step is easy. You start from the main PCM display which was set to MON-1&2 as repeated below:

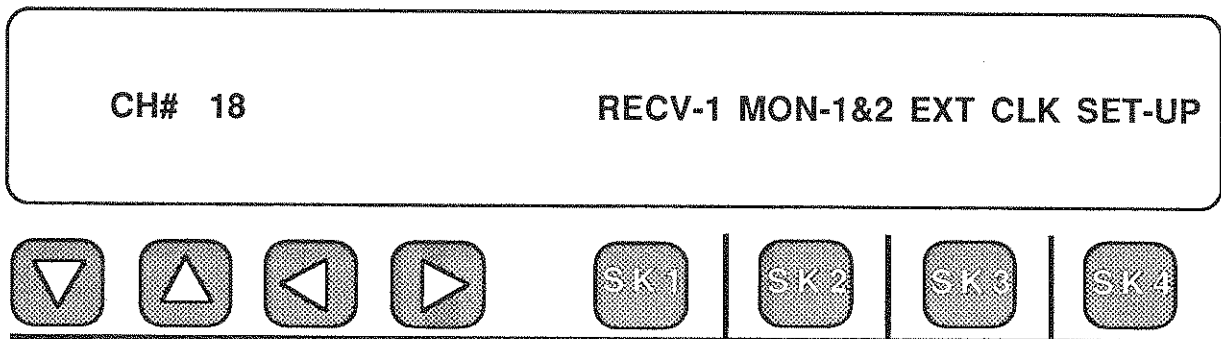

Press Softkey 2 (under MON-1&2) and your choices will appear as:

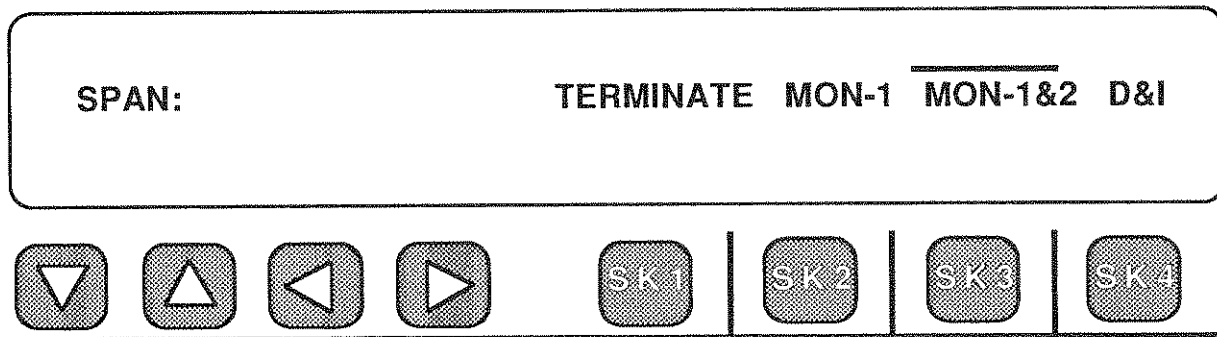

Note that the cursor now appears over MON-1&2 which is the mode you were in. Press Softkey 4 (under D&I) and the currently selected channel will be dropped (the other 23 channels pass through undisturbed). Make sure the channel is idle before selecting D&I.

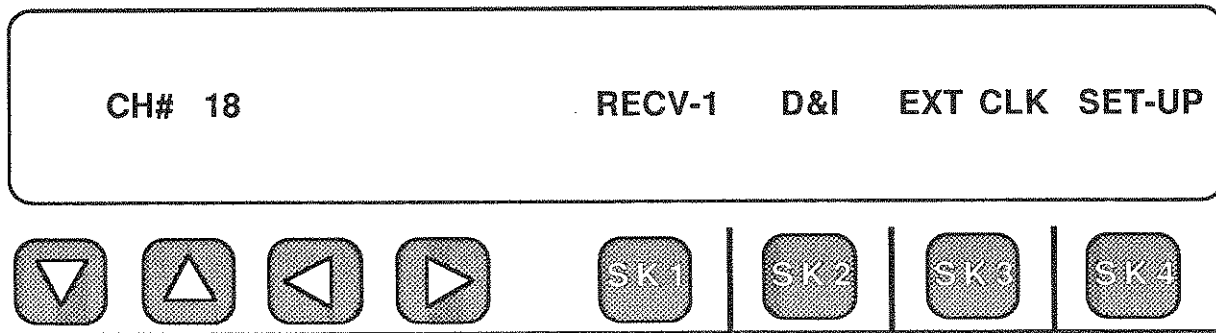

This part of the process is hitless which means that once you have the four test cords inserted, you are past the danger of dropping the span.

NOTE: If you are in Drop and Insert and change channels, the 930A will revert back to MON 1&2. This is a safeguard against interfering with a working channel inadvertently.

The diagram below shows the test cord connections which are the same for the D&I and MON-1&2 modes.

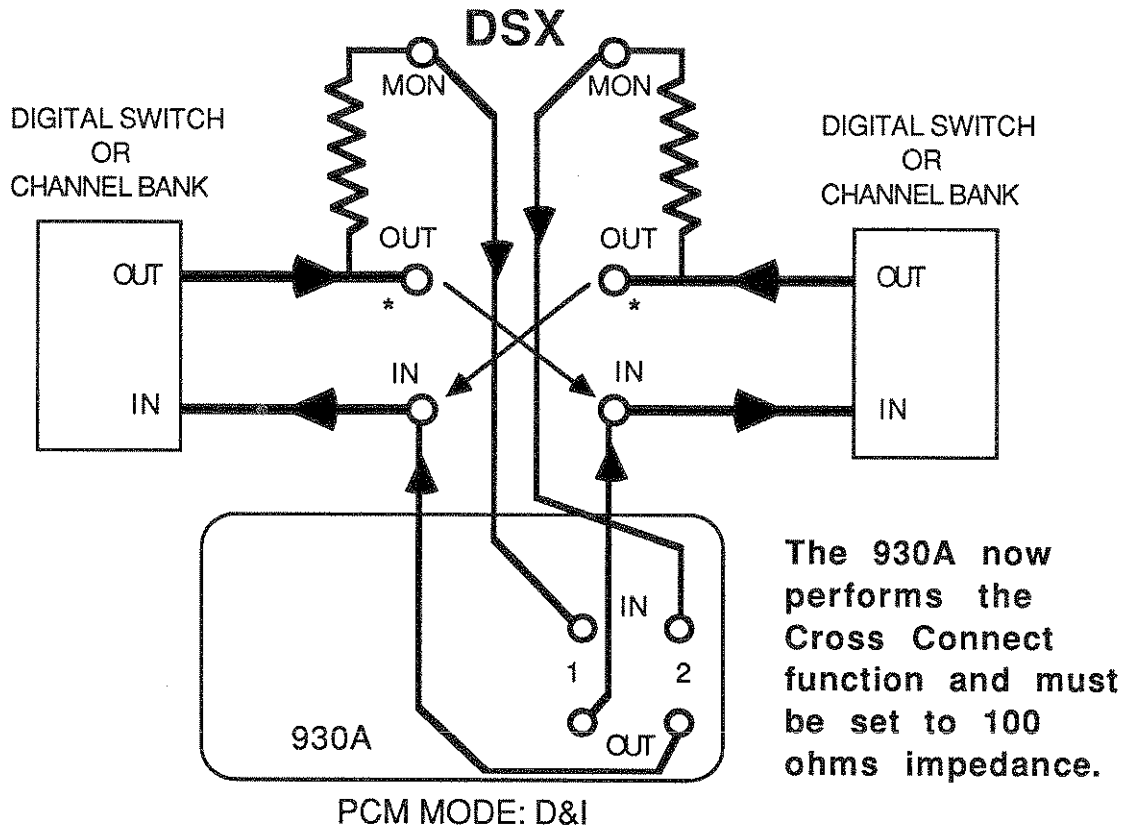

(* 100 Ohm Termination Plugs Required)

**DUAL DIRECTION DROP AND INSERT
FIGURE 4-6**

4-6 HOW TO DEFINE YOUR OWN ON/OFF HOOK STATES

If you absolutely must, the 930A will allow you the flexibility to define your own **ON** and **OFF HOOK** states of the A/B/C/D bits. The **NORMAL** supervision default is the most useful, followed by **FXS/FXO** supervision. You can redefine what the 930A sends and recognizes as an **ON** or **OFF HOOK**. This is not usually necessary.

To redefine what the Hookswitch sends, instead of the default conditions, start at the main PCM display. An example follows.

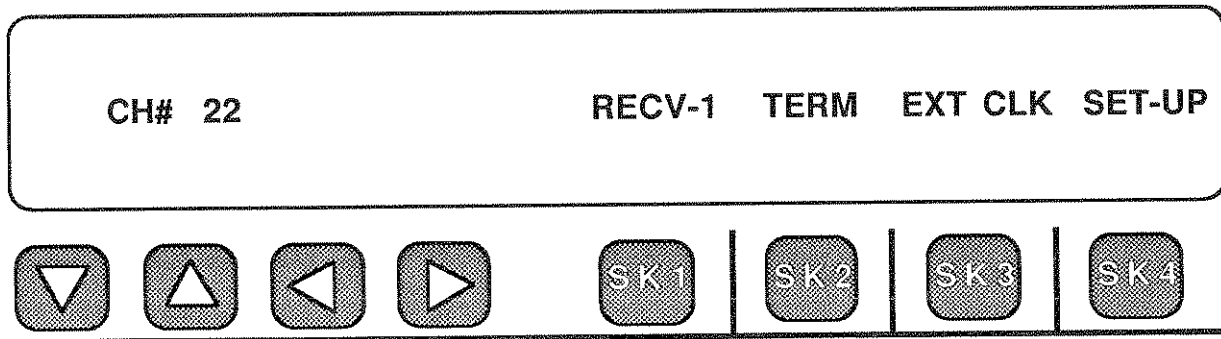

Press Softkey 4 (under **SET-UP**) and the first set-up menu you see will be:

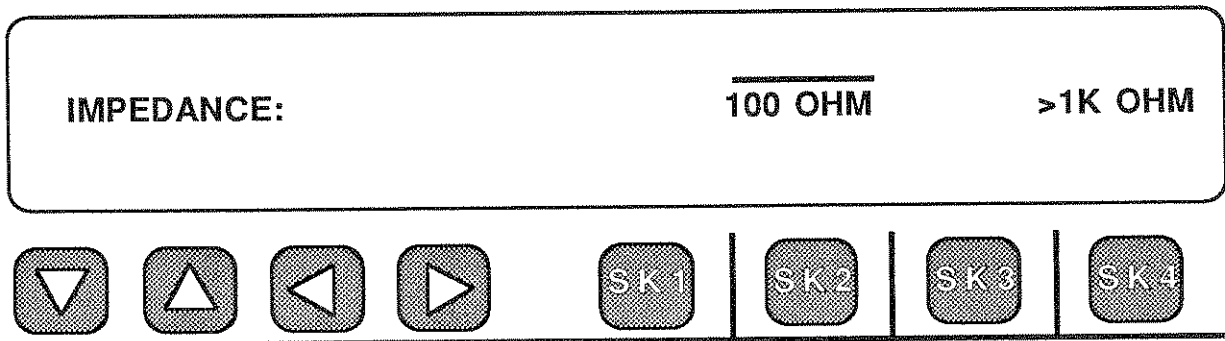

To get to the **SUPERVISION** set-up, press the **UP** Arrow key to page up through the set-ups to the following:

Note the cursor over the A bit position of the ON HOOK state. You can change the state of the **ON HOOK** A, B, C or D bits by moving the cursor over the bit you want to change with the **LEFT/RIGHT** Arrow keys and then entering a 1 or a 0 from the keypad. You can also change states using the **UP/DOWN** Arrow keys. You change the **OFF HOOK** states by pressing Softkey 3 and the cursor will move over to the **OFF HOOK** side.

Suppose you were on a D4 Superframe span and you wanted an **ON HOOK** to be 01, instead of 00, and an **OFF HOOK** to be 10, instead of 11. You would move the cursor over the B bit position and enter a 1 from the keypad so the display looked like:

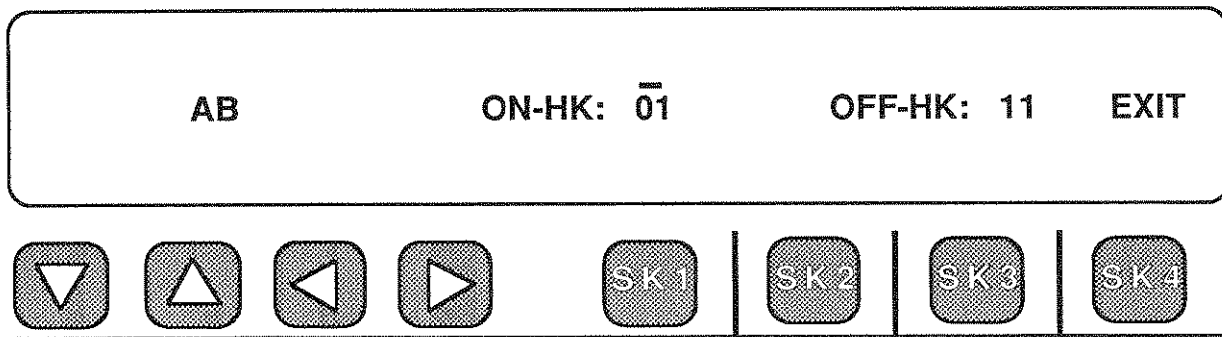

Next, you would press Softkey 3, use the **Right** Arrow key to move the cursor over the **OFF-HK B** bit, and enter a **0**. The display would look like:

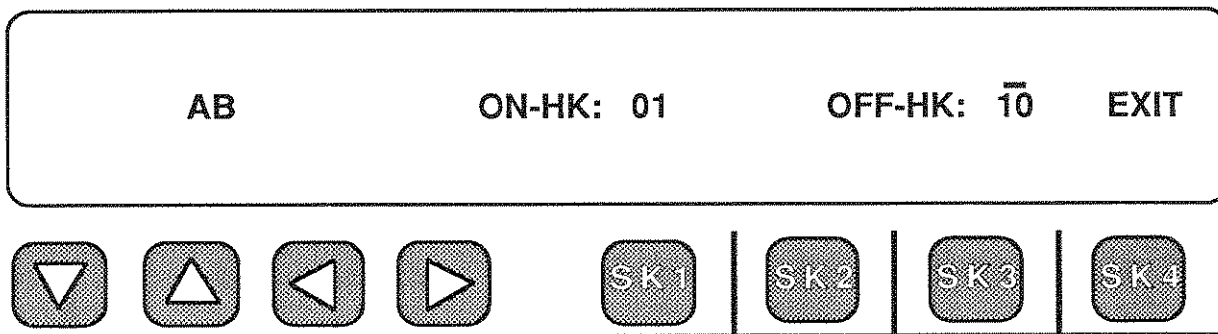

Now you could return to the main menu by pressing Softkey 4. **Now when you go OFF HOOK** using the front panel Hookswitch, the 930A will send 10 instead of 11. Likewise, the **ON HOOK** will be 01 instead of 00.

When the 930A detects the **OFF HOOK** bit pattern, the Off-Hook LED on the front panel lights. When the **ON HOOK** bit pattern is detected, the On-Hook LED lights. If neither bit pattern is detected, no LEDs light. If the supervision LEDs on your front panel are not lit, the supervision bit patterns are not correctly defined.

Remember to reset the 930A back to **NORMAL** when you are finished testing in the **DEFINED** mode. You will have problems drawing dial tone and getting the Supervision LED's to read properly on a regular PCM channel if you do not.

4-7 HOW TO SELECT FOREIGN EXCHANGE SUPERVISION

You must purchase **Option 930A-25 (FXO/FXS Supervision)** to operate on Foreign Exchange circuits on **PCM** Trunks. The option appears under the **PCM SET-UP** menu for supervision.

To select **FX** supervision follow these steps:

First, start from the main PCM display. An example of the display for the **D&I** mode follows.

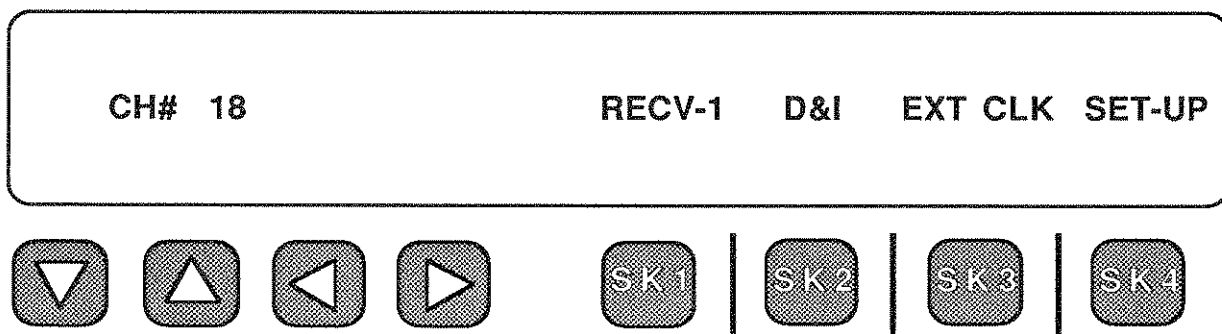

Next, press Softkey 4 (under **SET-UP**) to get into the set-up menus, starting at **IMPEDANCE**.

To select FXO (or Central Office end) supervision, press Softkey 4 (under FXO) and the set-up display will momentarily show your choice as:

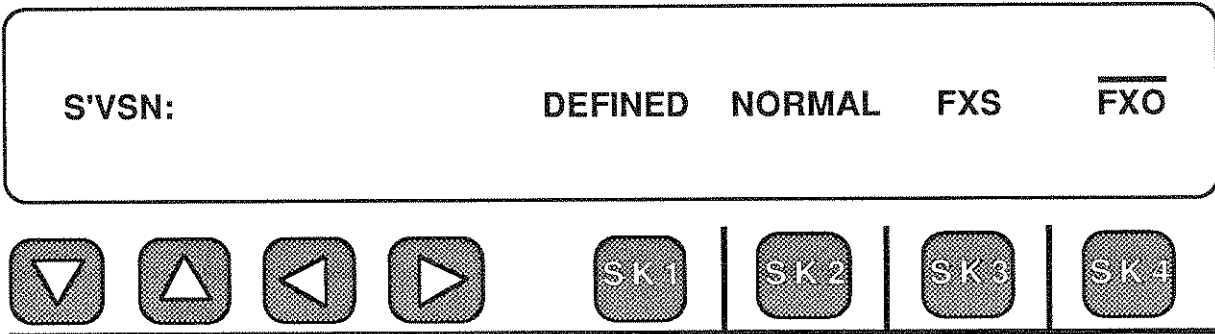

In either case, the front panel Hookswitch will now follow the type of Foreign Exchange supervision you selected.

Remember to reset your supervision to NORMAL when you are finished testing in FXS/FXO so that you can operate on regular PCM channels.

4-8 DROP AND INSERT TEST CORD CONNECTIONS AT A T1 CSU

The block diagram of a typical T1 Customer Service Unit (CSU) is shown in Figure 4-7 below. From this diagram, you can see that the test access jacks for monitoring are not wired the same as those in a DSX jack field. For this reason it is not possible to use these jacks when connecting the 930A for Drop & Insert testing at a CSU.

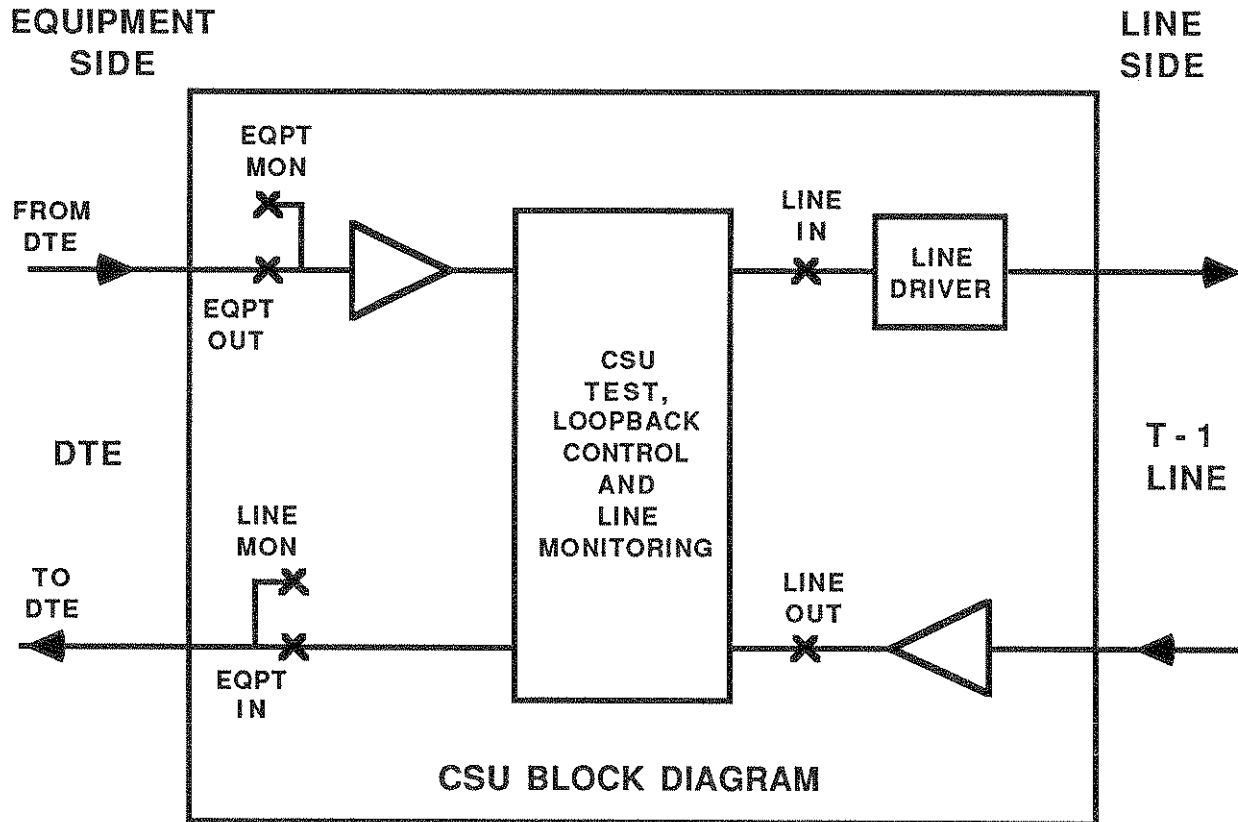

FIGURE 4-7

In order to perform a D&I at the CSU, the 930A must pass the traffic from Equipment Out to Line In and from Line Out to Equipment In. Since we cannot use the monitor jacks, it is almost a sure bet that the span will be dropped at some point during the procedure of connecting the test cords. For this reason it is suggested that this procedure be done out of hours or after the users have been alerted. The same warning applies when removing the test cords.

The following diagrams describe the recommended procedure for connecting test cords between the 930A and a T1 CSU to do a D&I test.

The first step is to place the 930A in the MON 1&2 mode with its settings at 100 OHMS impedance, D4 Superframe (or Extended Superframe as appropriate), AMI line code, D3/D4 channel sequence and normal supervision. These are the most common settings. They can always be changed later.

Next, plug test cords into the two inputs of the 930A and then plug the other ends of these test cords into the LINE OUT and EQPT OUT jacks on the CSU as shown below.

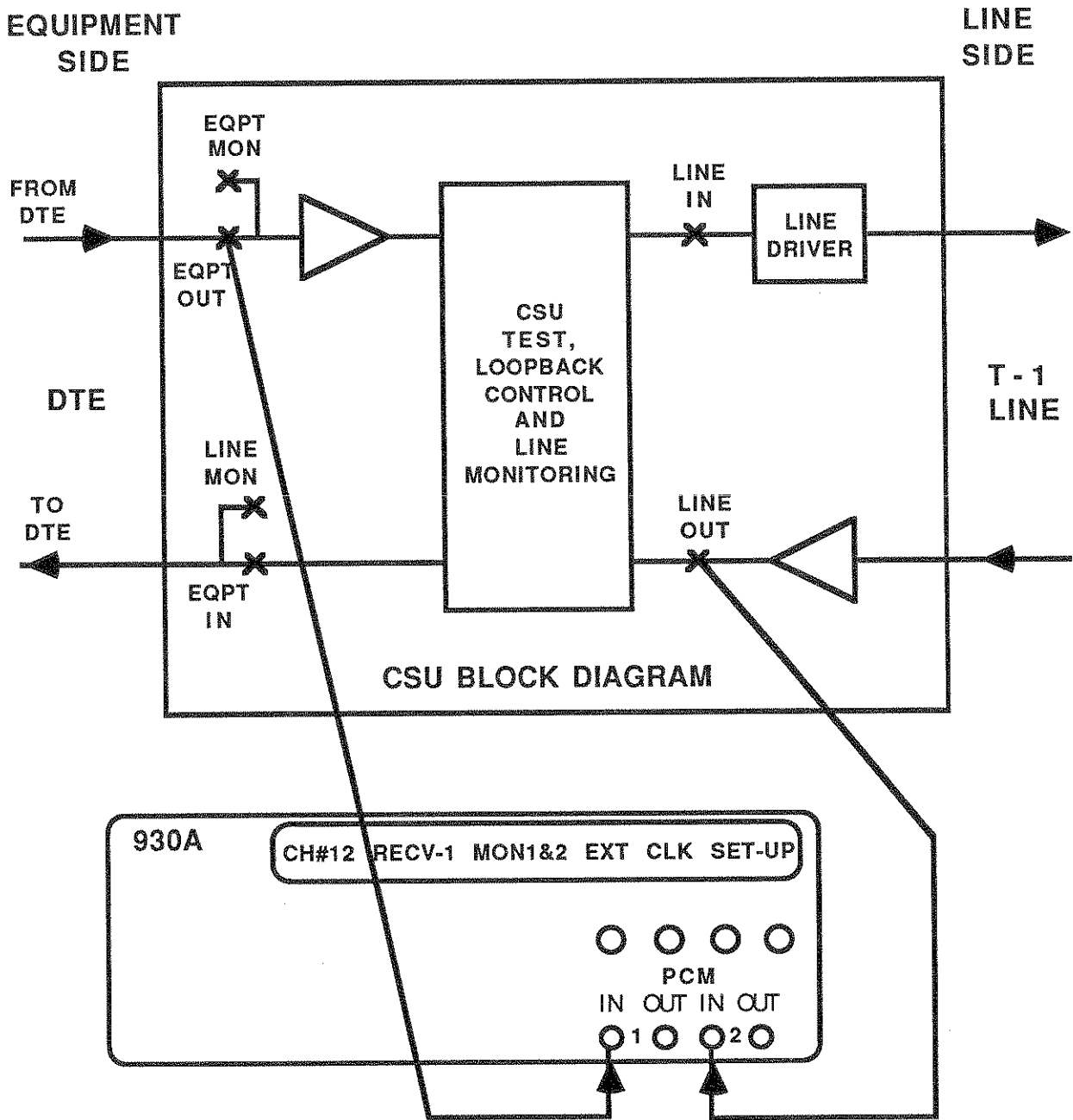

TEST CORD CONNECTION AT T-1 CSU
FIGURE 4-8

Next, connect test cords from the 930A outputs to the CSU LINE IN and EQPT IN jacks as shown below.

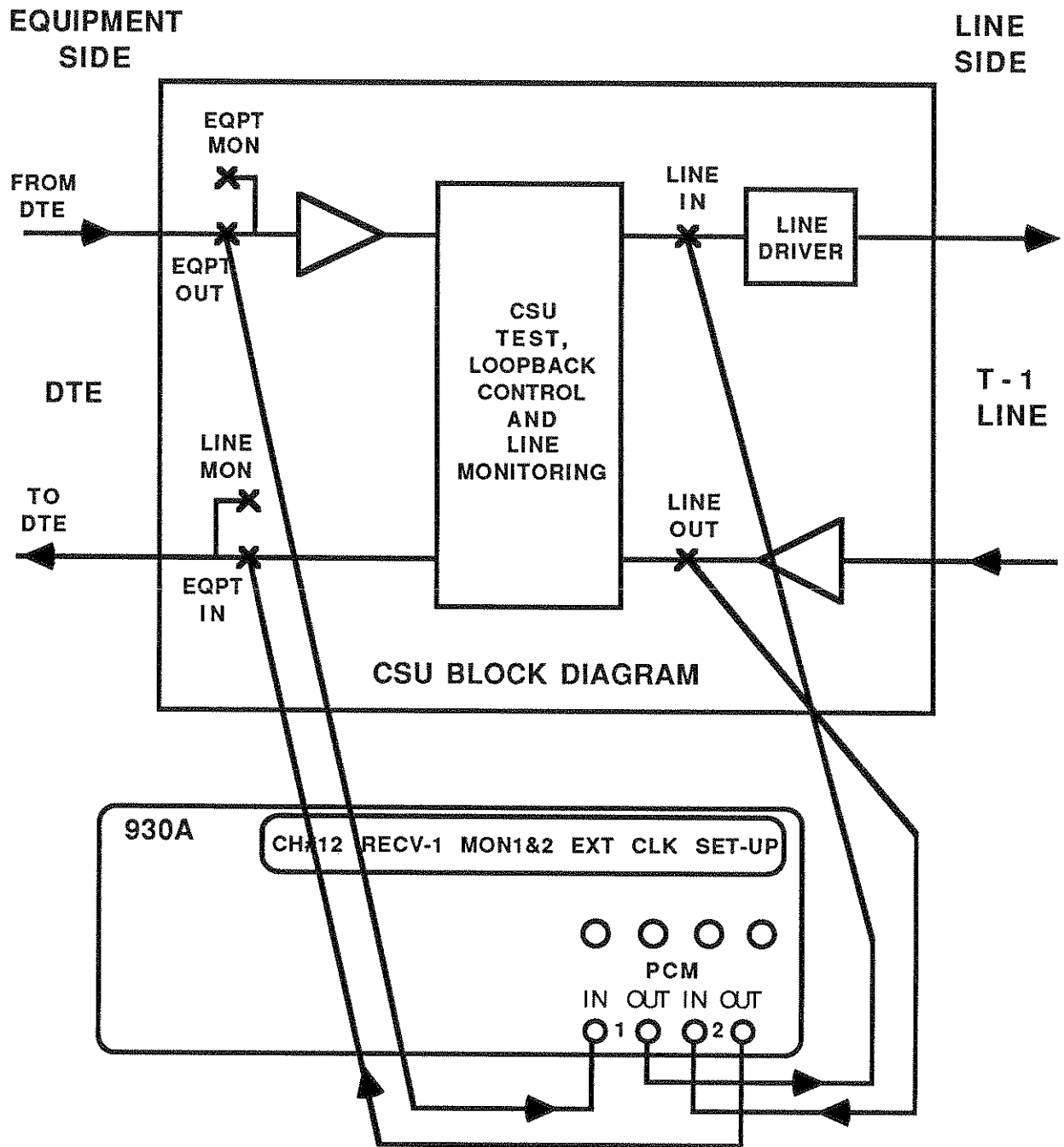

CSU LINE IN AND EQUIP JACKS
 FIGURE 4-9

After a few seconds the remote alarm indication will clear and the 930A will frame up to the signal. If you happen to be on an ESF line the 930A will automatically frame up to it.

Once you have successfully framed up to the T1 signal, the last step is to place the 930A in the D&I mode.

Pressing the softkey under MON 1&2 brings up the selections and pressing the softkey under D&I will select that mode. The display and connections are shown below.

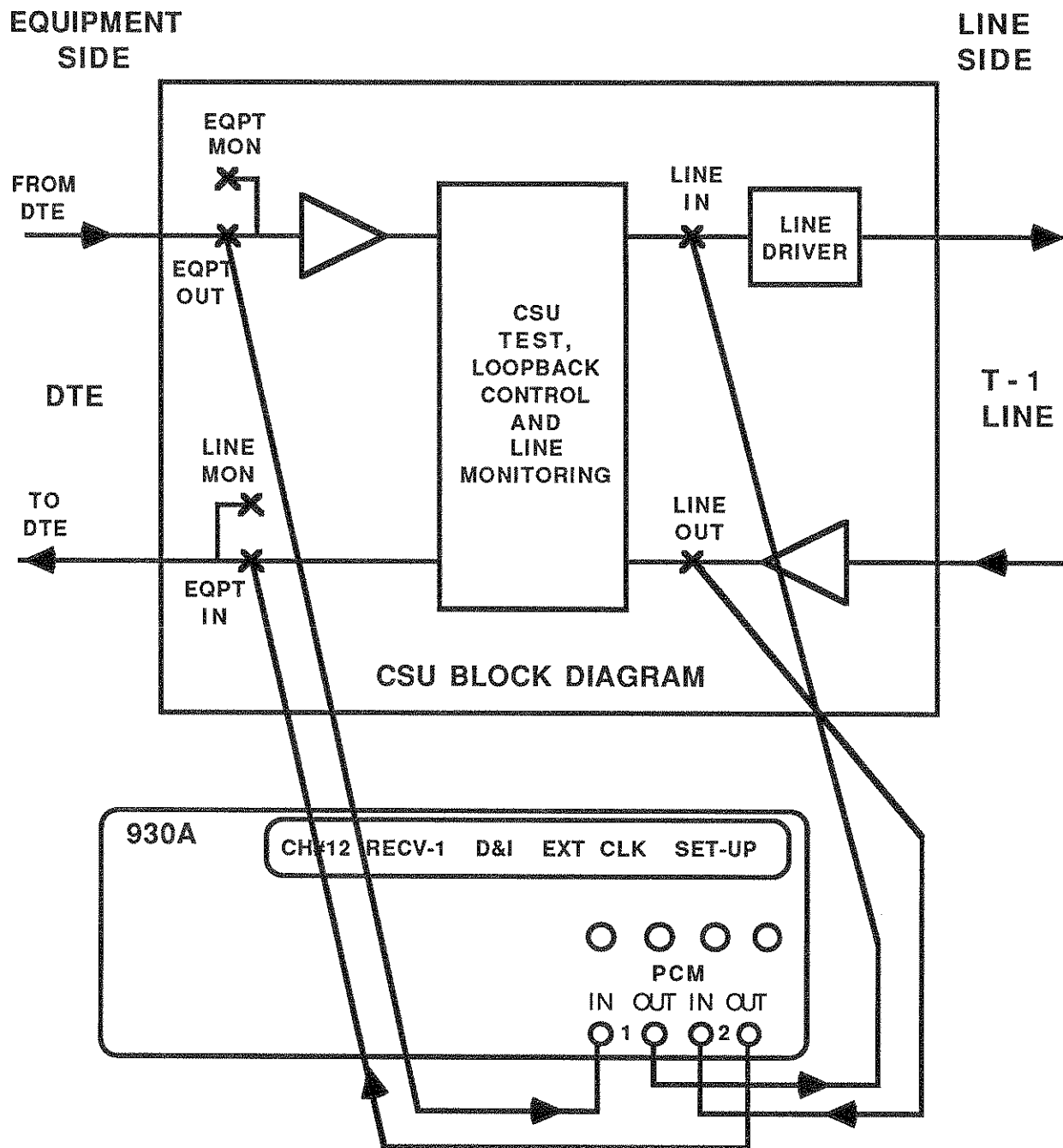

CSU DROP AND INSERT FIGURE 4-10

At this point you can perform any testing on a Drop and Insert basis that the 930A is capable of. This includes sending or receiving calls, transmission measurements, supervision monitoring and DS-0 Bit Error Testing.

SECTION V EXTENDED FEATURES/MENU OPTIONS

5-0 EXTENDED FEATURES/MENU OPTIONS

5-0.1 FINDING WHAT YOU WANT UNDER THE OPTION MENU KEY

The good part about the **OPTION MENU** key is, it permits the capabilities of the 930A to be expanded without replacing the front panel. The bad news is, multiple functions are located under a single key. The following is a list of the Menu Options which come standard with all 930A's. A complete listing of all Menu Options (standard plus optional) is listed in Table 5-1 on pages 5-3 and 5-4.

5-0.2 USEFUL TRUNK TYPE/MENU OPTION COMBINATIONS

A frequently asked question is "What tests can I do when I am in a particular Trunk Type?". This section provides a quick guide to the menu numbers of the functions you will need for the most common tests. There are many others as well, but these are commonly used.

On Loop Start, Ground Start, E&M, SF, and T1 PCM Trunks

| <u>TO</u> | <u>GO TO</u> | <u>SECTION</u> |
|--|--|----------------|
| Place a Feature Group D, TSPS or any Wink Start call | DIAL/RING and Menu Option 2 | 5-2 |
| Receive a call | Menu Option 4 | 5-4 |
| Set-up Printer Port | Menu Option 3 | 5-3 |
| Measure Wink Timing | Menu Option 2 or 4 to set-up and then Menu Option 9 for results. | 5-2 5-4 |
| Measure Supervision Timing | Menu Option 8 | 5-8 |

On T1 PCM Trunks Only

| <u>TO</u> | <u>GO TO</u> | <u>SECTION</u> |
|---|----------------|----------------|
| Check A, B, C & D Bits in all 24 Channels | Menu Option 20 | 5-20 |
| Monitor a T1 span for Slips, Errors, etc. | Menu Option 43 | 5-43 |
| Measure T1 Voltage | Menu Option 41 | 5-41 |
| Check Clock Difference on a T1 | Menu Option 42 | 5-42 |
| Make a T1 Bit Error Test | Menu Option 45 | 5-45 |
| Check 24 Hour Error History | Menu Option 44 | 5-44 |
| Inject Errors, BPV's, etc. | Menu Option 46 | 5-46 |

TABLE 5-1
MENU OPTION NUMBERS

| <u>MENU OPTION NUMBER</u> | <u>DESCRIPTION</u> | <u>PURCHASED OPTION</u> |
|---------------------------|---------------------------|-------------------------|
| OPTIONNUMBER: 1 | MODIFY DIAL/RING | STANDARD |
| OPTIONNUMBER: 2 | SEND DIGIT SEQUENCES | STANDARD |
| OPTIONNUMBER: 3 | REMOTE CONTROL | OPTION 930A-10C |
| OPTIONNUMBER: 4 | DIGIT RECEIVER | OPTION 930A-01 |
| OPTIONNUMBER: 5 | REN-3 LOAD | OPTION 930A-13 |
| OPTIONNUMBER: 6 | D.C. VOLT/AMP METER | STANDARD |
| OPTIONNUMBER: 7 | SUPERVISION THRESHOLDS | STANDARD |
| OPTIONNUMBER: 8 | SUPERVISION MONITOR | STANDARD |
| OPTIONNUMBER: 9 | WINK TIMING | STANDARD |
| OPTIONNUMBER: 10 | FREQUENCY SWEEP | STANDARD |
| OPTIONNUMBER: 11 | IMPULSE NOISE & HITS | OPTION 930A-07 |
| OPTIONNUMBER: 12 | WINK MARGINING | OPTION 930A-01 |
| OPTIONNUMBER: 13 | PHASE/AMPLITUDE JITTER | OPTION 930A-18 |
| OPTIONNUMBER: 14 | SET TIME AND DATE | OPTION 930A-10C |
| OPTIONNUMBER: 15 | BEEP ON ERROR | STANDARD |
| OPTIONNUMBER: 16 | DIGIT RECEIVER TIMEOUT | OPTION 930A-01 |
| OPTIONNUMBER: 17 | ENVELOPE DELAY DISTORTION | OPTION 930A-19 |
| OPTIONNUMBER: 18 | PEAK/AVERAGE RATIO | OPTION 930A-06 |
| OPTIONNUMBER: 19 | 4-TONE INTERMODULATION | OPTION 930A-20 |
| OPTIONNUMBER: 20 | 24 BIT DISPLAY | OPTION 930A-8E -9E |
| OPTIONNUMBER: 21 | TOGGLE A/B BITS | OPTION 930A-8E,9E |
| OPTIONNUMBER: 22 | ABSOLUTE DELAY | OPTION 930A-21 |
| OPTIONNUMBER: 23 | RESERVED | |
| OPTIONNUMBER: 24 | RESERVED | |
| OPTIONNUMBER: 25 | FAREND RESPONDER | OPTION 930A-12 |
| OPTIONNUMBER: 26 | ROTL/NEAREND RESPONDER | OPTION 930A-12 |
| OPTIONNUMBER: 27 | ROTL INTERROGATOR | OPTION 930A-12 |

**TABLE 5-1 (Continued)
MENU OPTION NUMBERS**

| <u>MENU OPTION NUMBER</u> | <u>DESCRIPTION</u> | <u>PURCHASED OPTION</u> |
|---------------------------|---------------------|-------------------------|
| | <u>OPTION</u> | |
| OPTIONNUMBER: 28 | TRANSPONDER TEST | OPTION 930A-35 |
| OPTIONNUMBER: 29 | CALL 102 LINE | OPTION 930A-29 |
| OPTIONNUMBER: 30 | ADJUST TLP | STANDARD |
| OPTIONNUMBER: 31 | SEND HOOK FLASH | STANDARD |
| OPTIONNUMBER: 32 | DIAL-UP TESTLINE | STANDARD |
| OPTIONNUMBER: 33 | DIAL-UP SWEEP | STANDARD |
| OPTIONNUMBER: 34 | SELECT REPORTS | OPTION 930A-10 |
| OPTIONNUMBER: 35 | DUAL TONE SENDER | STANDARD |
| OPTIONNUMBER: 37 | LINE STATUS | OPTION 930A10C |
| OPTIONNUMBER: 39 | REMOTE AUDIO | OPTION 930A-47 |
| OPTIONNUMBER: 40 | SEND PCM ALARMS | OPTION 930A-8E |
| OPTIONNUMBER: 41 | READ T1 VOLTAGE | OPTION 930A-9E |
| OPTIONNUMBER: 42 | T1 WANDER | OPTION 930A-8E |
| OPTIONNUMBER: 43 | ERROR COUNTERS | OPTION 930A-9E |
| OPTIONNUMBER: 44 | T1 ERROR HISTORY | OPTION 930A-8E |
| OPTIONNUMBER: 45 | T1 ERROR INJECT | OPTION 930A-9E |
| OPTIONNUMBER: 46 | DS-1 BIT ERROR RATE | OPTION 930A-9E |
| OPTIONNUMBER: 47 | APS TEST | OPTION 930A-22 |
| OPTIONNUMBER: 48 | CSU EMULATION | OPTION 930A-22 |
| OPTIONNUMBER: 50 | BATCH MODE | OPTION 930A-44 |
| OPTIONNUMBER: 51 | TEST RESULTS | OPTION 930A-29 |
| OPTIONNUMBER: 52 | E911 EMULATION | OPTION 930A-29 |
| OPTIONNUMBER: 56 | DS-0 BIT ERROR RATE | OPTION 930A-37 |
| OPTIONNUMBER: 57 | DS-O LOOPBACK | OPTION 930A-22 |
| OPTIONNUMBER: 65 | GND-ST COIN PHONE | OPTION 930A-22 |
| OPTIONNUMBER: 87 | TPT BURST LENGTH | STANDARD |
| OPTIONNUMBER: 88 | POST-TPT DELAY | OPTION 930A-12 |
| OPTIONNUMBER: 89 | PRINTER HANDSHAKE | OPTION 930A-10 |

**TABLE 5-1 (Continued)
MENU OPTION NUMBERS**

| <u>MENU OPTION NUMBER</u> | <u>DESCRIPTION</u> | <u>PURCHASED OPTION</u> |
|---------------------------|------------------------|----------------------------------|
| OPTIONNUMBER: 90 | DSPMEMORYTEST | OPTION 930A-01 |
| OPTIONNUMBER: 91 | SOFTWAREVERSION | STANDARD |
| OPTIONNUMBER: 92 | SOFTWARECOLD-BOOT | STANDARD |
| OPTIONNUMBER: 93 | TEST DISPLAY | STANDARD |
| OPTIONNUMBER: 94 | LIST OPTIONS | STANDARD |
| OPTIONNUMBER: 95 | DRY CIRCUIT | STANDARD |
| OPTIONNUMBER: 96 | TEST EXTENDED DRAM | OPTION 930A-32 |
| OPTIONNUMBER: 97 | HOLD CONTROL | STANDARD |
| OPTIONNUMBER: 98 | ESF BOARD SOFTWARE VER | OPTION 930A-8E OPTION 930A-9E |

Menu Option Numbers which are not used are reserved for future expansion.

5-0.3 HOW TO GET INTO THE MENU ONCE YOU FIND IT

There are two ways you can get into the Menu Option of your choice. After pressing the **OPTION MENU** key you will see the last selected menu. It could be, for example, **OPTION NUMBER: 6 DC VOLT/AMP METER**. Suppose you want to adjust the Transmission Level Point (TLP) of the receiver. You will need to get to Menu Option 30. **One method** is to enter the number 30 using the keypad and press **ENTER**. This gets you right inside Menu 30 and you can start adjusting. **The other way** to do this is to page upward through the menus using the **UP** Arrow key (or **DOWN** Arrow key as appropriate). When you get to Option Number 30 this way, you will still be on the outside. In order to get inside the menu, you simply press any softkey (**SK1**, **SK2**, **SK3**, or **SK4**) under the display and this will get you inside the menu. This procedure is true for all Menu Options, whether they are standard or optional.

You can get out of any of the Menu Options by pressing the **OPTION MENU** key, or any of the other 6 function keys, as many times as necessary. In many cases, one of the softkeys inside the Menu Option will be labeled **EXIT**, and pressing this softkey will have the same effect. **Remember** that you enter a Menu Option from the outside by pressing any softkey and you can back out of any menu by pressing the **OPTION MENU** key.

NOTE:

The option numbers for the **OPTION MENU** functions should not be confused with the order numbers of purchased options.



NOTE: To store the parameters which have been set up in a Menu Option, it is necessary to exit from that option. To do this, press the **OPTION MENU** key as many times as necessary to get outside, then press the **STORE** key and enter the desired storage location number (01 to 39). The only exception to this is **Option Number 1: MODIFY DIAL/RING**. This is explained in greater detail in Section 5-1.

5-1 CHANGING THE DIAL/RING DEFAULTS (MENU OPTION 1)

You must first select the type of digits you want to modify under the DIAL/RING function before going to the OPTION MENU function and selecting Option Number 1.

After you have selected the type (MF, DTMF or DP) of digits you are going to modify, you can perform the following steps.

Press the OPTION MENU  Option Menu function key.

Use the UP/DOWN   arrow keys to select Menu Option 1: MODIFY DIAL/RING.

The Model 930A display will appear as follows:

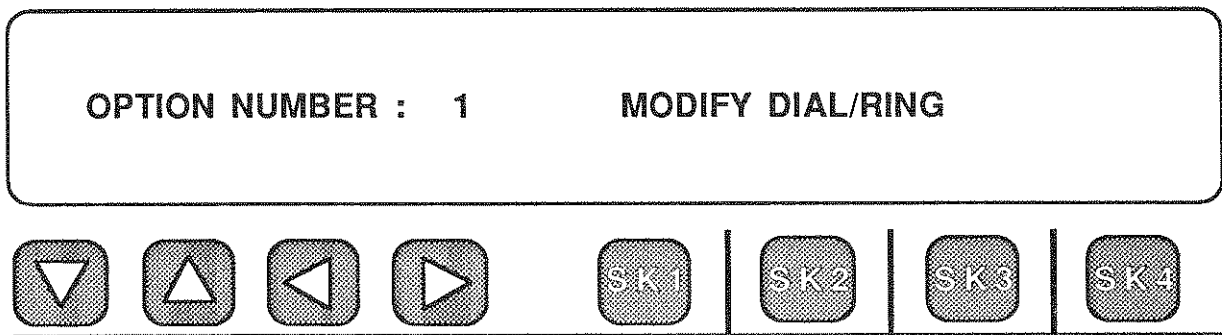

Press any softkey to enter the function.

NOTE: Entering a 1 and pressing the **ENTER** key will cause the 930A to go directly to Menu Option 1 and enter it.

Once you have entered the function, there will be one of two possible displays shown. For **MF** or **DTMF** the display is the same. Only the display for **DP** is different. The following sections will describe how to modify the different types. This section will consider only the modification of outpulsed digits which is a standard feature.

5-1.2 CHANGING THE LEVEL, FREQUENCY AND TIMING OF MF OR DTMF DIGITS

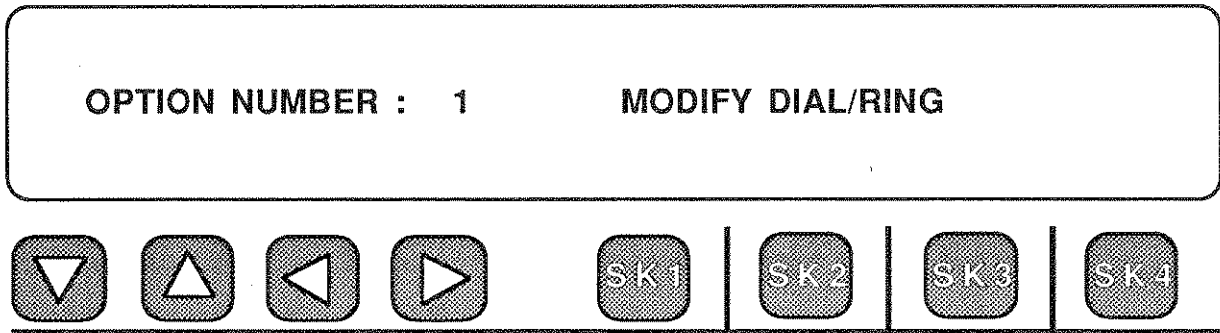

Press any softkey to enter the function.

NOTE: Entering a 1 and pressing the **ENTER** key will cause the 930A to go directly to Menu Option 1 and enter it.

Once you have entered the function, there will be one of two possible displays shown. For **MF** or **DTMF** the display is the same. Only the display for **DP** is different. The following sections will describe how to modify the different types. This section will consider only the modification of outpulsed digits which is a standard feature. The Ring Generator is purchased Option 930A-13.

After selecting the **MF** or **DTMF** mode under **DIAL/RING**, the **MODIFY SEND DIGITS** display would be:

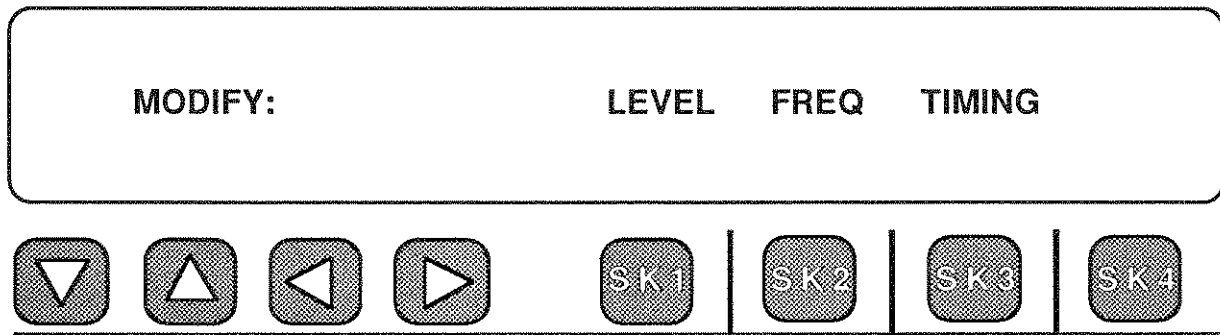

Use **Softkey 1** to inspect or modify the tone levels.
Use **Softkey 2** to inspect or modify the tone frequencies.
Use **Softkey 3** to inspect or modify the timing.

To change the output level of the digits, press Softkey 1 (under LEVEL) to bring up the following display:

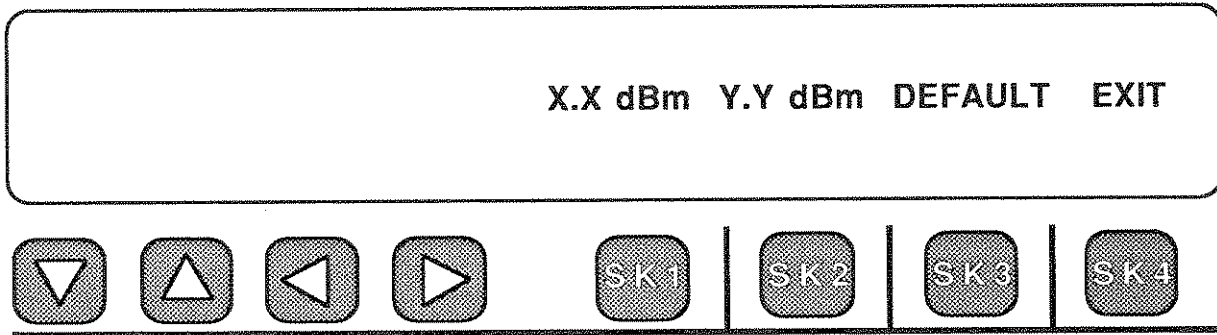

where X.X and Y.Y are the levels at which the low tone and high tone, respectively, are being sent. Typically these are 0.0, -7.0 or -23.0 dBm (7 dB below the TLP as a default) depending upon Trunk Type selected.

- Softkey 1 selects the **LOW** tone level to be modified.
- Softkey 2 selects the **HIGH** tone level to be modified.
- Enter another level using the Numeric Keypad.
- Softkey 3 selects the **DEFAULT** levels.
- Softkey 4 will return you to the main selection display.

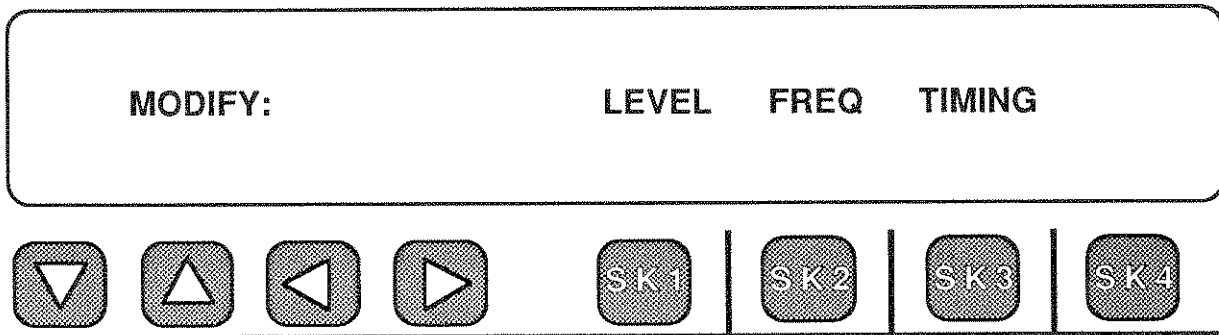

To change the frequencies of the digits being sent, press Softkey 2 (under FREQ):

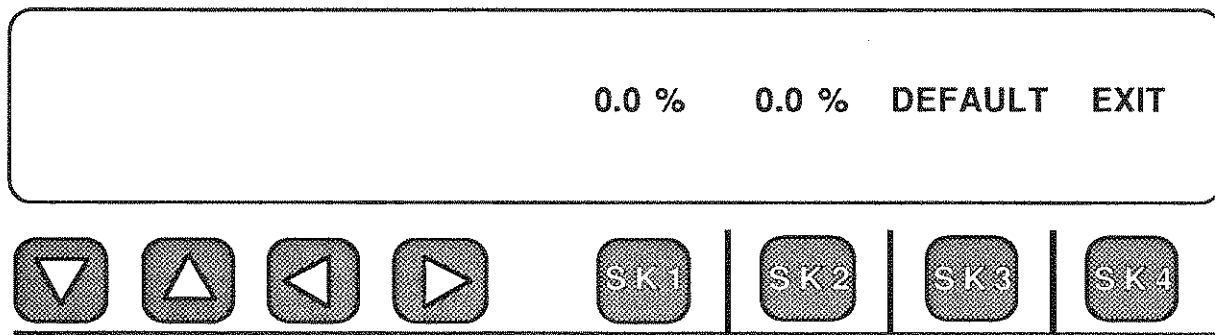

0.0% is the default, indicating no change in tone frequencies.

Softkey 1 (LOW Tone) and 2 (HIGH Tone) select which tone frequency is to be modified.

Press one or the other, enter the percentage (either + or -) from the keypad, and press **ENTER**. Typical values might be +/- 2%.

Softkey 3 selects the **DEFAULT** or unmodified values.

Softkey 4 returns you to the "MODIFY" display.

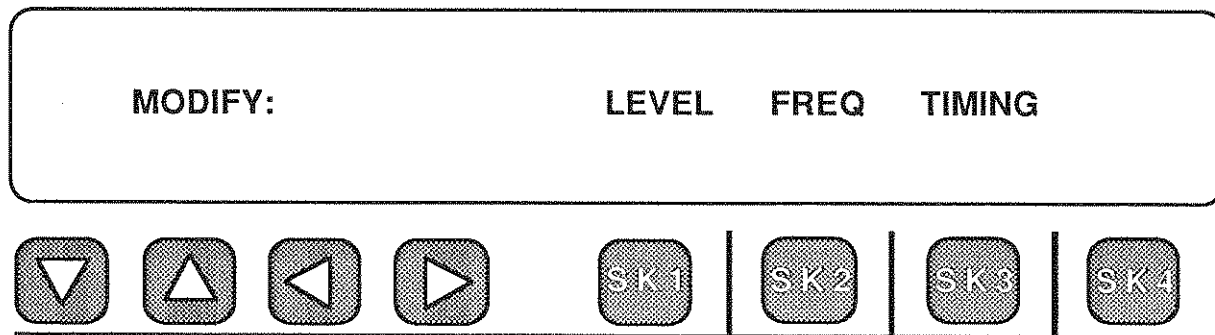

To change the timing of the digits you are outputting, press Softkey 3 (under **TIMING**):

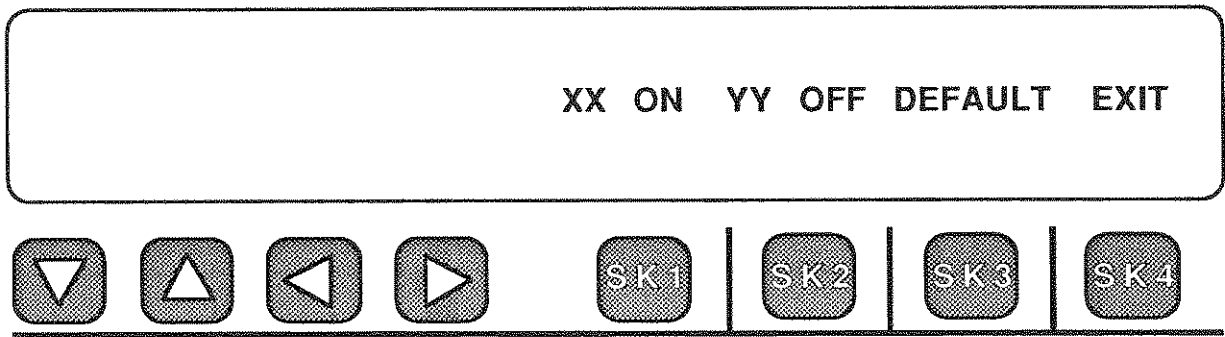

XX is the number of milliseconds the tones are **ON** and **YY** is the Interdigit time (time between tones) in milliseconds. These are typically 50 milliseconds **ON** and **OFF** for **DTMF** and **70** milliseconds for **MF**.

Softkeys 1 and 2 select whether On or Off time is to be modified. Then you enter the desired time from the keypad.

Softkey 3 enters the **DEFAULT** values. These will vary depending upon whether **MF** or **DTMF** has been selected.

Softkey 4 will return you to the **MODIFY** display.

Pressing any function key will exit to that function, causing the modifications to be retained in non-volatile memory. In the **DIAL/RING** function, any sequence of digits which is outputted will be sent with the modifications you set in the **MODIFY DIAL/RING** menu.

5-1.3 HOW TO CHANGE % BREAK, RATE AND INTERDIGIT TIME OF DIAL PULSE (DP) DIGITS

After selecting **DP** digits under the **DIAL/RING** function, a different **MODIFY SEND DIGITS** display will be presented when you enter Option Number 1.

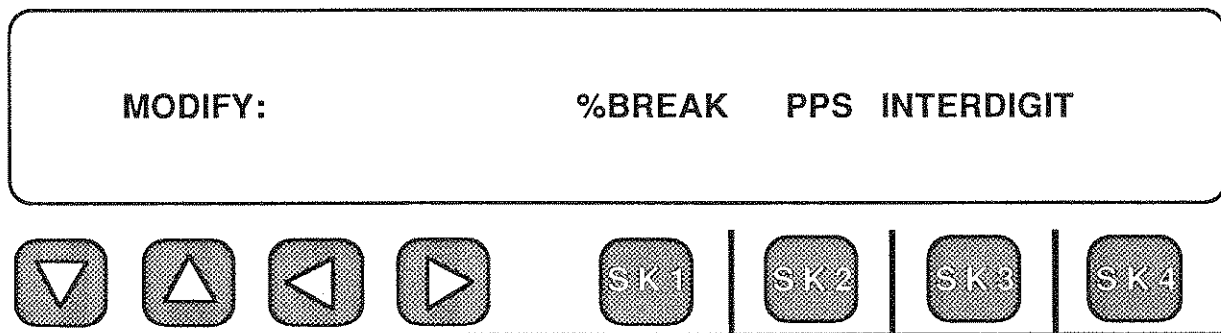

Softkey 1 lets you change the On Hook percentage of the pulse.

Softkey 2 lets you change the number of pulses per second.

Softkey 3 lets you change the Interdigit timing.

You can press any function key to exit.

To change the **% BREAK**, press Softkey 1 (under **%BREAK**):

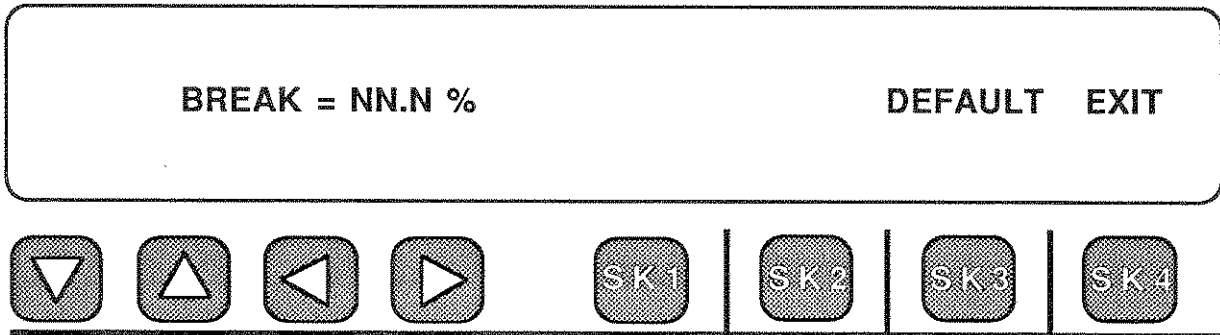

NN.N is the **ON HOOK** percentage of each pulse (default is 60.0%).

Enter the percentage you want from the keypad.

Press **Softkey 3** to reset the % to the 60.0% **DEFAULT** when you are finished testing.

Press **Softkey 4** to **exit** back to the main menu display.

To change the **Dialing Speed**, press Softkey 2 (under **PPS**):

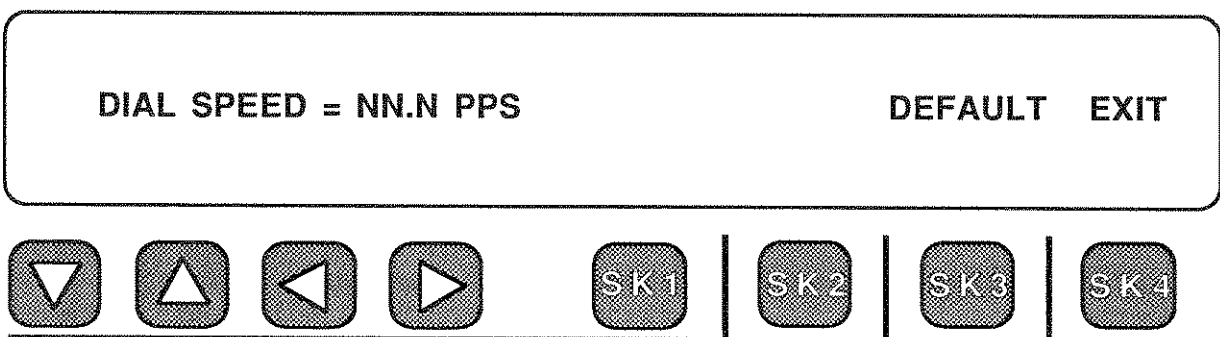

NN.N is the number of pulses per second.

Change the dial speed using the keypad to enter a new value.

Press **Softkey 3** to change back to the 10 PPS default after you are finished with the test.

Press **Softkey 4** to exit back to the main menu.

To change the **INTERDIGIT TIME**, press Softkey 3 (under **INTERDIGIT**):

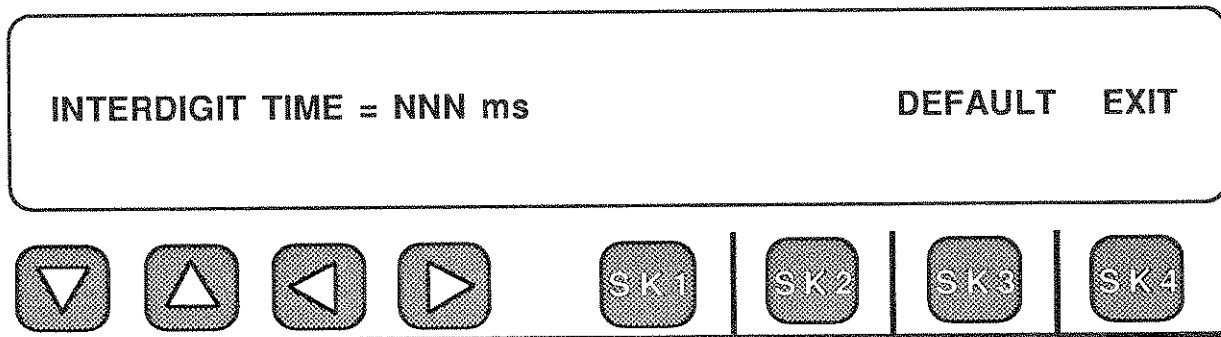

NNN is the number of milliseconds between digits.

Change the Interdigit Time using the keypad to enter a new value.

Press **Softkey 3** to change back to the 700 msec. **DEFAULT**.

Press **Softkey 4** to exit back to the main menu.

5-1.4 MODIFICATION OF RING GENERATOR PARAMETERS

Select **DIAL/RING**. While in the Dial/Ring Mode, Select Menu Option 1 Modify Dial/Ring. The following screen is displayed:

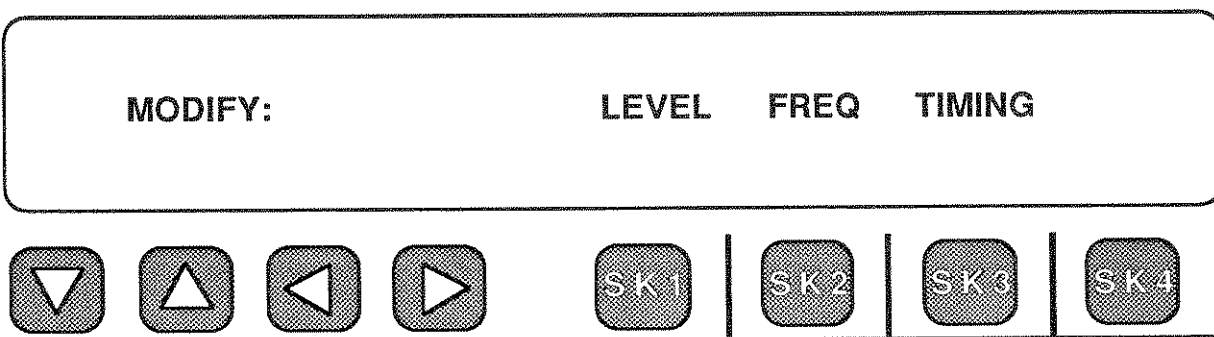

Press **Softkey 1** to inspect or modify **Ringer level**

Press **Softkey 2** to inspect or modify **Ringer frequency**

Press **Softkey 3** to inspect or modify **Ringer On/Off time**.

Press the **OPTION MENU** function key to exit the menu.

Pressing **Softkey 1** under level will bring up the following display:

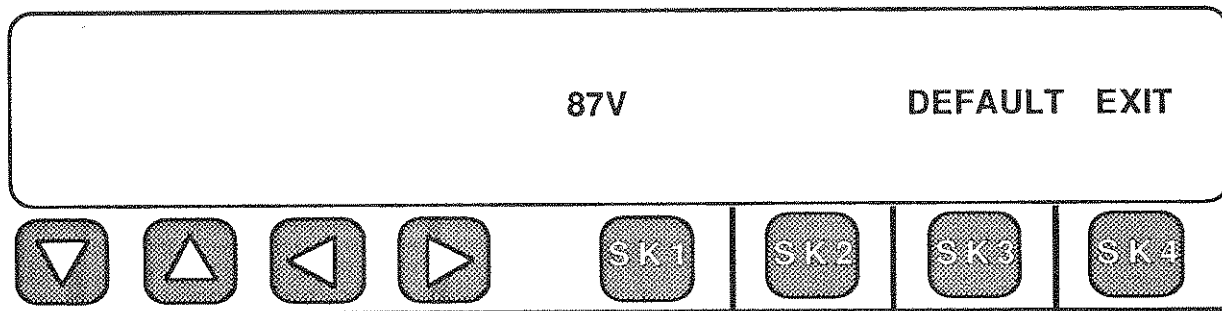

To change the voltage, enter the new value using the keypad. Press enter. The new value will be displayed. To change frequency, press **SK2 FREQ** at top menu. The following screen will be displayed:

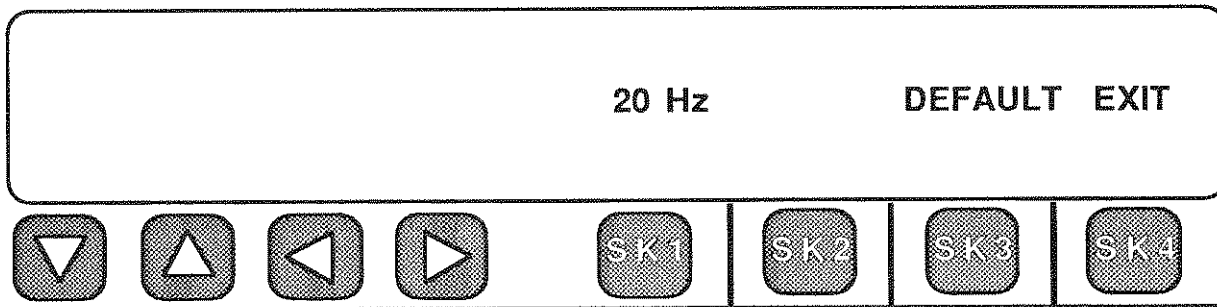

To change the Frequency, enter the new value using the keypad. Press enter. The new value will be displayed. To change the On/Off Ringer interval, press **SK3 TIMING**. The following display will be displayed:

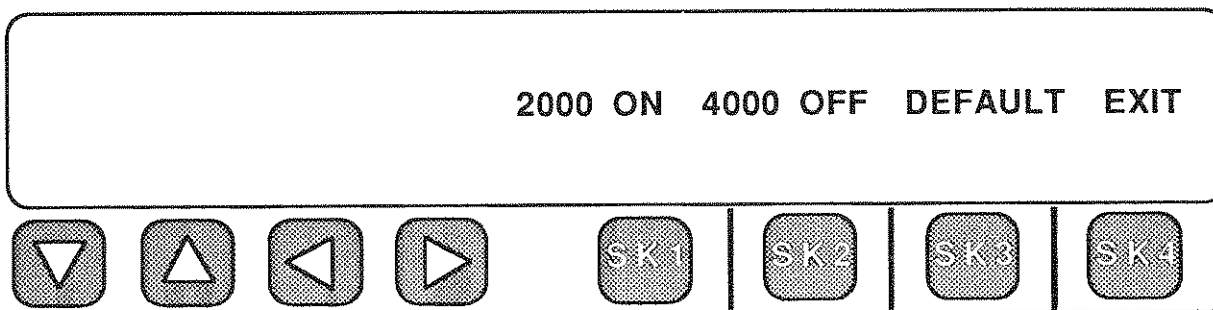

To change the Ring interval, enter the new value using the keypad. Press enter. The new value will be displayed. Select **SK1** for On time and **SK2** for Off time. Press **EXIT** when complete.

5-2 HOW TO BUILD A CALL SEQUENCE (MENU OPTION 2)

There will be times when you will want to send more than one phone number in sequence (Feature Group D, TSPS, etc.), or send a very long string of digits (up to 72 digits long), or continuously send a sequence of digits over and over.

Menu Option Number 2: **SEND DIGIT SEQUENCES** is the function which allows you to do these things. It operates in conjunction with the **DIAL/RING** function and the **STORE** function.

The procedure starts with entering the telephone numbers you want to send one at a time in the **DIAL/RING** function. You store each of these strings (for example 4087611000, 5551212, etc.) one at a time in any of the 39 registers (01 to 39). You then select Option Number 2, enter the menu, and input the storage location numbers instead of the phone numbers. This sounds a bit complicated but it is really easy once you have gone through the steps, or have seen it done.

Rather than go through details it is better to look at some examples. The following examples will show you how to send a multi-wink sequence such as a Feature Group D, how to send a simple wink start sequence, and how to send up to a 72 digit long string.

5-2.1 HOW TO BUILD A FEATURE GROUP D SEQUENCE IN THE 930A

To build a Feature Group D (Equal Access) call from a Bell Operating Company (BOC) switch to an Interconnect Carrier (IC) through an Access Tandem switch, do the following:

Press the DIAL/RING



 Dial/Ring function key.

If no sequence has previously been entered, the display will come up blank. Normally, the last number dialed will be showing. Before beginning any data entry you should press the **CLEAR** key to remove any existing sequence from the display.

If there is no other sequence displayed, or after you have pressed the **CLEAR** key, you will see the display below.

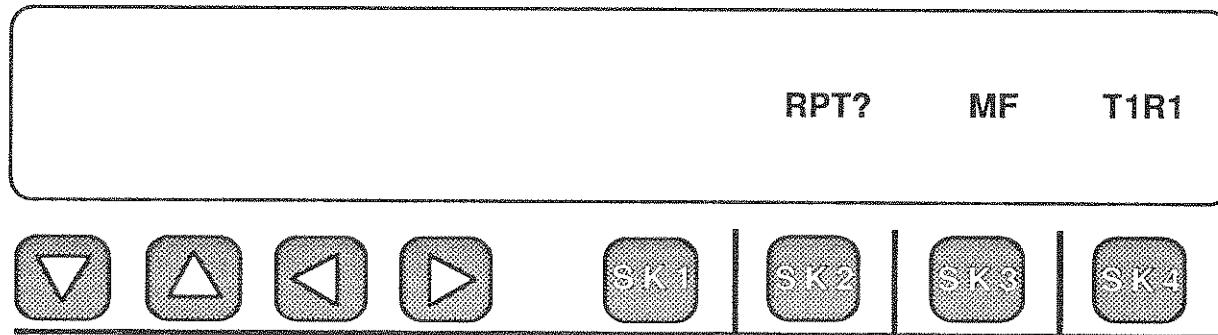

If you do not come up into **MF** digits when you enter **DIAL/RING**, press Softkey 3 until **MF** is displayed.

Basically, there are two types of equal access sequences. The 3-stage sequence is found on the input side to the Access Tandem. The 2-stage is found on the output from the Access Tandem toward the Interconnect Carrier. Both are Wink Start trunk calls and the only difference is that the 3-stage includes the Interconnect Carrier's identity code in addition to the calling number (**ANI**) and the called number.

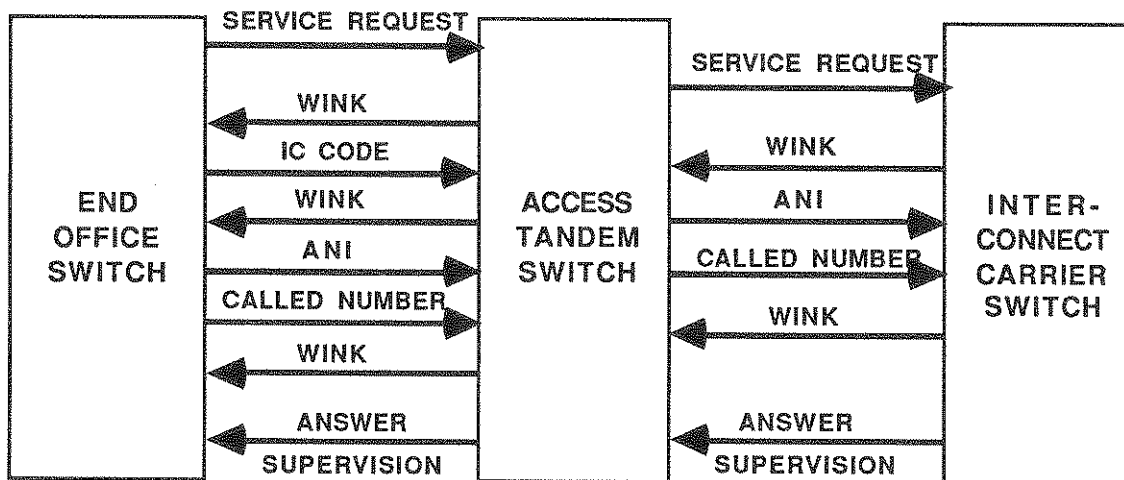

EQUAL ACCESS CALL PROGRESSION DIAGRAM

The 3-stage call has the form:

WINK IC CODE WINK CALLING # CALLED # WINK

The 2-stage call has the form:

WINK CALLING # CALLED # WINK

To simulate these calls, enter the numbers to be dialed and store them sequentially into memory. Starting from a blank display, the process is:

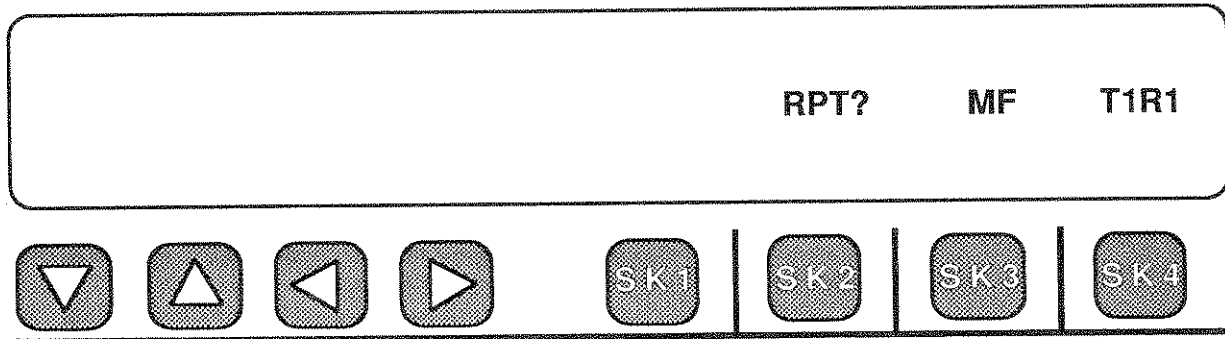

For this example, we will simulate a full Feature Group D call sequence using the number "KP001777ST" for the IC code, "KP004087611000ST" for the calling number (ANI), and "KP4155551212ST" for the called number. Each must be entered and stored separately. The procedure is outlined on the following pages.

Use the Numeric Keypad to enter the IC code, which, for example purposes, is assumed to be



"KP001777ST", in MF. That is, press **KP ***, then press **0** twice, then press **1**, then **7** three times, and finally press **ST #**.

This is only an example of an IC code. You must check the local codes in effect for your area when doing this for real.

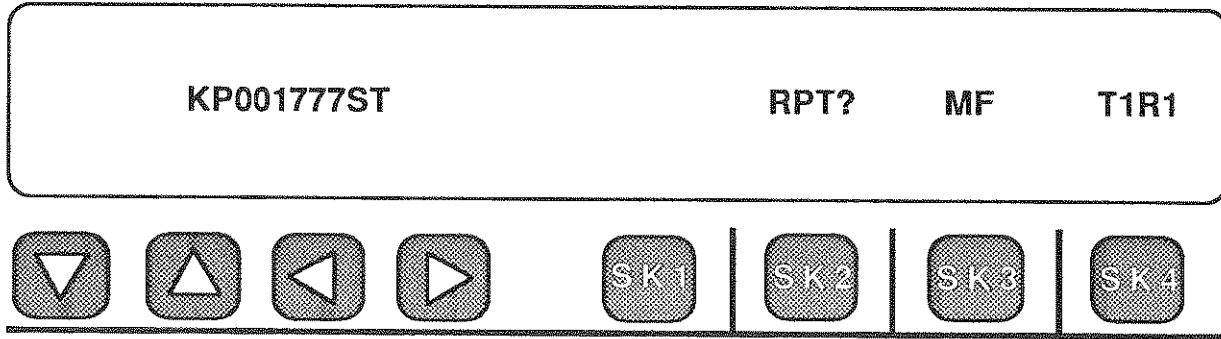
The IC code example display is:



Store this sequence in location 10, for example



by pressing the    and

 keys.



Press the CLEAR  key to clear the display and allow entry of the next sequence.

The next step in creating the Equal Access call is to enter the calling number. The **MF** string for the **ANI** is "KP004087611000ST" in this example. The first two digits are the information digit pair (for inter-LATA restricted lines), and then the 10 digit **ANI** number (calling number plus area code). The **MF** delimiters "KP" and "ST" surround the number.

Use the keypad to enter the number as follows:

Press  , then press  twice, then

press     

     and

finally, press .

When you have correctly entered the ANI, the display will look like:

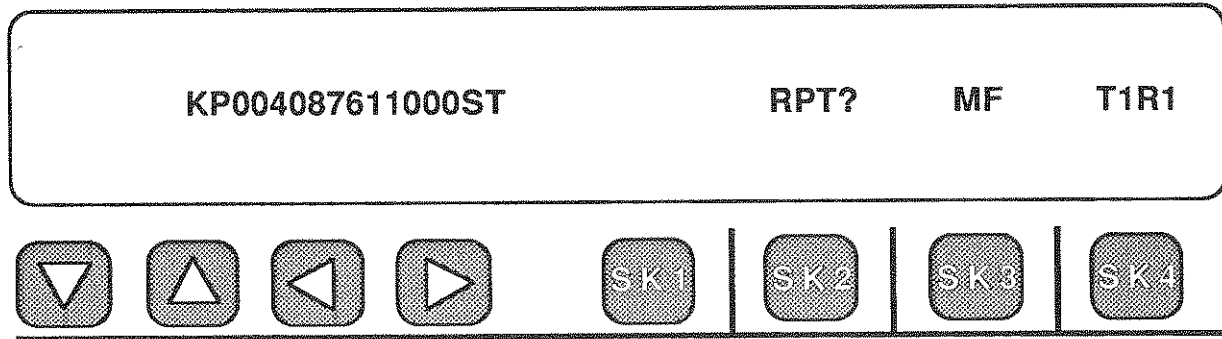

Store this sequence in location 11 by pressing the **STO** and **ENT** keys. Notice that the 930A automatically incremented the register location so that it was not necessary to enter the number 11.

Press the **CLEAR CLR** key to clear the display and allow entry of the next sequence.

After you have entered the **IC code** and the **ANI** into memory locations 10 and 11 respectively, all you have left is the **called number**.



The final string is the called number (with Area Code). For this example, we used the number "4155551212." In **MF**, this number is surrounded by the **KP** and **ST** delimiters, so we enter it as follows:

Press **KP***, then press **4** **1** then
press **5** four times, then **1** **2**
1 **2** and finally, press **ST#**.

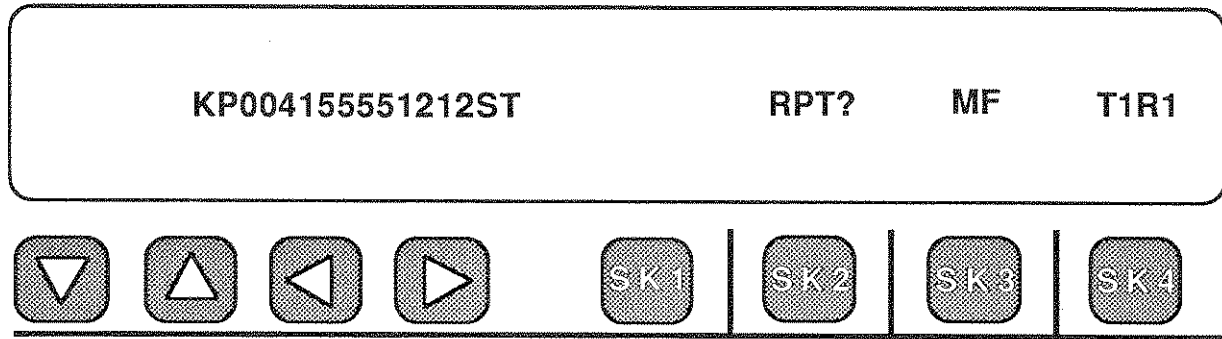
When you have correctly entered the called number, the display will look like:





Store this sequence in location 12 by pressing

the  and  keys.

When you have entered and stored all the numbers, press the **OPTION MENU** key and go to Menu Option 2: **SEND DIGIT SEQUENCES**. To set this menu to send the Equal Access call, do the following:

Press the OPTION MENU   **Option Menu** function key.

Use the UP/DOWN   arrow keys to select Menu Option 2: **SEND DIGIT SEQUENCES**.

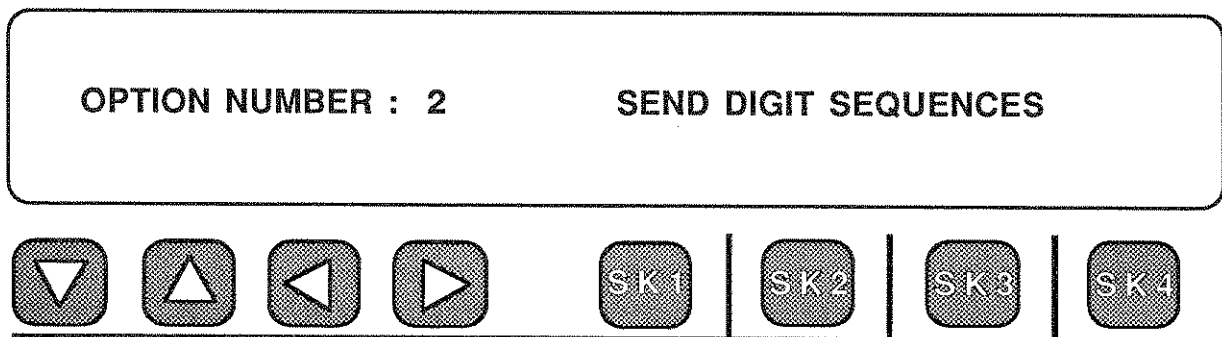

Press any softkey under the display to enter the menu:

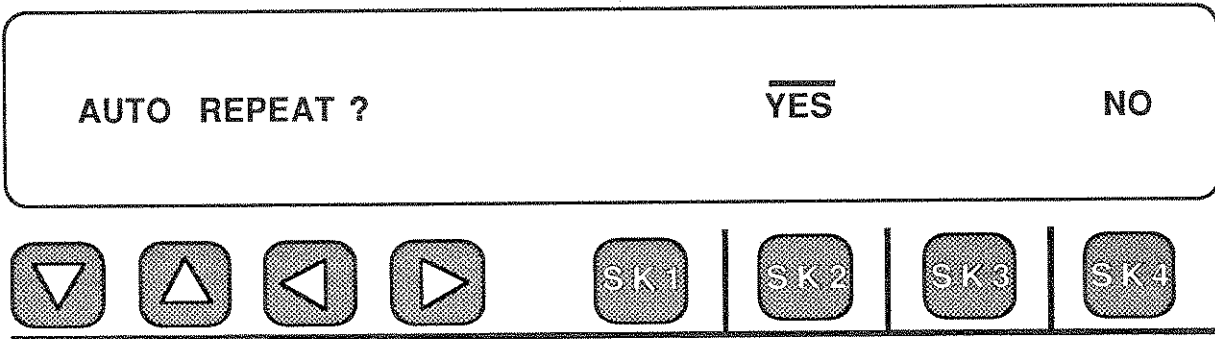

If you press Softkey 2 (under YES), the 930A will continuously repeat sending the sequence entered.

If you press Softkey 4 (under NO), the 930A will only send the sequence once. This is normally what most people want.

Whichever key you press, the 930A screen will become:

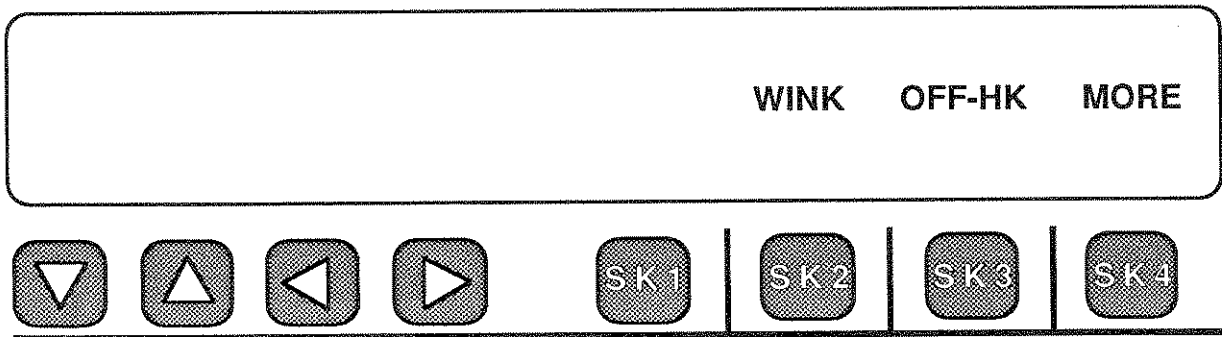

If a previous test sequence is present, press the CLEAR CLR key and the display will show:

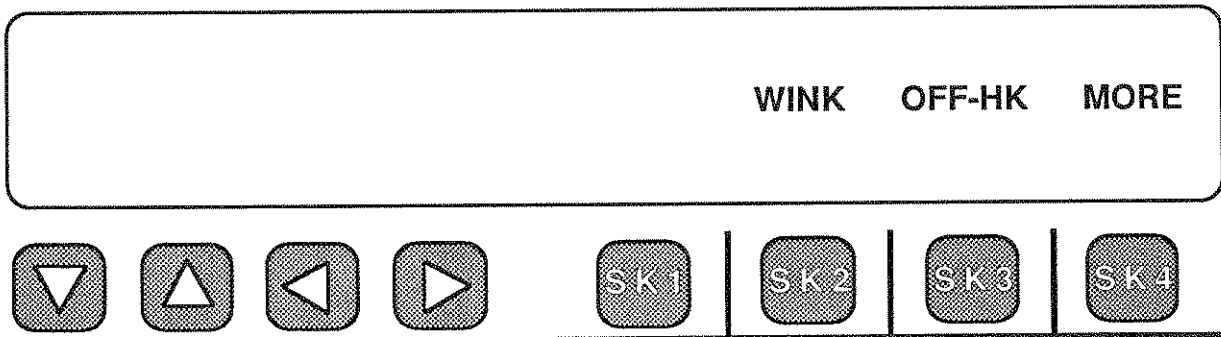

Remember, a Feature Group D input to an Access Tandem consists of the **IC Code** number, the **ANI** or calling number, and the **called number**, separated by Wink supervision at the appropriate points. To input the sequence into the above display, do the following:

Press Softkey 2 (under **WINK**) to instruct the 930A to wait for a Wink before outputting.

Press  and  and then 

This tells the 930A to send the IC code digits stored in register 10 after it sees the wink.

Press Softkey 2 again to tell the 930A to wait for another Wink between the IC Code number and the rest of the numbers. The 930A will then wait for the second Wink.

Press  twice and then 

Press  and  and then .

This instructs the 930A to output the **ANI** and **called number** stored in registers 11 and 12 respectively.

Press Softkey 2 to tell the 930A to look for the final Wink which completes the sequence.

Press Softkey 3 to tell the 930A to expect the far end to go "Offhook" when the call completes.

When you have correctly built the call sequence into the 930A, the display will look like:

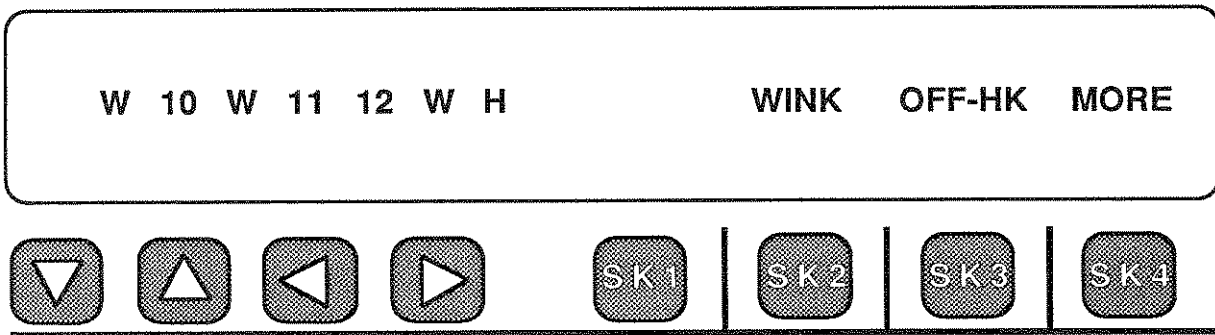

where **10** = KP001777ST, **11** = KP00408761000ST, and **12** = KP4155551212ST, in this example.

Look at the example display above and compare it to the form of the 3-stage call repeated below:

| | | | | | |
|-------------|----------------|-------------|------------------|-----------------|-------------|
| WINK | IC CODE | WINK | CALLING # | CALLED # | WINK |
| W | 10 | W | 11 | 12 | W |

To send the call sequence, go **OFF HOOK** using the front panel Hook-switch and the 930A will start sending when it gets a wink from the far end.

From this example you can see that it would be a very simple thing to change from the 3-stage to a 2-stage call at the output side of the Access Tandem. All you would have to do is clear out the old display and enter the new sequence with the IC code removed.

That is, the new sequence would be (Off-Hook supervision is left out):

| | | | |
|-------------|------------------|-----------------|-------------|
| WINK | CALLING # | CALLED # | WINK |
| W | 11 | 12 | W |

You can use any memory locations you want. The principles remain the same.

The **SEND DIGIT SEQUENCES** Menu Option has been designed specifically to outpulse from the register locations where the digit strings are stored.

If the 930A is already **OFFHOOK**, go back **ONHOOK** and then go **OFFHOOK** again and the sequence will be outpulsed. You will hear the outpulsing digit strings on the 930A's speaker and you should also hear the far-end answer. The Model 930A will also automatically time the winks. The wink timing can be examined by going to Menu Option 9: **WINK TIMING**.

You can either "send" a multi-wink sequence from the 930A or "receive" a multi-wink sequence but you cannot do both simultaneously from a single 930A. A single 930A cannot simulate the Originating and Terminating offices simultaneously.

NOTE:



Any modifications made in **MODIFY DIAL/RING** (Menu Option 1) will also be stored.

Make sure that the correct Trunk Type has been selected before storing any strings.

5-2.2 HOW TO PLACE A CALL ON A WINK START TRUNK

E&M or T1 Carrier Interoffice Trunks are commonly Wink Start trunks. That is, the originating office will not send digits to the terminating end until it receives a wink from the terminating end office indicating that it is all right to proceed.

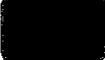
To examine the procedure for originating a Wink Start call, assume a **DTMF** sequence is to be sent. As in the previous example, it is necessary to first store the desired phone number in one of the memory locations (00 to 39) under the **DIAL/RING** function. To repeat the process:

Press the **DIAL/RING**   **Dial/Ring** function key.

The 930A display below is a typical example:

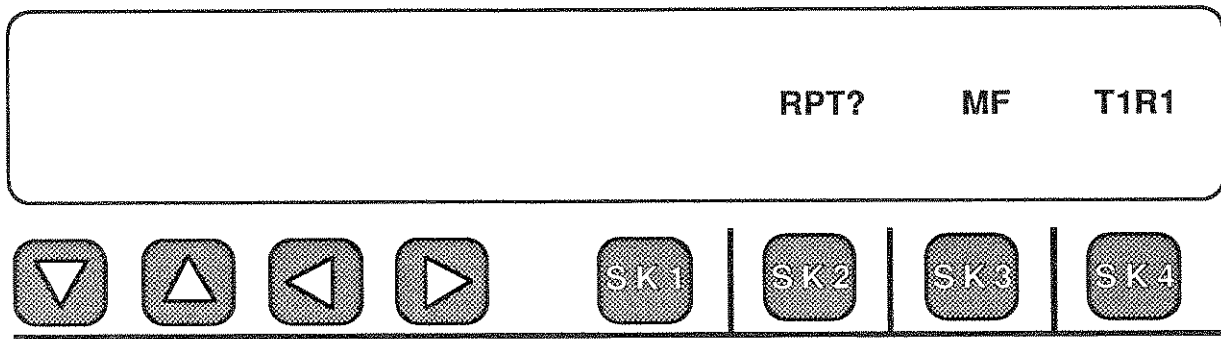

To send the **DTMF** digits called for in this example, press Softkey 3 (under **MF**) and the display will change to:

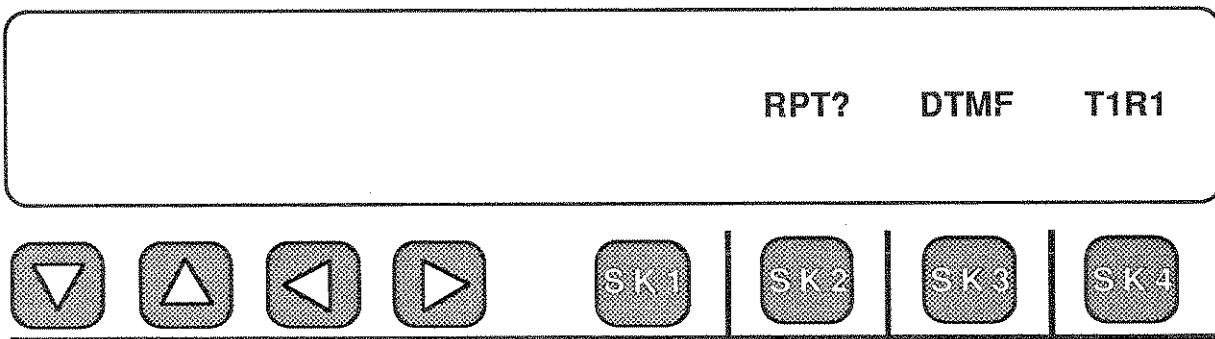

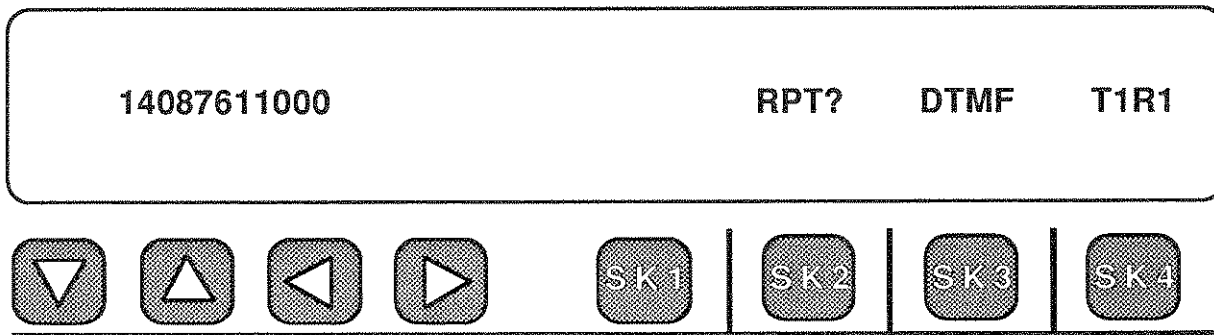

Next, enter the telephone number you want to call using the keypad like a regular telephone. Make sure that the 930A is **ON HOOK**. After entering a number, a typical display is:



You use the same procedure employed in the Feature Group D example to store the number in, say, register location **20**. After you press the **STORE** key, enter **2** and **0** from the keypad, and press the **ENTER** key. The 930A display will return to the above display. At that point, just perform the following steps:

Press the OPTION MENU   Option Menu function key.

Use the UP/DOWN   arrow keys to select Menu Option 2: SEND DIGIT SEQUENCES.

The 930A display should look like:

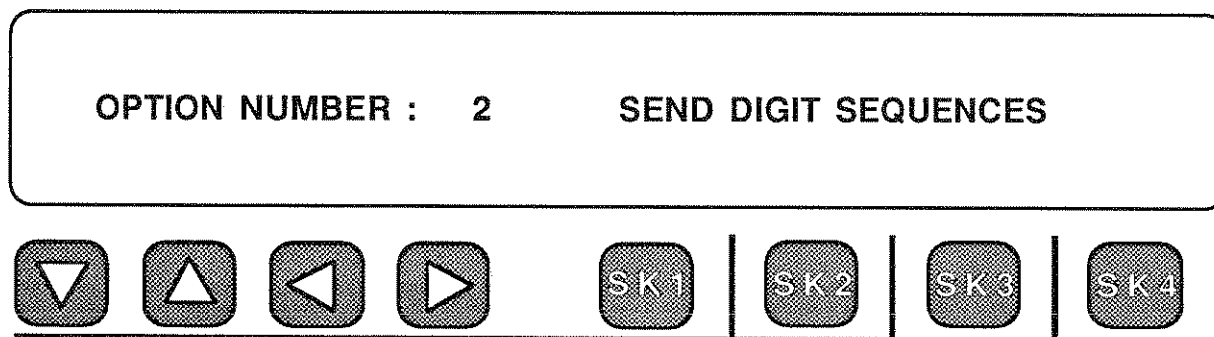

Press any softkey under the display to enter the Menu Option and the 930A display will change to:

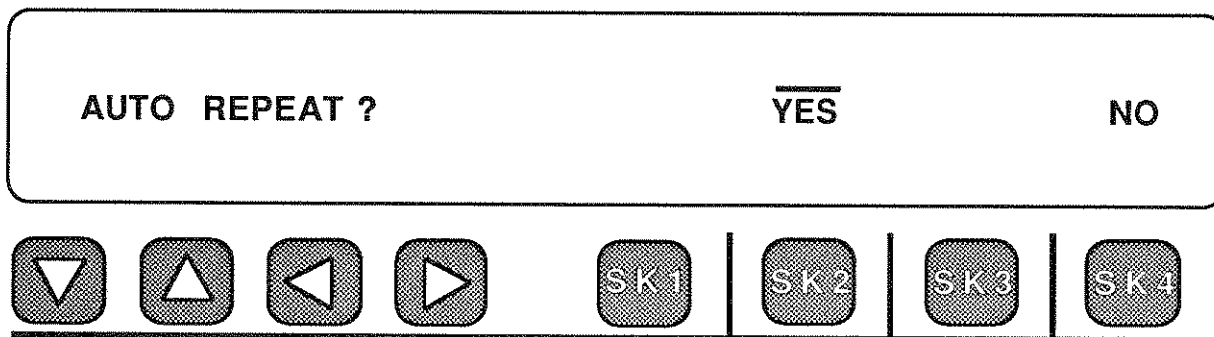

If you press Softkey 2 (under YES), the 930A will continuously repeat outputting the sequence after you go OFF HOOK.

If you press Softkey 4 (under NO), the 930A output pulses the sequence you enter once.

Pressing either softkey causes the 930A display to become:

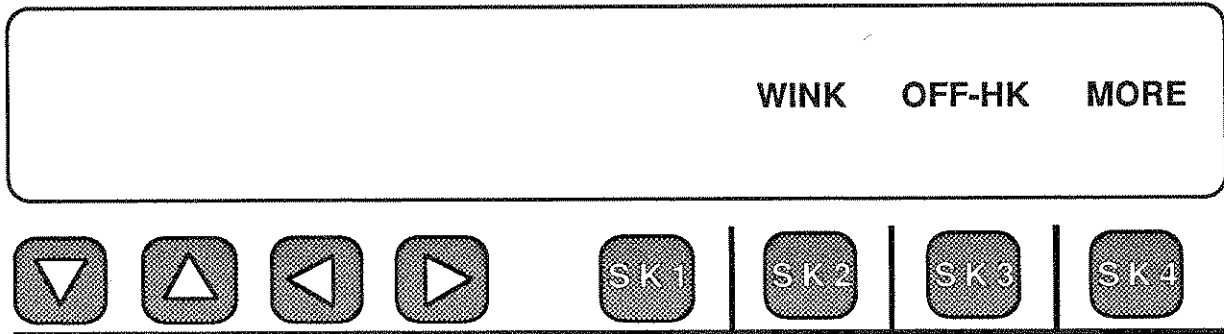

To program the 930A to wait for a wink before outputting, press Softkey 2 (under **WINK**) and the 930A display will become:

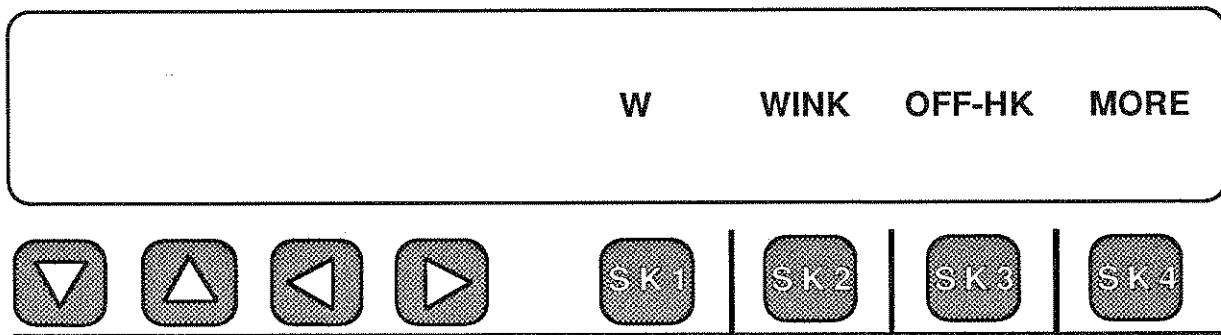

Next, enter the location of the memory register where the phone number to be outputted is located. In this example, the number to be outputted after the wink, was stored in memory location **20**. Press **2** and **0** on the numeric keypad, then press the **ENTER** key, and the 930A display will be:

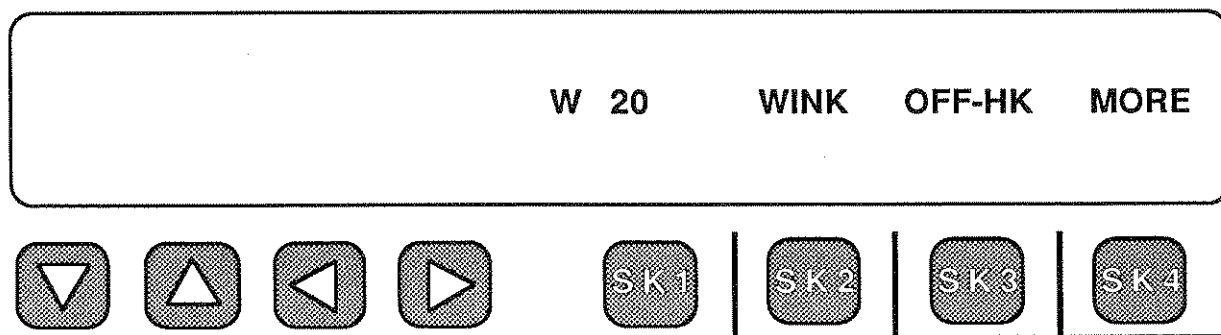

An **OFF HOOK** indication can be inserted at the end of the sequence to look at answer back supervision. Press Softkey 3 (under **OFF-HK**) and the display will change to:

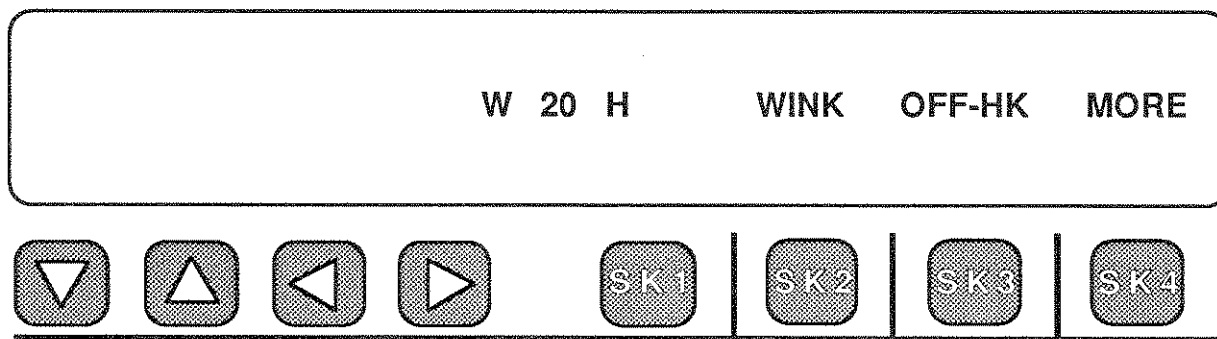

To outpulse the telephone number then, all that is required is to place the front panel hook switch in the **OFF HOOK** position and the 930A will seize the trunk, wait for a wink and then outpulse the digits after the wink.

5-2.3 HOW TO SEND A CALL MORE THAN 18 DIGITS LONG

You may want to send a phone number longer than the 18 digit maximum permitted by the **DIAL/RING** function.

Suppose you want to send out a long string of digits as part of your manufacturing tests on a piece of your equipment. First, you enter the number under **DIAL/RING**, then you store it in one of the 40 register locations, then you go to Menu Option 2 and enter the storage location, and finally you go Offhook.

This situation is a little different because we cannot enter the entire number into the **DIAL/RING** display.

Suppose you want to send a string of thirty **DTMF** 6's. We know we can send 18 digits from **DIAL/RING**. Go to **DIAL/RING**, select **DTMF** mode, and enter eighteen 6's. Then store this string in register 1. Next, clear out this display and enter twelve 6's and store them in register 2. These could have been any mixture of numbers.

Go to the **SEND DIGIT SEQUENCES** menu and clear out any previous sequences. Then enter the number 1, press **ENTER**, enter the number 2, press **ENTER**, and the display will be:

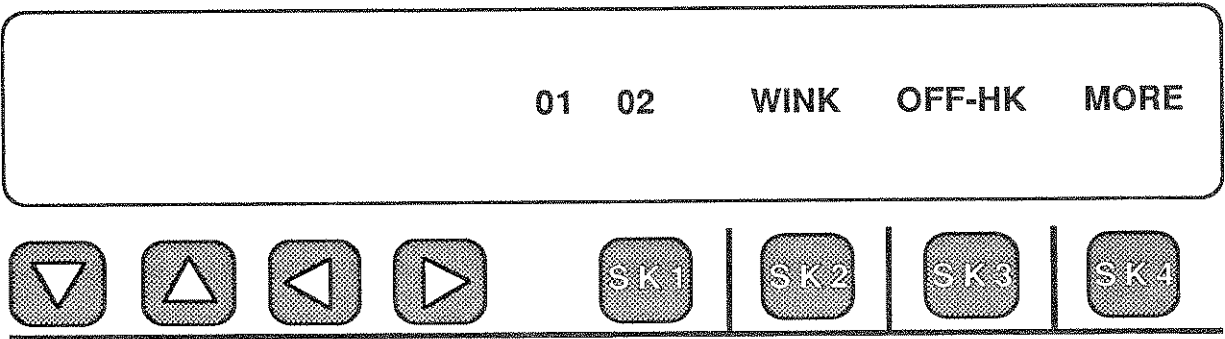

Now, go **OFF HOOK** and the 930A will send the string of thirty **DTMF 6's**. From this, you can see that all you have to do to send up to 72 digits, is to store up to 18 digits in each of four successive memories (1, 2, 3 and 4) . You can also use this menu to send a mixture of **MF, DTMF or DP** digits.

5-2.4 ADDITIONAL FEATURES OF MENU OPTION 2

By now, you are probably curious about what is under Softkey 4 (**MORE**) in these displays.

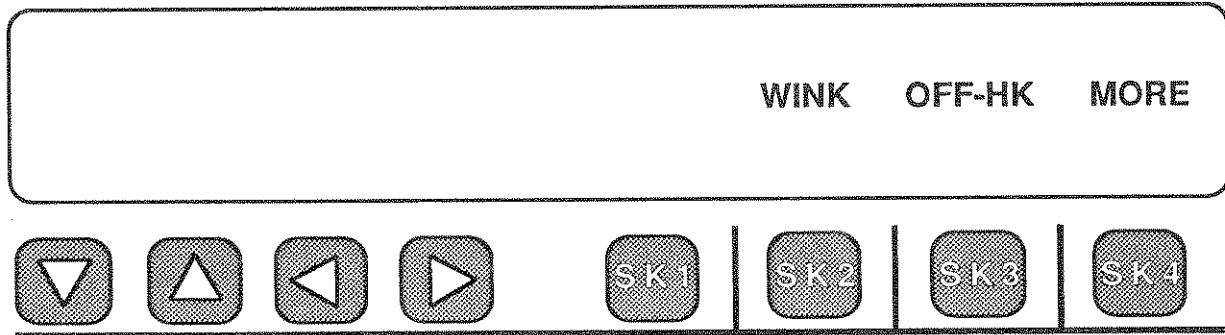

Instead of entering a **WINK**, or looking for an **OFF HOOK** at the end of the sequence, suppose you wanted to enter a pause. In this case, go back to the 930A display below:

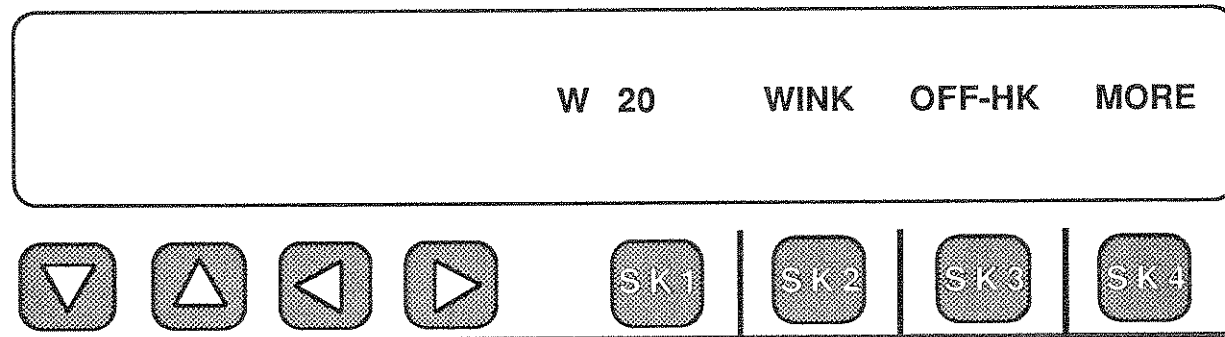

Instead of pressing Softkey 3, press Softkey 4 (under **MORE**) and the 930A display will advance to:

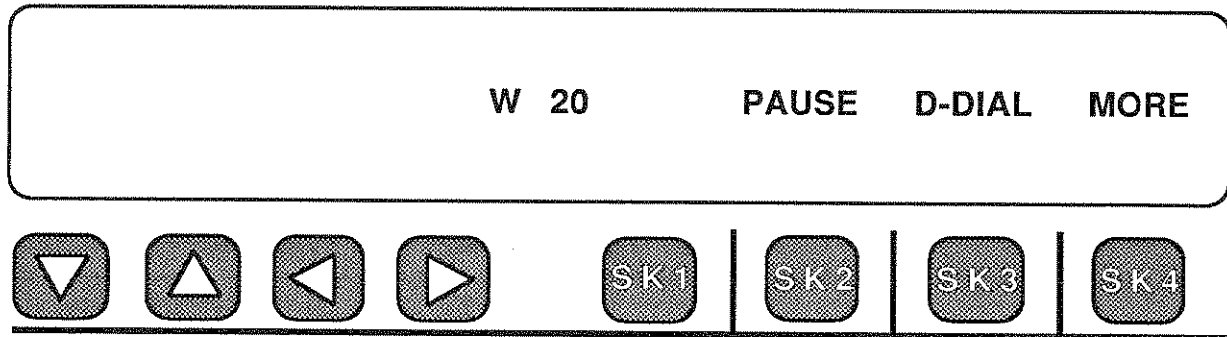

From this menu you can enter the Pause by pressing Softkey 2 (under **PAUSE**) and the 930A display will become:

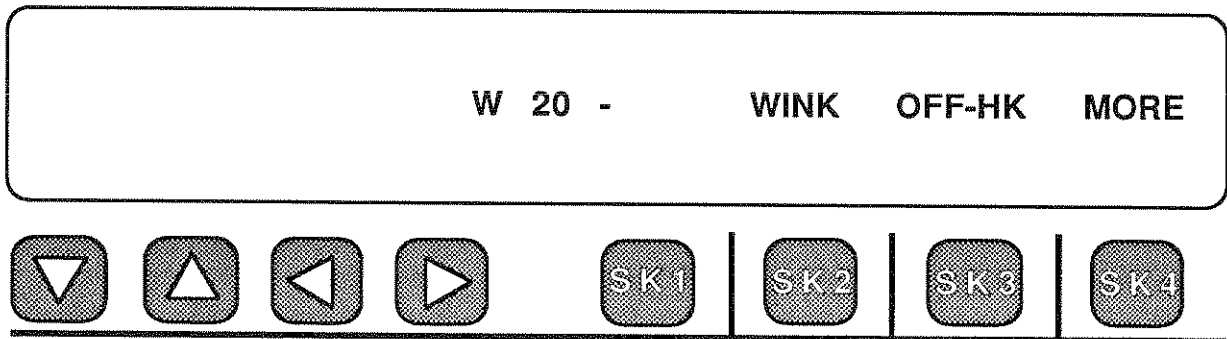

The digits stored in location **20** would be sent after going Off-Hook and receiving a wink. The 930A would then pause for one second after outputting.

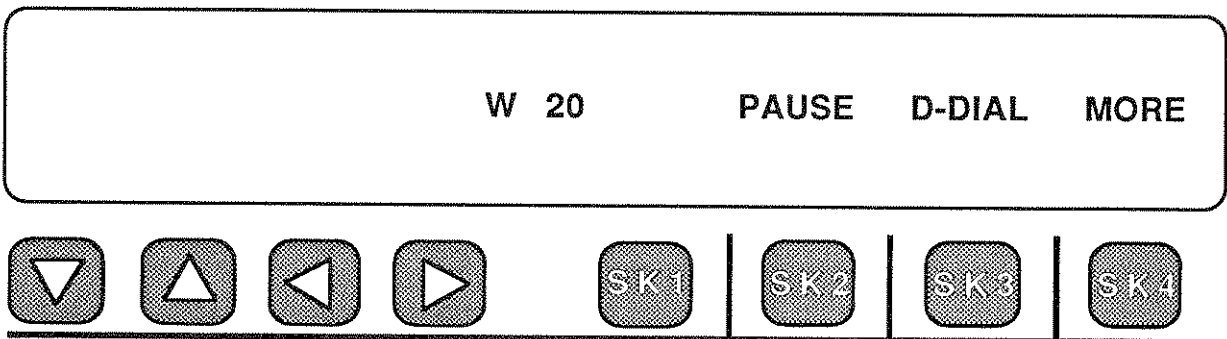

Instead of entering a **PAUSE**, a **DELAY-DIAL** event could be inserted by pressing Softkey 3.

Pressing Softkey 4 (under **MORE**) again, instead of entering a pause or delay-dial, would bring up the following choices:

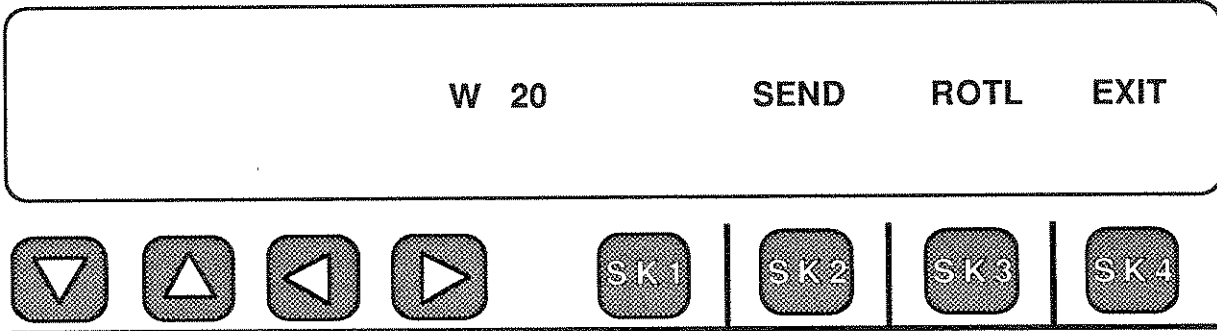

Pressing **Softkey 2** (under **SEND**) enables sending the sequence without first going **OFF HOOK**. Pressing **Softkey 3** (under **ROTL**) causes the 930A to act as a Remote Office Test Line (ROTL)/Near End Responder at the end of the sequence. Purchased Options 930A-01 and -12 are required for this to function. The display in this case looks like:

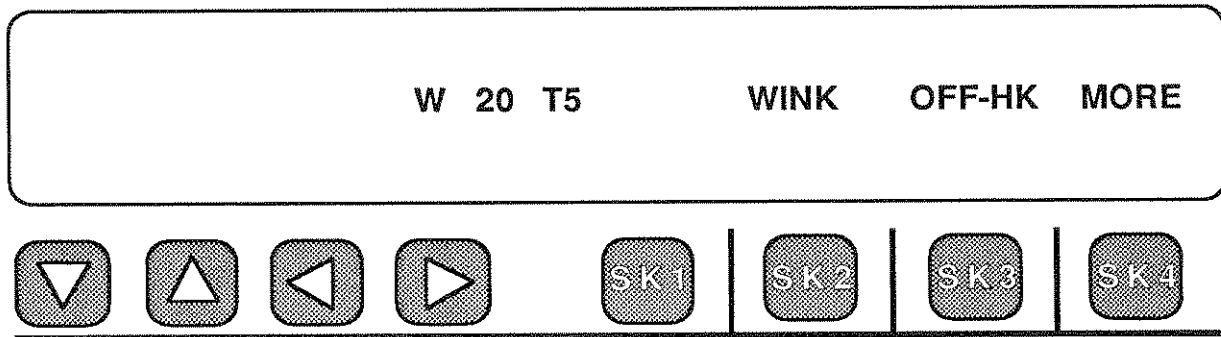

When the 930A goes **OFF-HOOK**, the number of the far-end test line will be outpulsed after the Wink is received. When the call completes, and the Test Line answers with the Test Progress Tones, the 930A will begin testing. The results of the 2-way measurements will be displayed. The results are stored in memory and you can review them in Menu Option 26.

5-2.5 ROTL/RESPONDER TESTING USING SEND DIGIT SEQUENCES

Option 930A-12 also enables you to operate the manual ROTL test function from **SEND DIGIT SEQUENCES**, Menu Option 2. This enables you to insert Winks or even place a Multi-Wink type call to initiate ROTL testing.

First, set up the **ROTL/RESPONDER** in Menu Option 26 as described in 5-26. This selects the TLP and tests which are desired. When this has been accomplished, you have the choice of sending the Far End Responders number from the **ROTL/RESPONDER** (Menu Option 26) or going to **Menu Option 2: SEND DIGIT SEQUENCES** to send it. In some cases, there are points in the telephone network where it is essential to be able to send a Multi-Wink sequence in order to complete a call. In such instances, you would place the call to the Far-End Responder from the **SEND DIGIT SEQUENCES** menu. Begin at Menu Option 2: **SEND DIGIT SEQUENCES**.

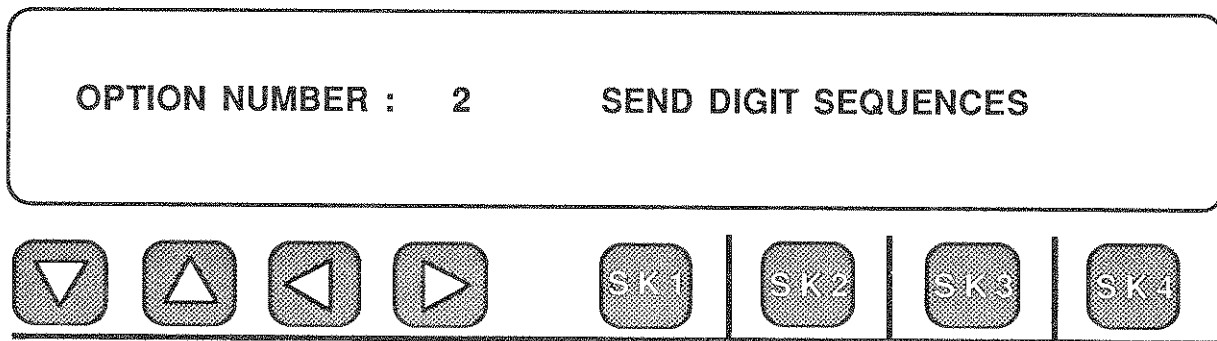

Enter the menu by pressing any softkey under the display and it becomes:

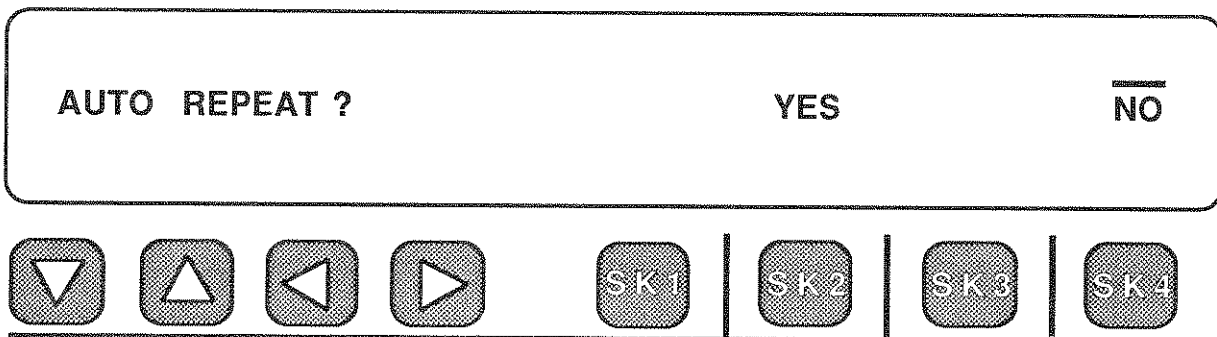

Press Softkey 4 (under **NO**) to send the call sequence once and the display changes to:

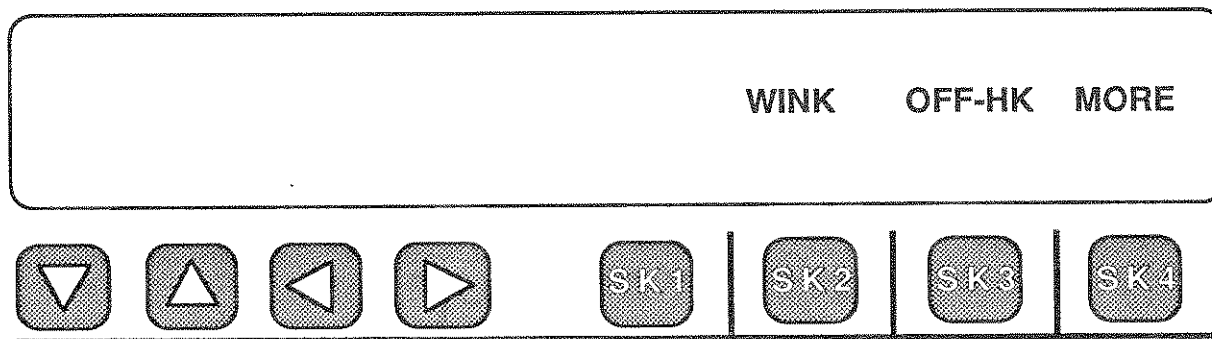

If any previously entered sequences are displayed, press the **CLEAR** key to obtain the above display.

As an example, simulate an Equal Access call sequence. This sequence will consist of two **MF** records: the **ANI** or calling number, and the **called number** which will be the test line's number. These two numbers will be stored in memory locations 15 and 16. After the winks and the two numbers have been correctly entered, the 930A display will look like the one below:

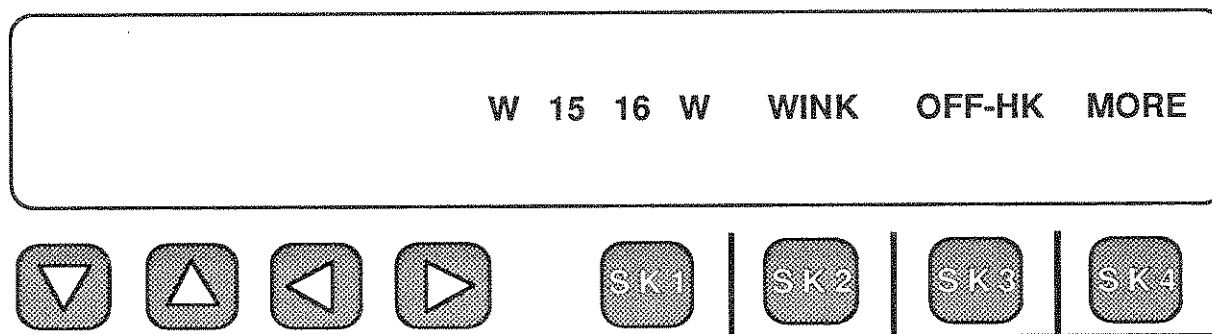

After entering the **Feature Group D** call sequence, the next step is to tell the 930A to become a manual **ROTL/Near-end Responder** so that it will commence testing after the call completes.

Press **Softkey 4** (under **MORE**) until the 930A display is identical to:

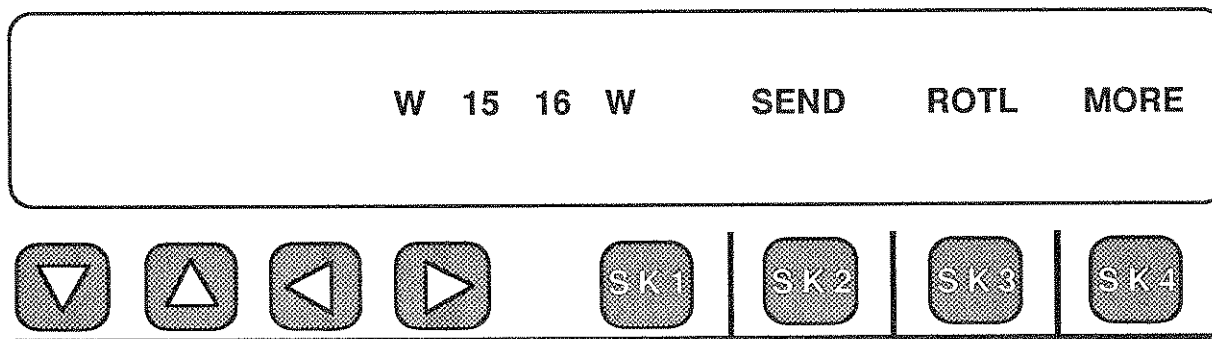

You will need to place the **ROTL** function at the end of the sequence by pressing Softkey 3 (under **ROTL**). The 930A display will become:

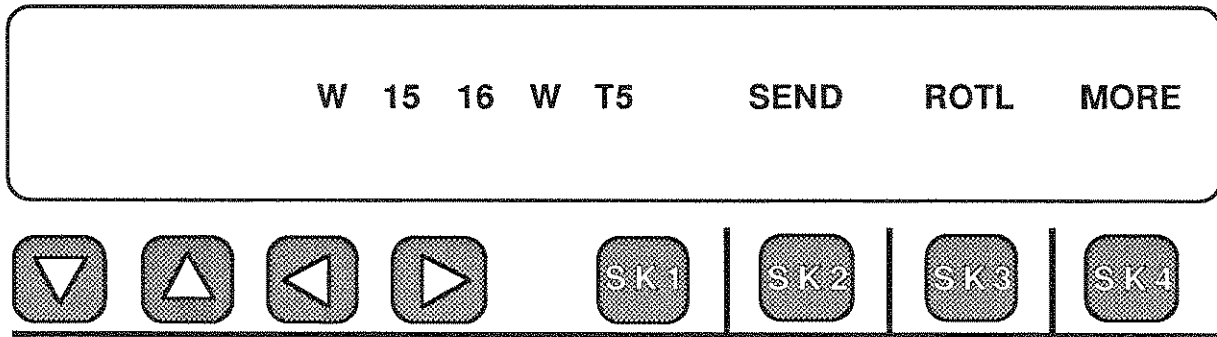

To begin testing, place the front panel Hookswitch in the **OFFHOOK** position and the 930A will output the call. The 930A display will appear as follows until the call completes and testing begins:

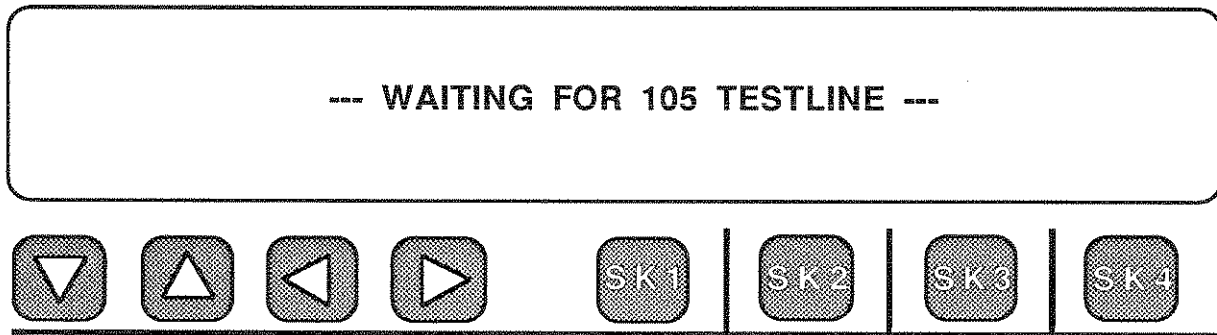









When testing commences, the two way test results will begin to appear.

5-3 PRINTER SETUP (MENU OPTION 3)









The procedure for setting up the 930A to work with a serial printer is similar to the procedure for setting up any of the remote operating modes. For this reason a brief review of the general set-up procedure follows:

- 1) Turn on the 930A, set-up the correct Trunk Type. (Section 3), and any test functions desired (Refer to Section 3).
- 2) Press the **OPTION MENU** key, page to Menu Option 3 (Remote Control), and set the mode to "**OFF**" (Refer to Section VI as necessary). Exit back to the main Option Menu by pressing Softkey 4 (under **EXIT**). This step prevents inadvertent dumping of data to the printer and filling up its buffer before you are ready to print.
- 3) Turn on the Printer and connect its cable to the 930A serial port.
- 4) Press the **OPTION MENU** key and enter Menu Option 3 by pressing any softkey under the display.
- 5) Once inside Menu Option 3, press Softkey 3 (under **SET-UP**).
- 6) If the printer's data format is not known, it can be determined from it's operating instructions. Set the 930A's baud rate, parity, character size and stop bits to match those of the printer.
- 7) Once the data format has been set correctly, and the 930A has returned to the Remote Control menu, press Softkey 2 until the display reads "**PRINTER**".
- 8) Exit from the Remote Control menu by pressing Softkey 4 (under **EXIT**) and the Printer mode will be initialized.









At this point, you will be asked a series of questions by the 930A regarding what parameters are to be printed out. These questions are:

| | |
|---|--|
| PRINT ERRORS? | YES $\overline{\text{NO}}$ |
|     |     |

To print PCM errors, whenever they occur, press Softkey 3 (under YES), otherwise press Softkey 4. In either case the 930A display will advance to the next question, which is:

| | |
|---|--|
| PRINT RECEIVED RECORDS? | $\overline{\text{YES}}$ NO |
|     |     |

To print calls captured by the digit receiver, press Softkey 3 (under YES). Press Softkey 4 if this printout is not wanted. If you answer YES, the display advances to:

| | |
|---|--|
| PRINT DIGIT ANALYSIS? | $\overline{\text{YES}}$ NO |
|     |     |

To print the analysis of the received digits, press Softkey 3 (under YES), otherwise, press Softkey 4.

The 930A display advances to the next question which is:

| | | | | | | | |
|--------------------|---|---|---|------------|-----|-----|-----|
| PRINT WINK TIMING? | | | | <u>YES</u> | NO | | |
| ▽ | △ | ◀ | ▶ | SK1 | SK2 | SK3 | SK4 |

To print the wink timing measurements, press Softkey 3, otherwise press Softkey 4. When the questions have been answered, you may exit from this Menu Option. The printer will begin to print whenever one of the conditions occurs, or if the ENT (Enter) key on the 930A is pressed. Press the ENT key to test your connection. If the output is garbled, adjust the baud rate, parity, or number of bits. To suspend printing for any reason, without taking the 930A out of the Printer mode, simply turn off the printer power.

NOTE: Taking the printer "Off-Line" may not have the desired effect since its' buffer may fill up with unwanted material which will be printed out when the printer is placed back "On Line".

5-4 DIGIT RECEIVER ANALYZER (MENU OPTION 4)



The Digit Receiver has 2 Menu Options which are installed in the Model 930A when **Option 930A-01: DP/MF/DTMF RECEIVER/ANALYZER** has been installed. These Menu Options appear under the **OPTION MENU** key as:

- 1) OPTION NUMBER: 4 **DIGIT RECEIVER**
- 2) OPTION NUMBER: 12 **WINK MARGINING**

The Digit Receiver Option can be used in **BRIDGE** mode on analog trunks, or the **MON-1/MON-1&2** modes on **PCM** trunks to monitor the interaction between equipment. In the **TERM** mode, the 930A can completely simulate terminating equipment. In either case the 930A will record the outpulsed digits it receives. In the **TERM** mode, the 930A will supply supervision. In the **BRIDGE**, or **MON-1/MON-1&2** modes, it will look for, and time, supervision events (Winks, Offhooks, etc.). The 930A breaks an outpulsing sequence into groups of digits and supervision events. The digit groups, which can be **MF**, **DTMF**, or **DP** sequences, are called Records. The supervision events are divided into Winks, Delays, and Off-Hooks.

Setup Menu Option 4: DIGIT RECEIVER by performing the following steps:

Press the **OPTION MENU**  **Option Menu** function key.

Use the **UP/DOWN**   arrow keys to select Menu Option 04: **DIGIT RECEIVER**.

The 930A display is shown below:

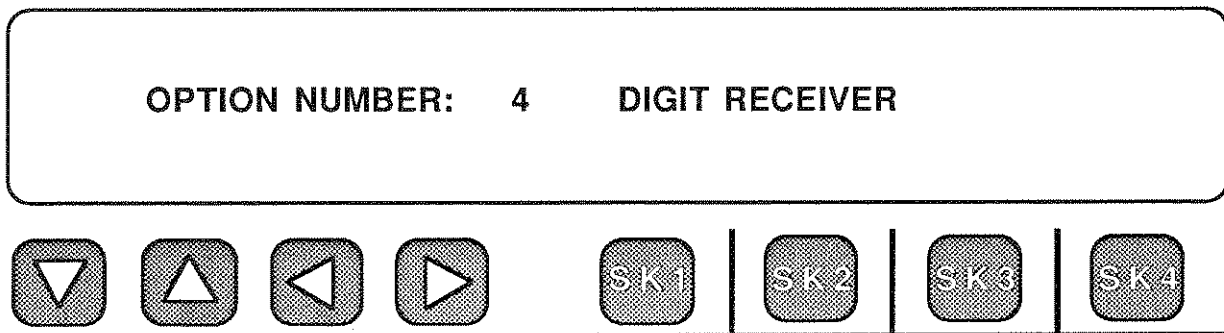

Press any softkey under the display to enter the menu. The main Digit

Receiver menu is shown below:

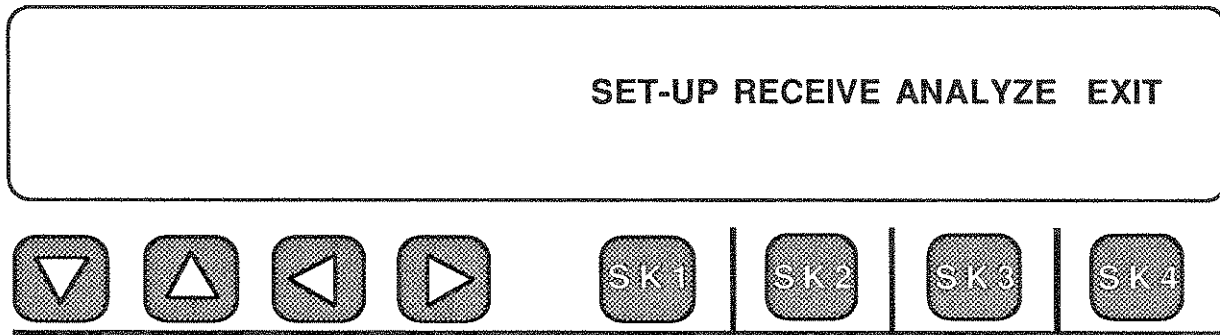

Press Softkey 1 (under **SET-UP**) to enter the set-up menu for the Digit Receiver. This requires you to know something about the types of calls on your trunks. The display will show the following choices:

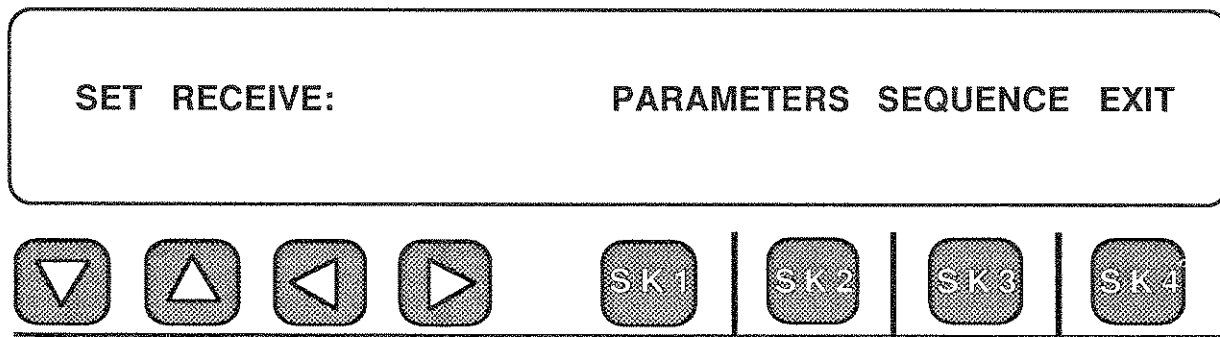

To set the **PARAMETERS**, you have to know whether the signaling on your Trunk is Multi-Frequency (**MF**), Touch-Tone (**DTMF**), or Dial Pulse (**DP**). If it is **DP** or **DTMF**, you will need to know how many digits in the call. The 930A default display of **PARAMETERS** is shown below:

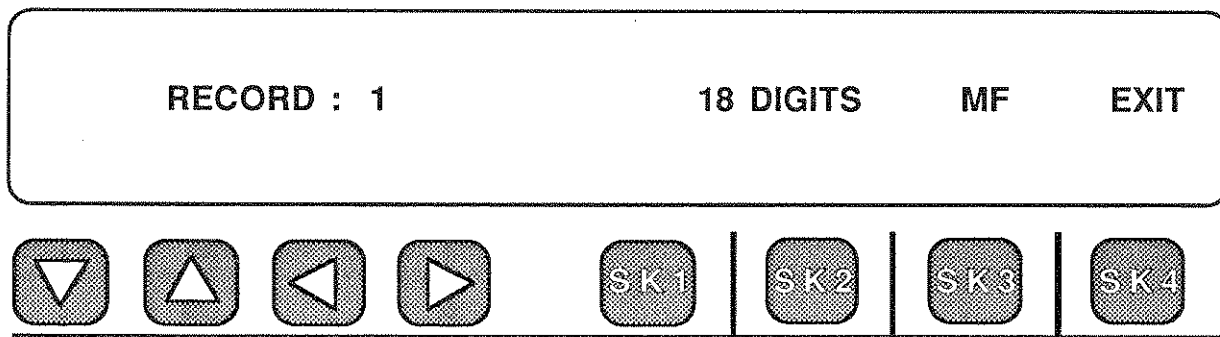

The "parameters" in this case are **MF** digits. The 930A treats each incoming call as a **RECORD**. Some types of calls may have as many as 3 Records in sequence. If the call is **MF**, you will need to tell the 930A the length of each called number. The 930A can tell where one **MF** string stops and the next one begins. The set-up displays all look the same except for the number. For example, the display below shows the default for Record 2.

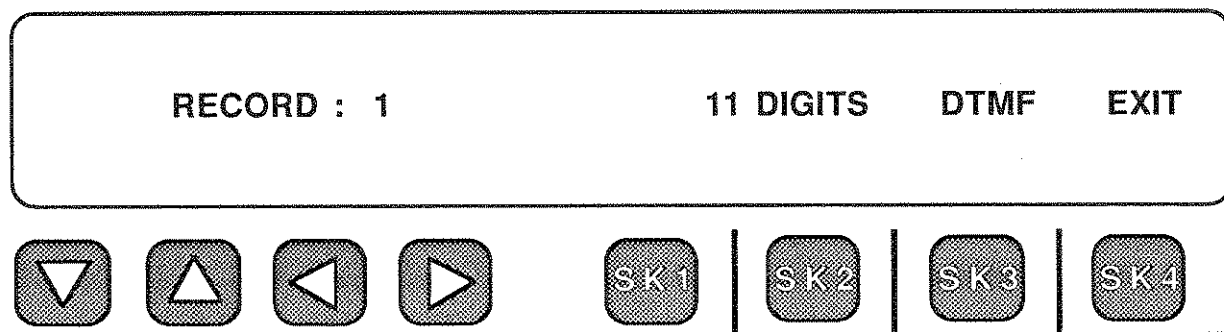
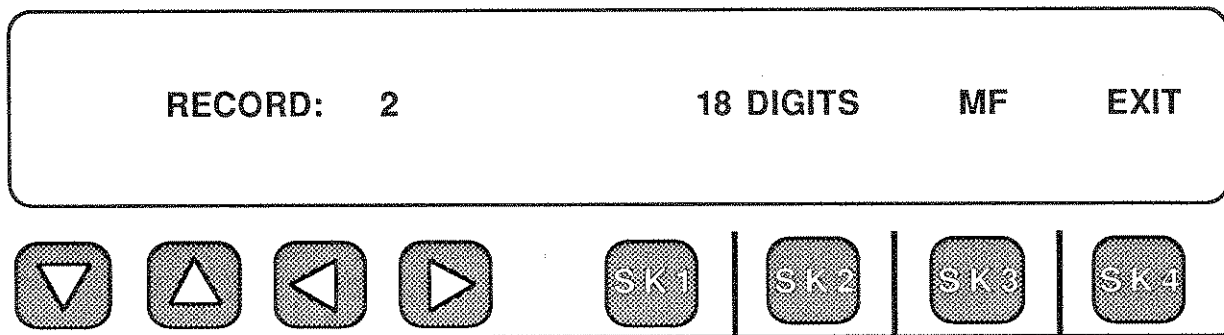

Once you have set the **PARAMETERS** for the type of call you want to receive, press Softkey 4 (under **EXIT**) to return to the **SET-UP** menu.

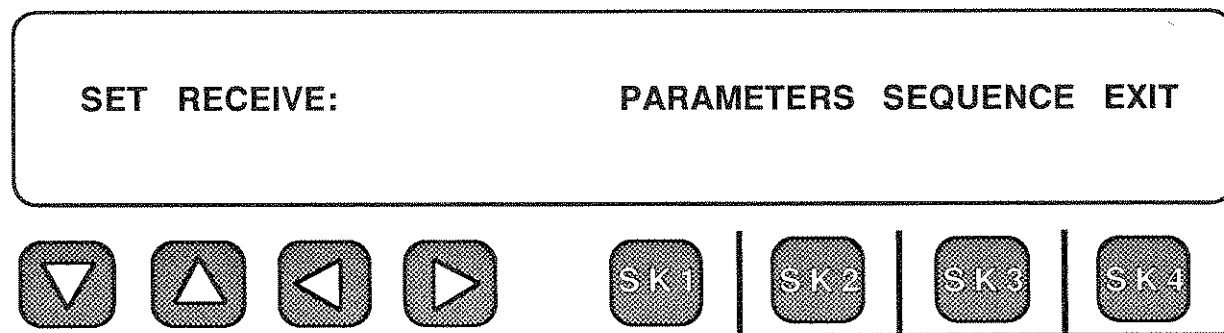

To set the **SEQUENCE** you press Softkey 3 under **SEQUENCE** in the set-up menu on the previous page. The 930A default display is shown below:

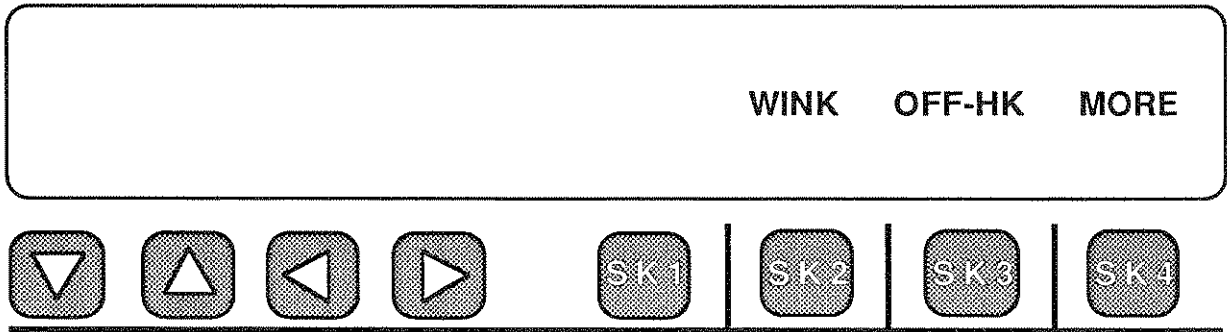

WINK START:

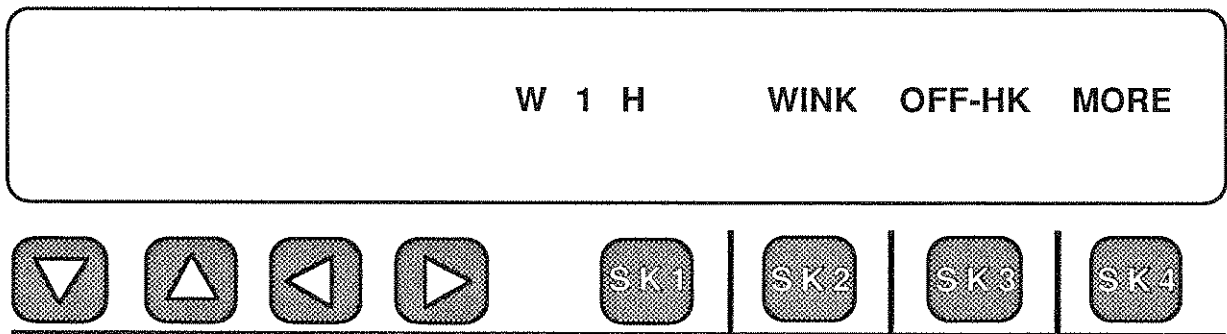

IMMEDIATE DIAL:

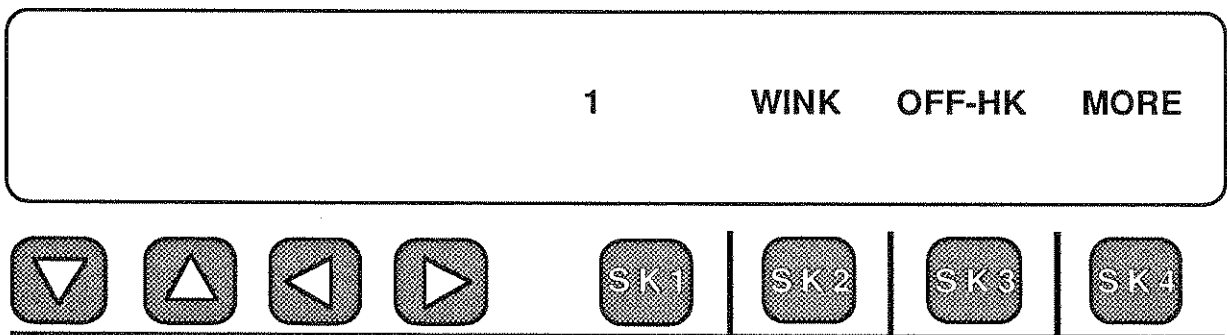

IMMEDIATE DIAL ON GROUND START:

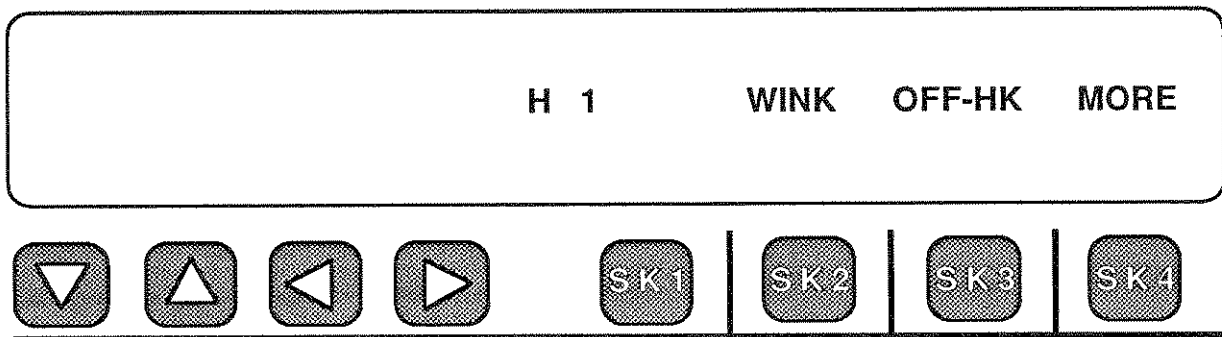

For the **Wink Start** Trunk, press Softkey 2 (under **WINK**) and the **W** appears. This tells the 930A to give the far end a **Wink** when it sees the Trunk being seized. The number **1** was entered to tell the 930A to receive a single "Record" (since this was a regular domestic call example) from the far-end. An **OFFHOOK** was entered so that answer supervision could be returned and timed. This was done by pressing Softkey 3 under **OFF-HK** and an **H** appeared after the **W 1**.

For the **IMMEDIATE DIAL** Trunk, you tell the 930A that a Record is coming right after the Trunk is seized. There are no winks involved. You enter a **1** from the keypad and press **ENTER**. This is shown in the display above. You could leave it at this just to capture digits, but it is a good idea to send back an **OFFHOOK** when you terminate a Trunk. So enter an **H**, after the **1**, by pressing Softkey 3 (under **OFF-HK**) and the display will read **1 H** instead of just **1**.

On a **Ground Start** Trunk, you must start with an **Offhook**. You enter the **H** first and then the **1**. The sequence would be **H 1** in this case.

After you have entered the sequence into the 930A, press the **OPTION MENU** key and you will see the main **SET-UP** display return:

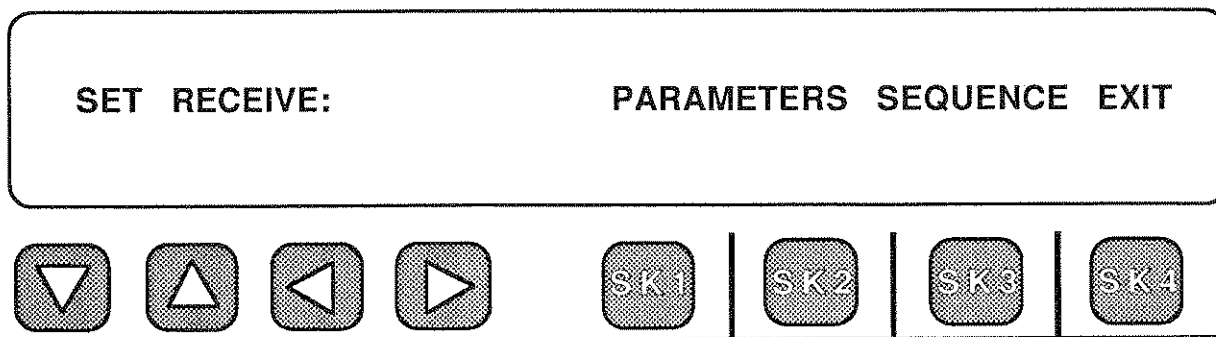

Now, press Softkey 4 (under EXIT) and the 930A display will back out another step to the main selection menu:

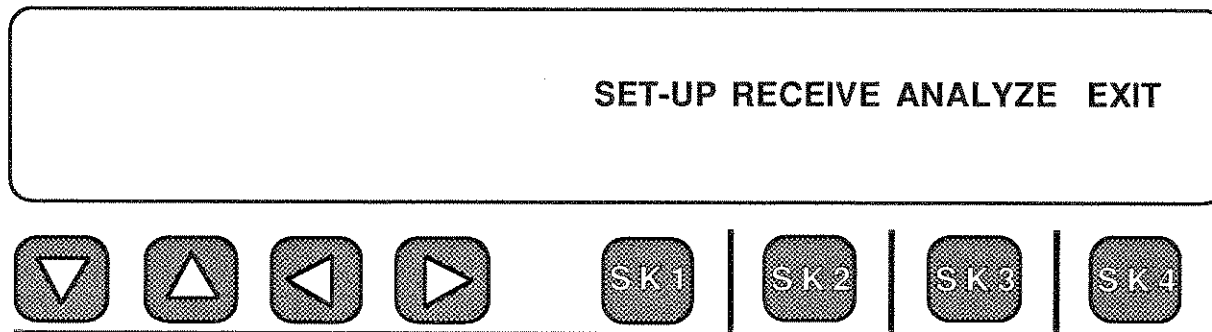

To receive digits, press Softkey 2 (under RECEIVE) to activate the digit receiver.

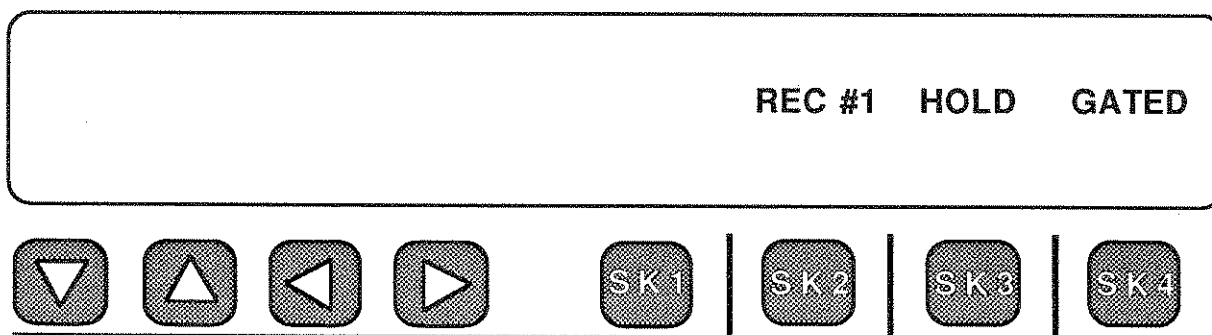

The next time the trunk is seized, and digits are sent, you should see them come across the 930A display. An example might look like:

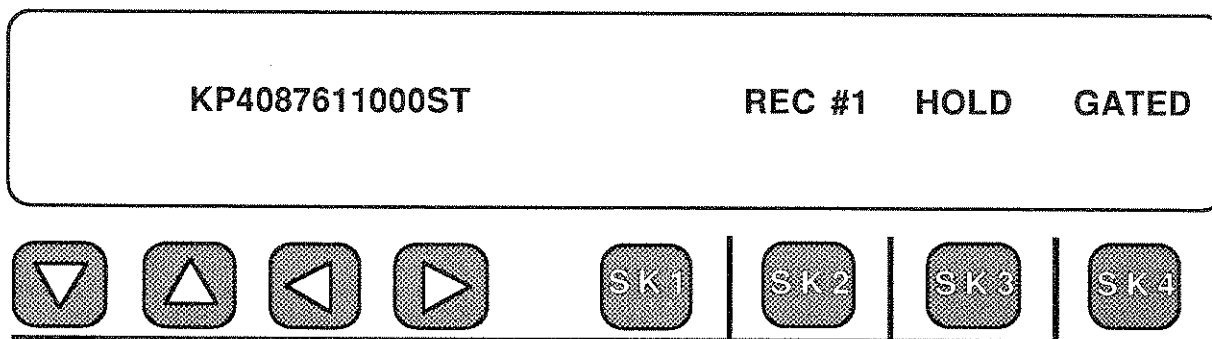

Once the digits have been received, you can press the OPTION MENU key to back out of the Receiver to the main display.

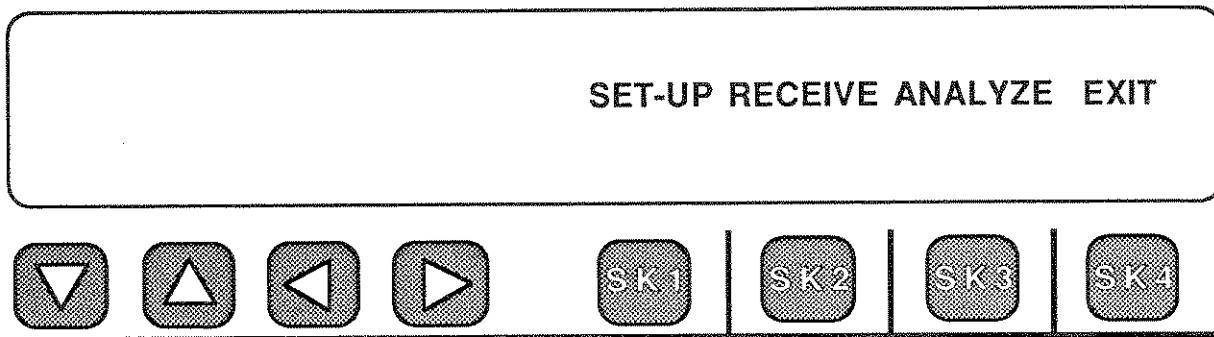

At this point, press Softkey 3 (under **ANALYZE**) to review the characteristics of each digit in the string you received. A sample display appears below:

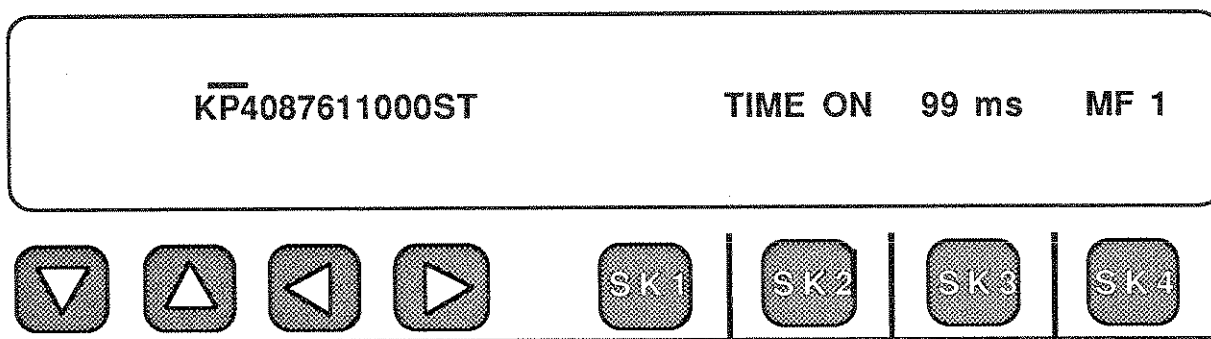

In the above example, an **MF** "Record" has been received. The cursor starts out over the first digit. In this case it is the **KP**. By pressing Softkey 2, you can page through the levels and frequencies of the two tones which make up the **KP** as well as their **On** and **Off** times. You can then use the right arrow key to move the cursor to the next digit, and so on.

If you had set the 930A to receive a Multi-Wink call such as a Feature Group D sequence, then the 2 or more "Records" would be stored in the Analyzer. You would be able to look at them by pressing Softkey 4 (under **MF 1**) in the example display on the previous page. This acts like a "wheel" and pages you through Records 1 to 4 and then back to 1 again.

Press the **OPTION MENU** key to back out of the Analyzer display. From the main menu, you can exit entirely from this Option, or go back into the Receiver to collect more digits.

If you have a Printer connected to the 930A, then the 930A will

automatically go on receiving digits, and print the Digit Analysis with a Time/Date stamp on the printout. Wink Timing results from Menu Option 9 will also be printed if you are testing on a 4-wire analog trunk or a T1 span (Option 930A-09E).

5-4.1 HOW TO RECEIVE CALLS ON PBX OR POTS TRUNKS

For a **LOOP START** trunk, assume that we want to Bridge onto the line, and not interrupt service.

To monitor a call on a **POTS** line, set the 930A **TRUNK TYPE** so that its display matches the one below:

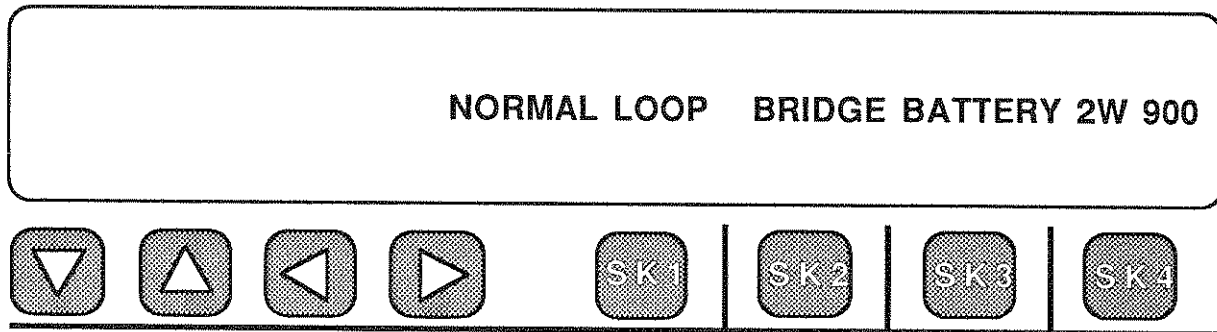

Now connect the T/R jack of the 930A to the Trunk access point. This is typically at the "66 Block" or **DEMARC** point. You would use a 310 to alligator clip test cord and clip onto the Trunk without pulling the Bridging clips from the **DEMARC**. The diagram below shows the connection:

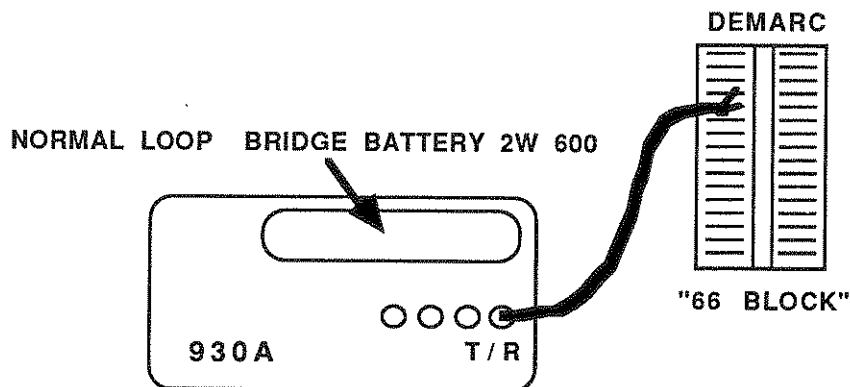

Before going to the **DIGIT RECEIVER** (Menu Option 4), check the front panel

Supervision LED's. They should match the status of the Trunk. That is, they should show **ON HOOK** on both **ORIG** and **TERM** if the trunk is idle. When the subscriber end goes **OFF HOOK** to dial the call, the **ORIG** LED should show **OFF HOOK**. When the call completes, the **TERM** LED should go **OFF HOOK**.

If these states are reversed then you need to set the **TRUNK TYPE** to **REVERSE LOOP** instead. The other settings remain the same.

Now you can press the **OPTION MENU** key and go to Menu Option 4: **DIGIT RECEIVER**. Press any softkey under the display to get to the main menu:

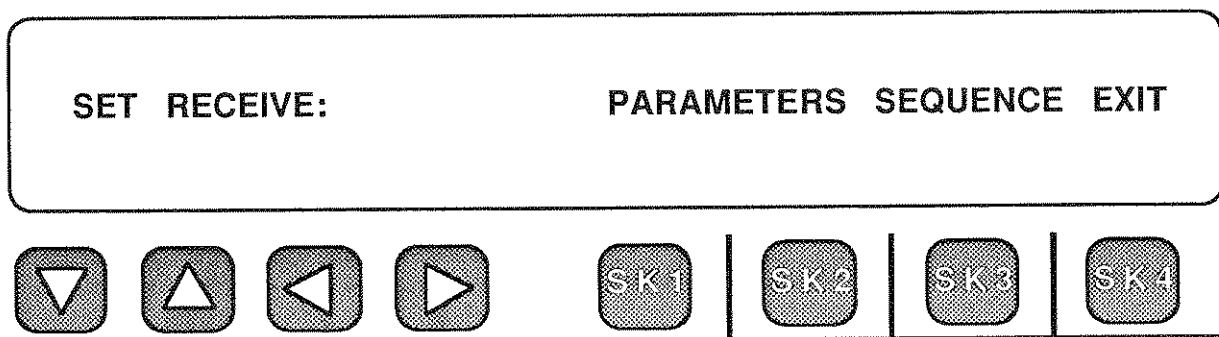
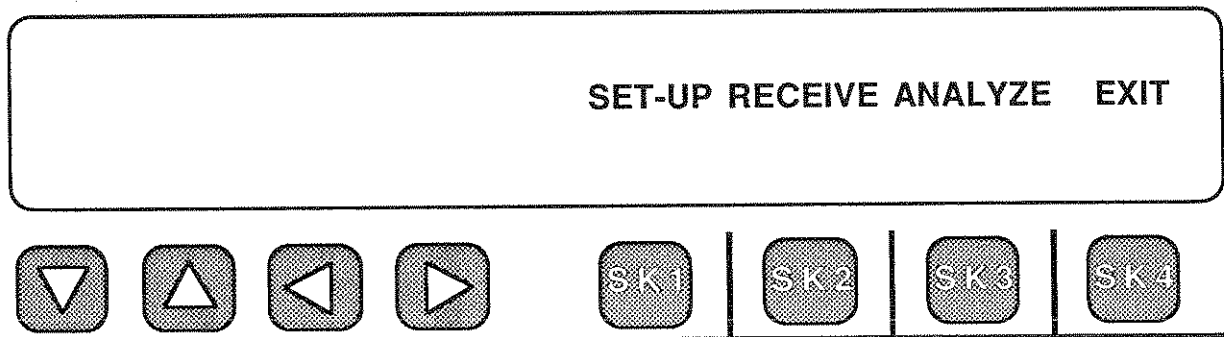

To select Touchtone digits, press Softkey 1 or 2 to get to the **PARAMETERS**. This brings up whatever the last selection happened to be. We can start from the default display of **PARAMETERS**.

The default parameter settings for the 930A has all 4 Records set to **MF**. So we have to change the default display for Record 1 shown below:

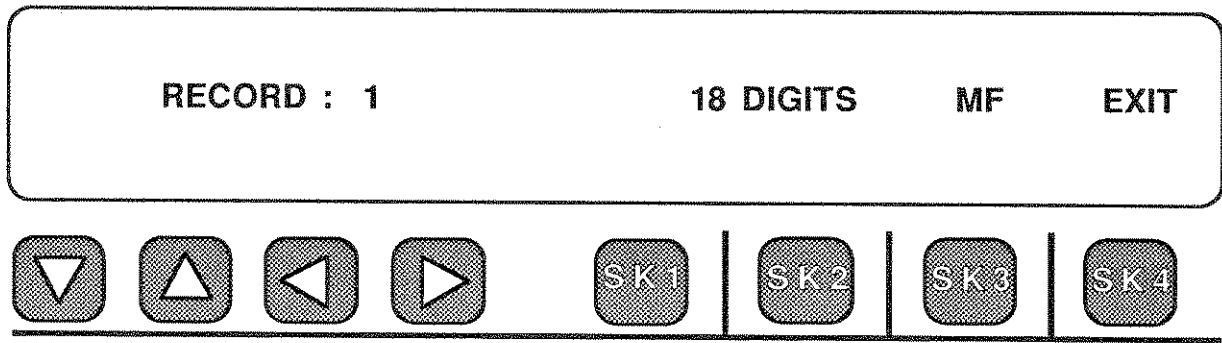

There will be only 1 Record for this type of call. Press Softkey 3 to change from MF to DTMF. Enter in the expected length of the called number using the keypad. Make it a local call, 7 digits long.

After you have correctly entered the length, the display will be:

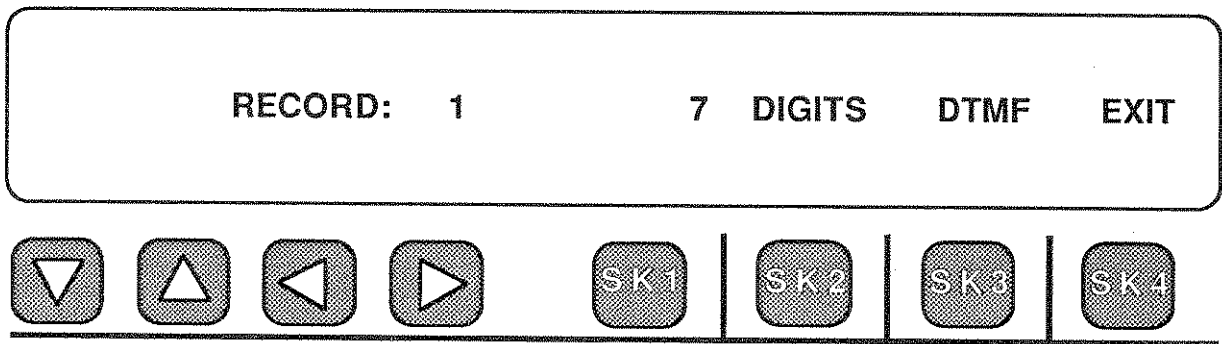

Now that you have set the parameters, the SEQUENCE is next. Press Softkey 4 (under EXIT) and the selection display returns:

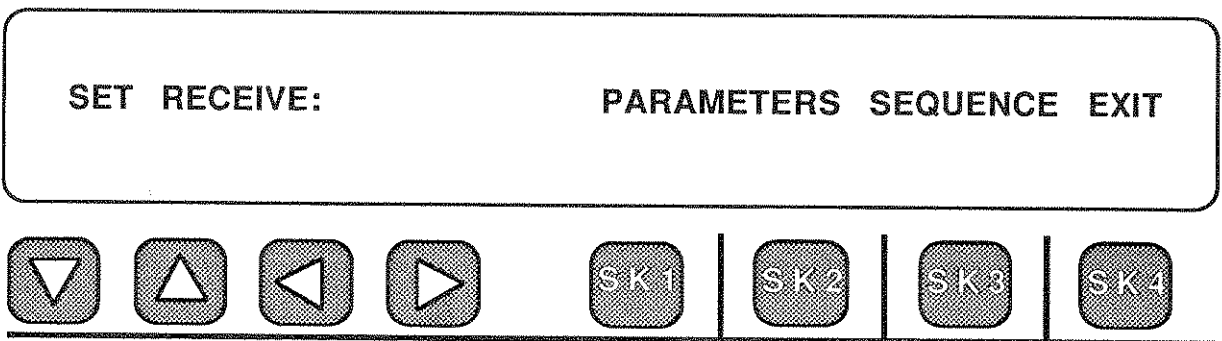

Press Softkey 3 (under SEQUENCE) and the display will change to:

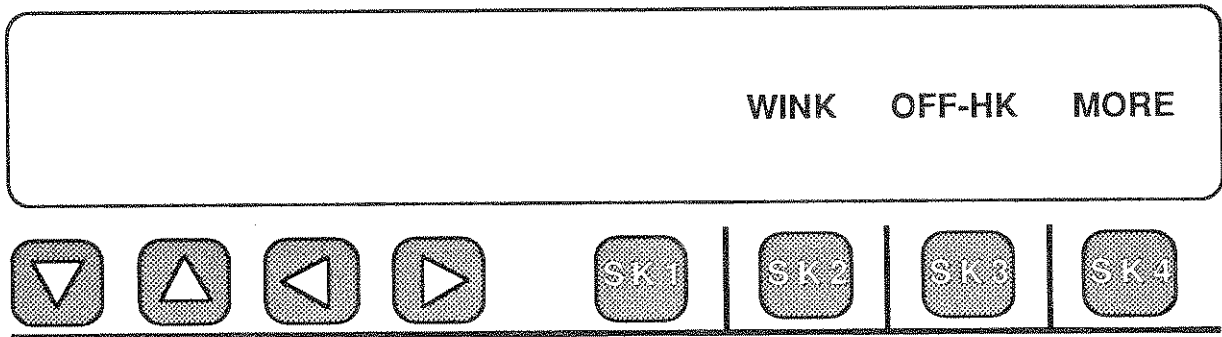

If a previously entered sequence is showing, press the **CLR** key. Enter a **1** from the keypad and press **ENTER**. The display now looks like:

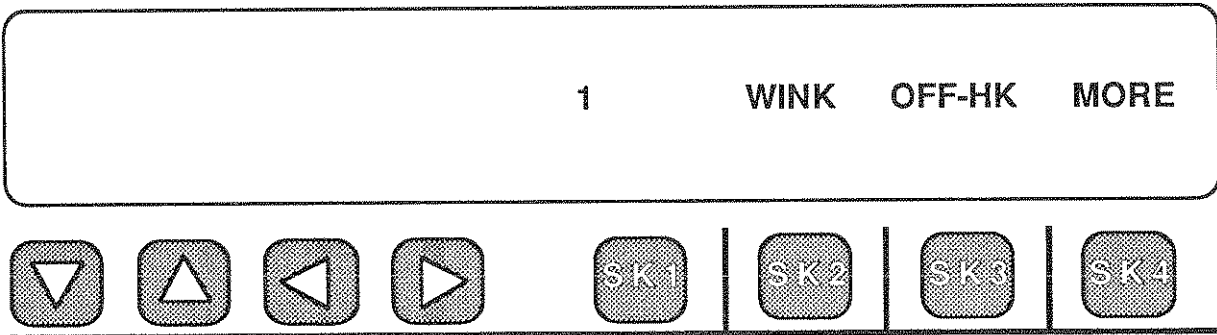

Next, press the **OPTION MENU** key to back out of this display into:

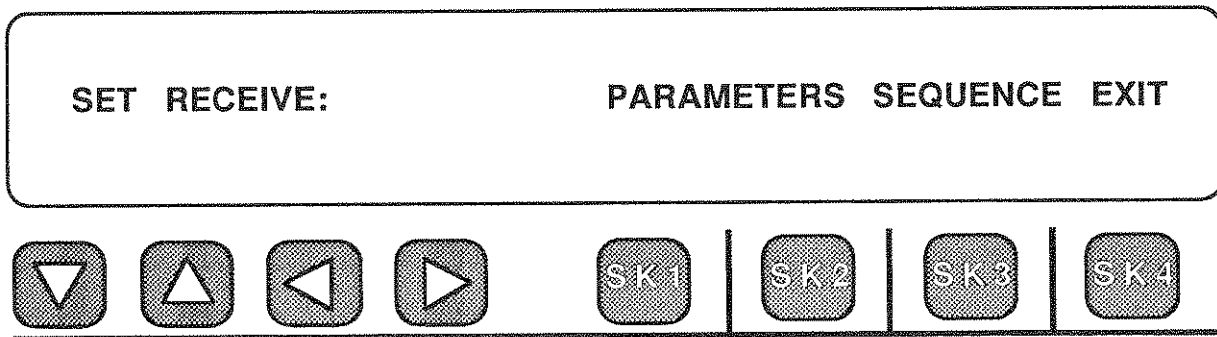

Press **Softkey 4** to exit back to the main menu:

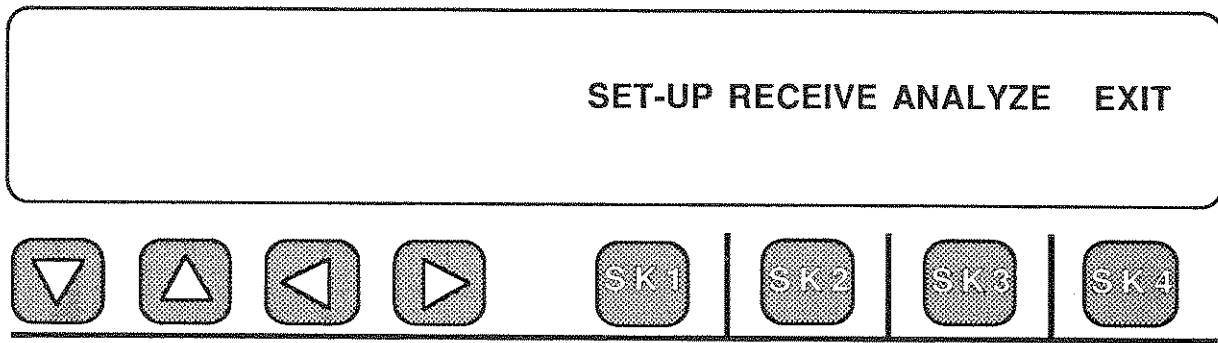

To receive the call and see the digits, press Softkey 2 (under **RECEIVE**) and the display should become:

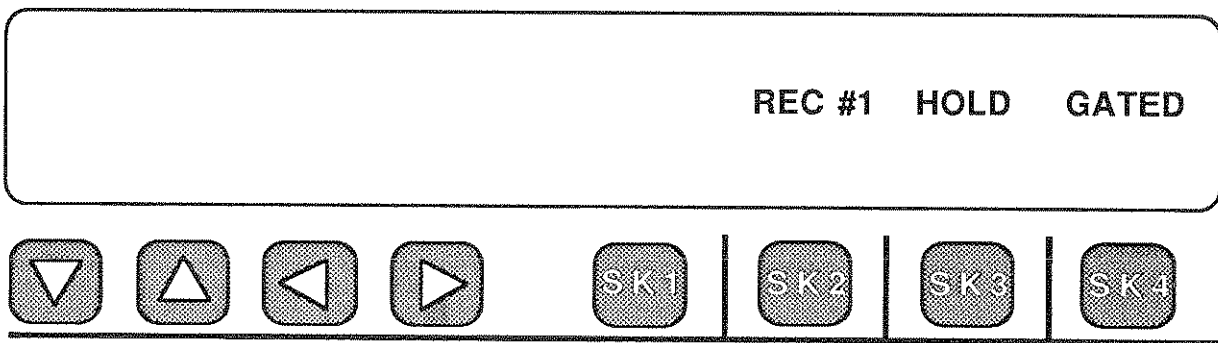

The 930A is waiting for the Trunk to be seized and digits dialed. When this happens, you should see them come across the display. Sometimes, it is necessary to disable the 930A supervision detection to get the digits.

To ignore supervision, press Softkey 4 (under **GATED**) and the **TRIGGER** display, shown on the following page, will be presented.

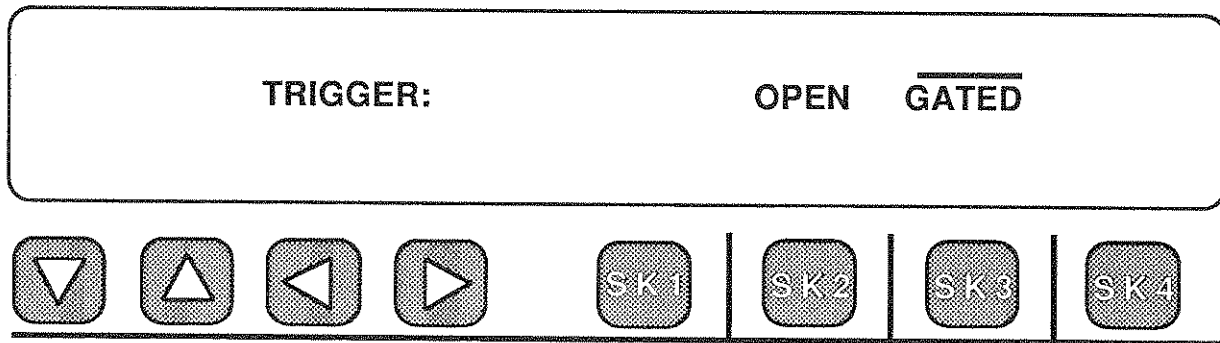

Press Softkey 2 (under **OPEN**) to select the **OPEN** mode. The display will become:

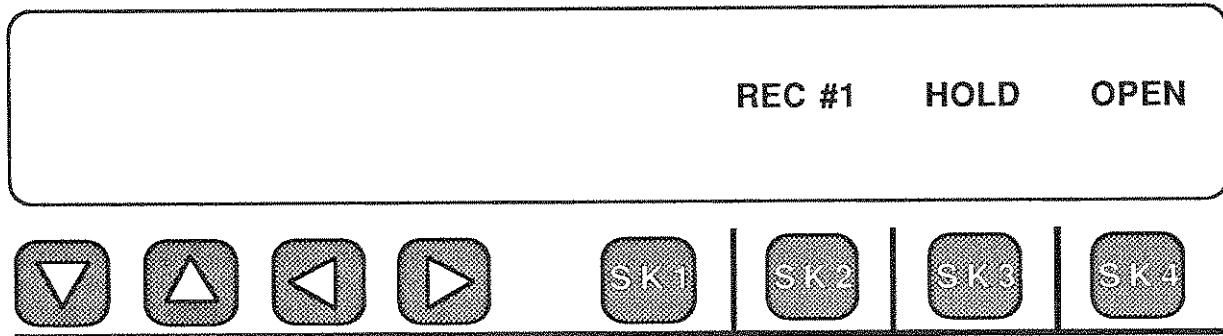

One way or the other, you will see digits come across the display when they are dialed. In the **OPEN** mode, the display might look like:

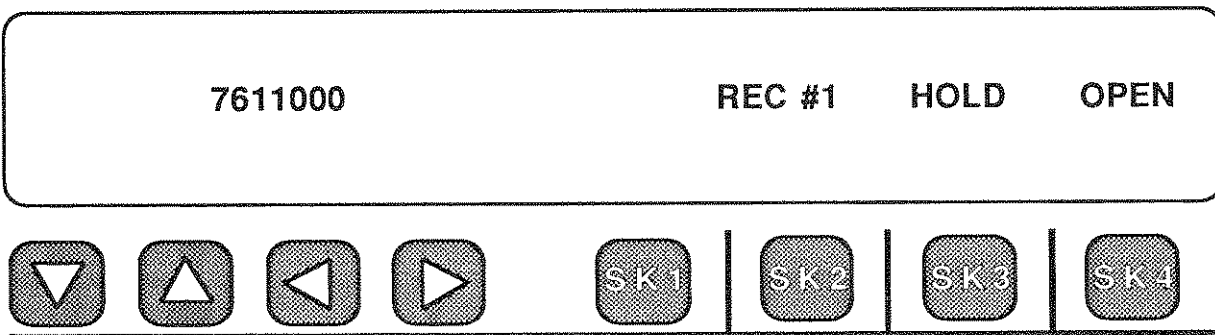

When receiving digits in the **OPEN** mode, you will have to ignore some of the "Errors" which will be displayed. **OPEN** is just what it says. This mode will make transients, speech and other things show up as "E's" before, in between and after, the digits you are capturing. In most cases you can ignore them and just look at the digits.

5-4.2 RECEIVING CALLS ON PBX GROUND START TRUNKS

Select the **NORMAL GND-ST** Trunk Type on the 930A and use the softkeys to change whatever appears on the display until it matches:

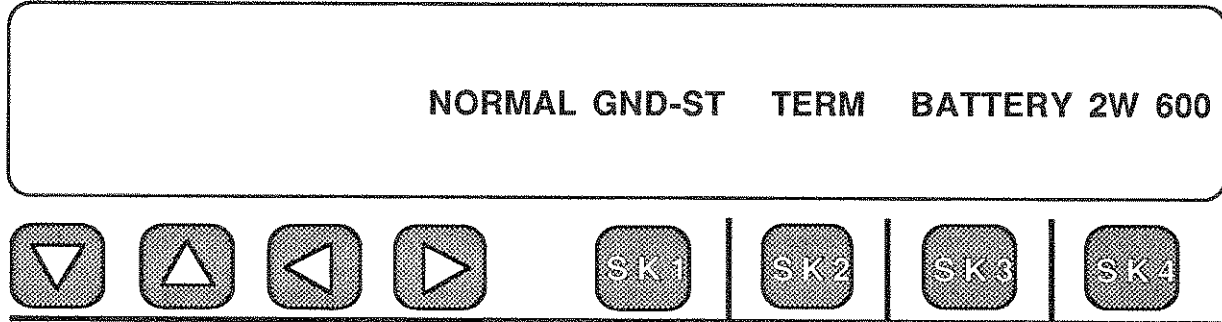

Again, this is a 2-wire trunk so the test cord connection at the **DEMARC** is the same as before except that now the Bridging clips have been pulled. The 930A will "look" toward the subscriber, simulate the Central Office, and supply Battery. The 310 to alligator clip test cord connection and 930A Trunk Type set-up is shown below:

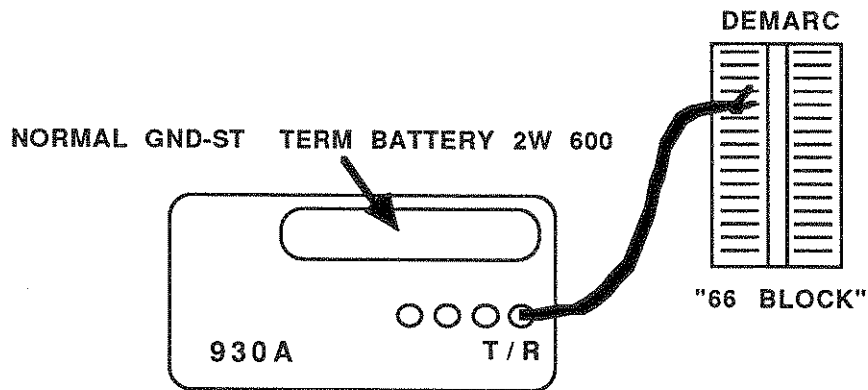

Once the test cord has been connected, check the front panel supervision LED's to make sure they both show **ONHOOK** when the subscriber phone is **ONHOOK**. If not, you may have to change the Trunk Type to **REVERSE GND-ST** to get the supervision correct.

Now you can press the **OPTION MENU** key and go to Menu Option 4: **DIGIT RECEIVER**.

OPTION NUMBER: 4 DIGIT RECEIVER



Press any softkey under the display and you get inside to the main menu:

SET-UP RECEIVE ANALYZE EXIT



Again, you have to get into the **SET-UP** menu first unless you have already set the 930A previously. For this example, assume that we want to capture some digits from a Dial Pulse or Rotary phone. For simplicity we can also specify it to be a 7 digit long number. After pressing **SET-UP**:

SET RECEIVE: PARAMETERS SEQUENCE EXIT



Press Softkey 1 or 2 (under **PARAMETERS**) to get to the menu below:

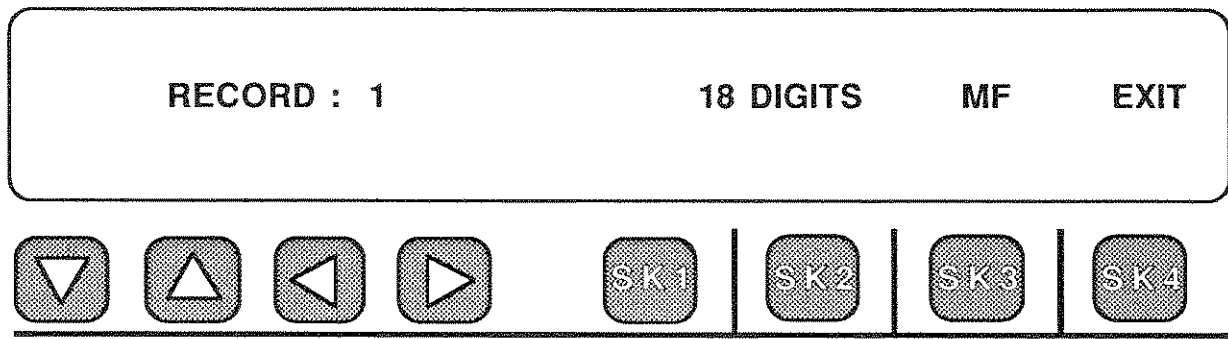

To enter 7 digits of Dial Pulse, press 7 on the keypad and then **ENTER**. Press Softkey 3 until **DP** appears and the display looks like:

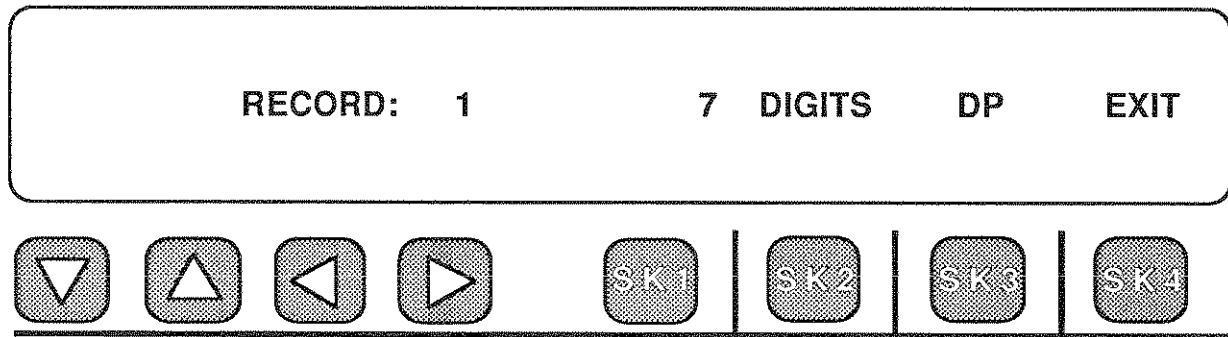

Now press Softkey 4 to exit back to the **SET-UP** menu:

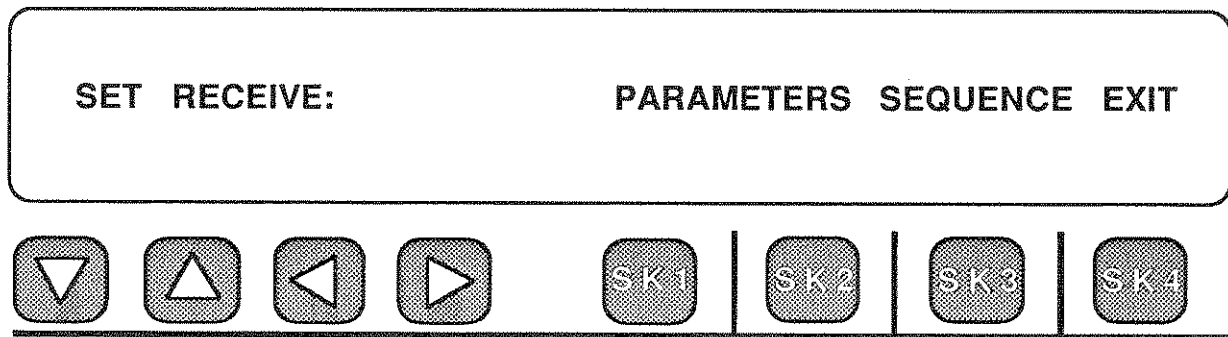

To enter the **SEQUENCE**, press Softkey 3 to get the display:

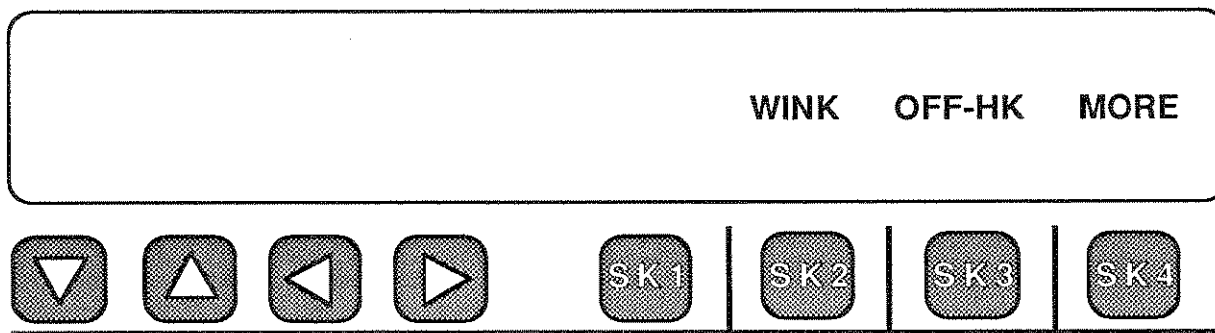

If there is a sequence displayed from a previous setting, press the **CLR** key. **Now you can enter** the sequence for a Ground Start Trunk. **Remember** that this type of Trunk has to "see" an **OFFHOOK** first. Press Softkey 3 (under **OFF-HK**) and enter the number **1** from the keypad. The display will look like the one below when you have entered the sequence correctly:

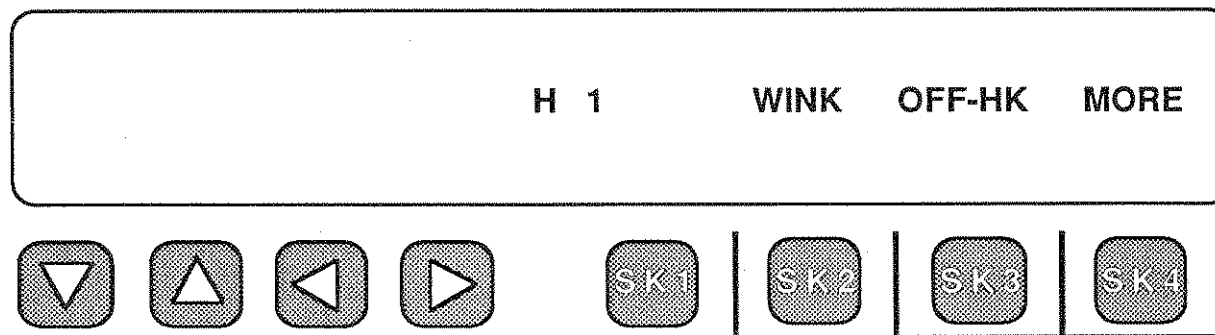

Press the **OPTION MENU** key to back out of this menu.

The **SET-UP** menu reappears:

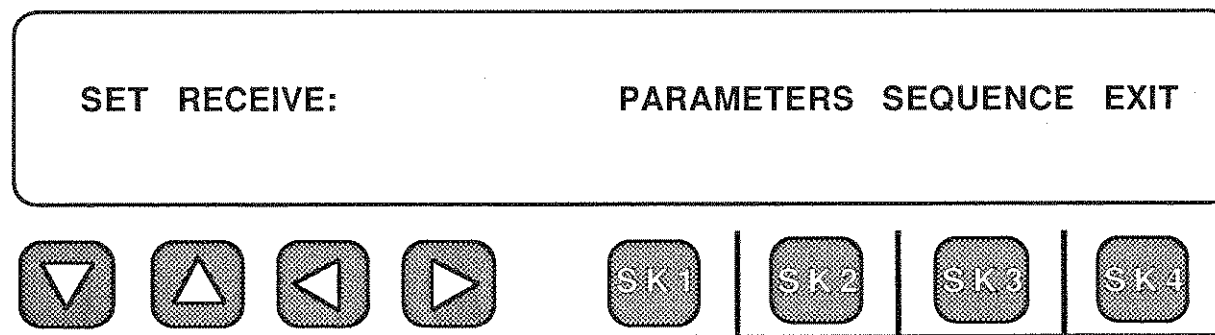

Press Softkey 4 to exit back to the main menu:

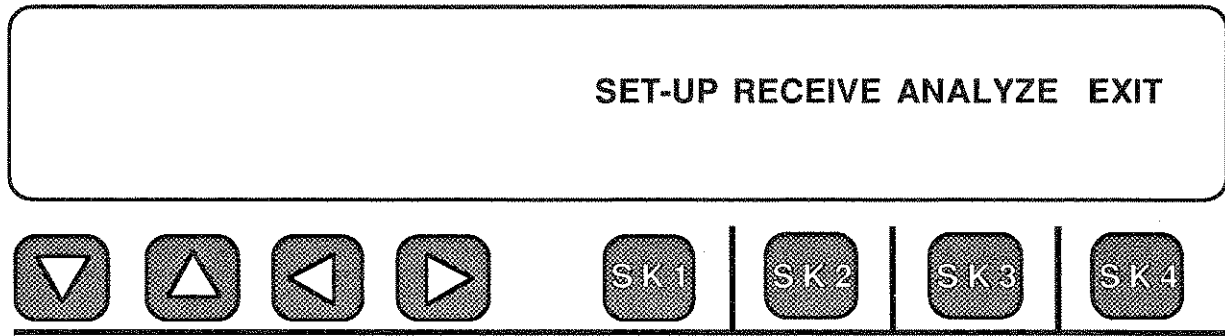

Press Softkey 2 (under RECEIVE) and the 930A will wait for the Trunk to be seized and digits will be captured.

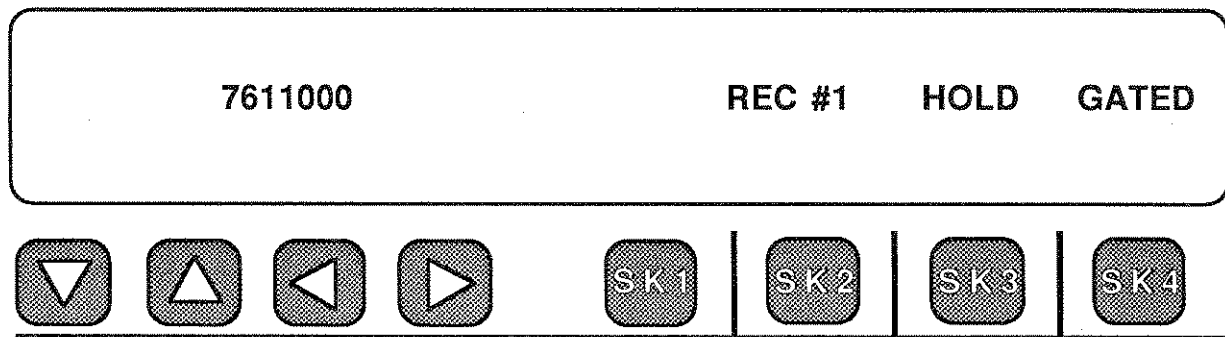

Once the digits are "captured," you can press the **OPTION MENU** key to back out of the receiver, and then select **ANALYZE** to check the digits.

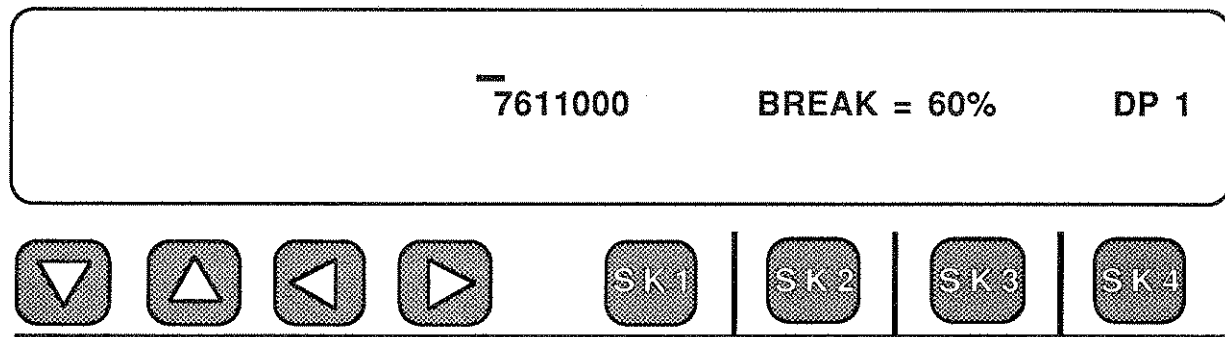

You can check the %Break, Pulse Rate and Interdigit Timing of the Dial Pulse digits in the same manner described for the MF digits of the previous example. If you have the 930A connected to a PRINTER, the analysis will be printed out automatically.

You could just as easily have received Touchtone digits by selecting DTMF under the PARAMETERS Set-Up instead of DP. The SEQUENCE would remain the same for a Ground Start Trunk. You could Bridge onto the line instead of Terminating it by going to BRIDGE in the TRUNK TYPE display.

5-4.3 RECEIVING AN EQUAL ACCESS CALL SEQUENCE ON A T1 PCM CHANNEL

To begin, your 930A must be equipped with Option 930A-09E, in addition to Option 930A-01, for this example to be useful.

The first step is to set up the PCM Trunk Type on the 930A and connect it to the T1 span at the DSX Monitor jacks. Normally, you monitor both directions on the T1. The test cords are connected from the 930A's PCM INPUTS 1&2 to the DSX Monitor jacks as shown below:

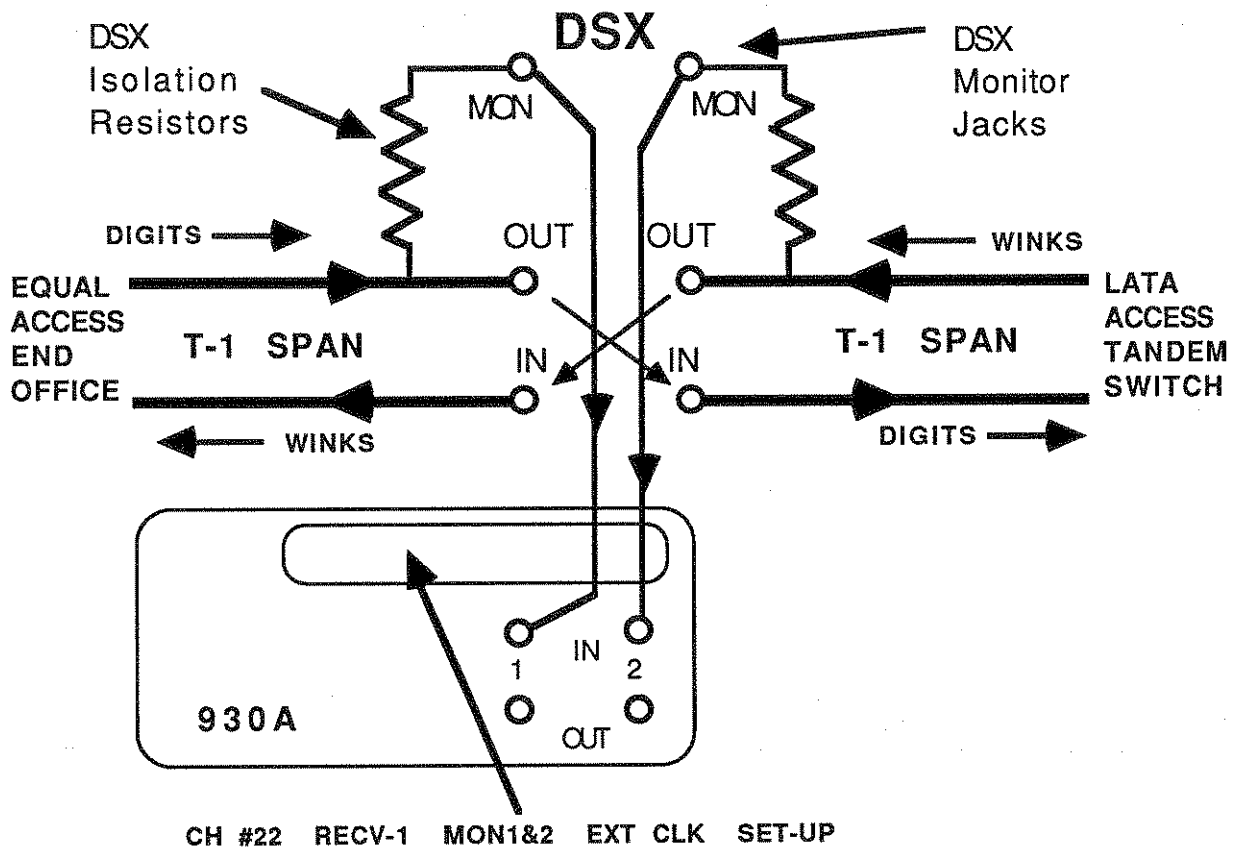

This diagram shows a Feature Group D call coming from the End Office into the Access Tandem with the 930A connected between the offices. **PCM IN 1** (the **RECV-1** side) is connected to the side the digits are coming from at the Monitor jack of the **DSX**. **PCM IN 2** is connected to the **DSX Monitor** jack from the Access Tandem switch. The Winks come from the Access Tandem. The 930A is set to monitor both directions.

Press the **TRUNK TYPE** function key and then press Softkey 1. The following display is shown:

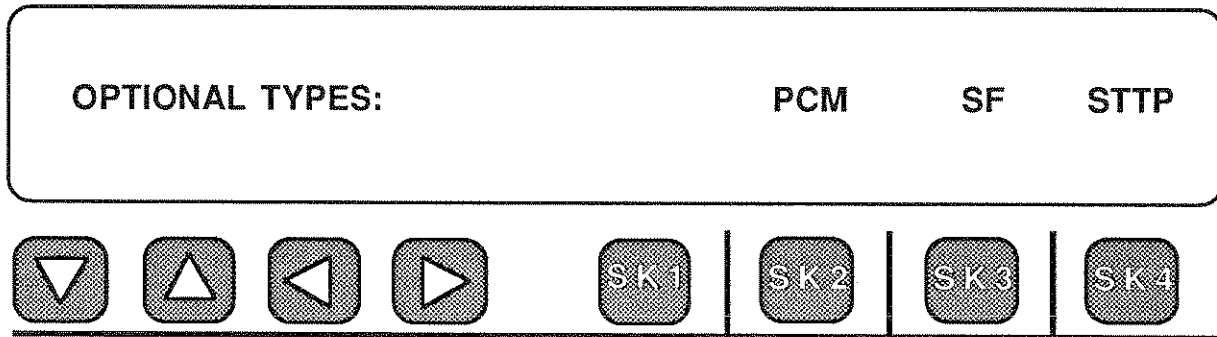

Press **Softkey 2** (under **PCM**) to bring up the main **PCM** display. The default display is:

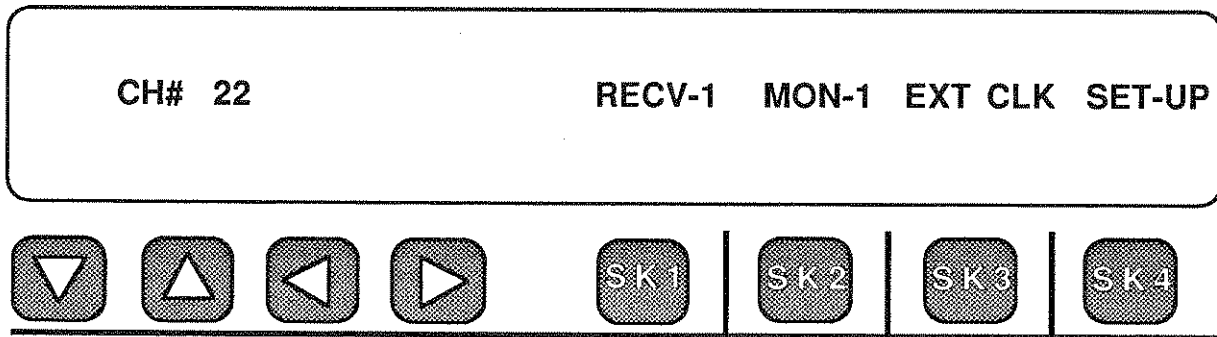

To monitor both directions of transmission, press Softkey 2 (under **MON-1**) and the Mode Selection display will appear:

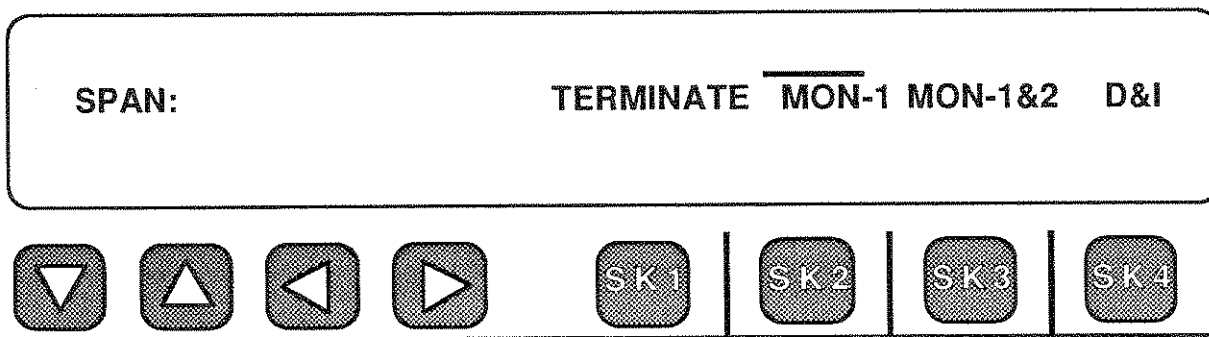

Choose **MON-1&2** by pressing Softkey 3 and both of the 930A's **PCM** receivers will be activated. The display will change below:

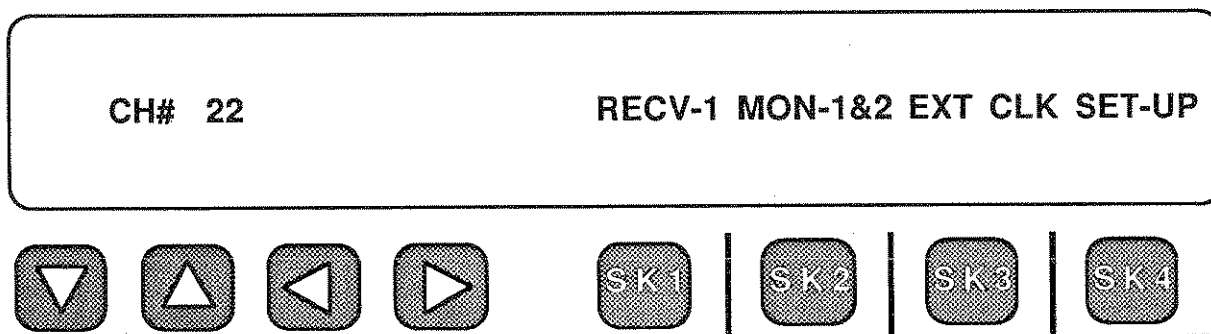

You can choose any channel you want from the keypad. You can change direction from **RECV-1** to **RECV-2** and back by pressing Softkey 1. Softkey 3 is purposely not active to make sure you are Loop-Timed in this mode. The **PCM SET-UP** under Softkey 4 should be left at the factory default settings, unless you know you need to change them.

Now that you have set up the **PCM Trunk Type**, press the **OPTION MENU** key, enter the number **4** from the keypad, and press **ENTER**. The **DIGIT RECEIVER** main menu will appear:

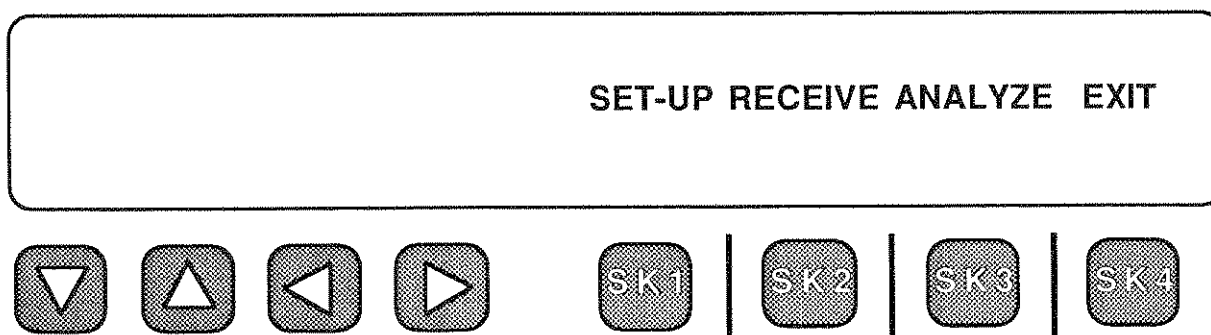

You usually check the **PARAMETERS** and **SEQUENCE** before you try to **RECEIVE** digits unless you know that your settings have not been changed from your last entries.

Press Softkey 1 (under **SET-UP**) and the main **SET-UP** display will be presented:

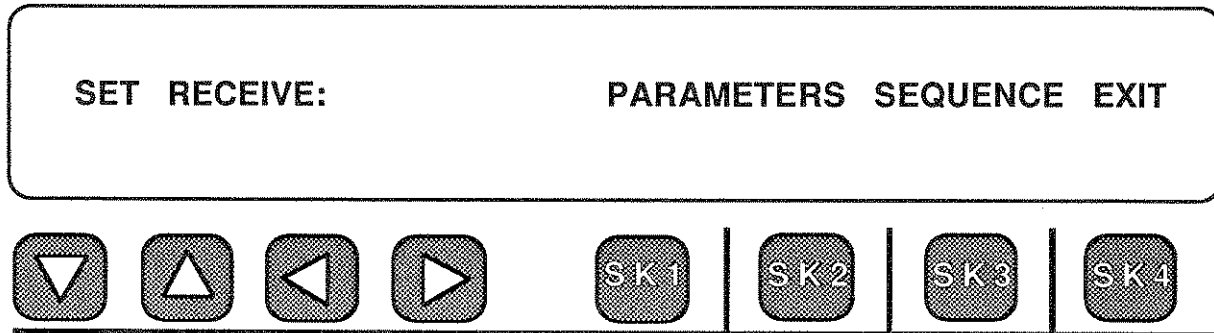

Now you need to know what a Feature Group D call progression sequence looks like, and what type of digits it is made of.

At this point, it is a good idea to refresh your memory about Feature Group D Equal Access calls into an Access Tandem.

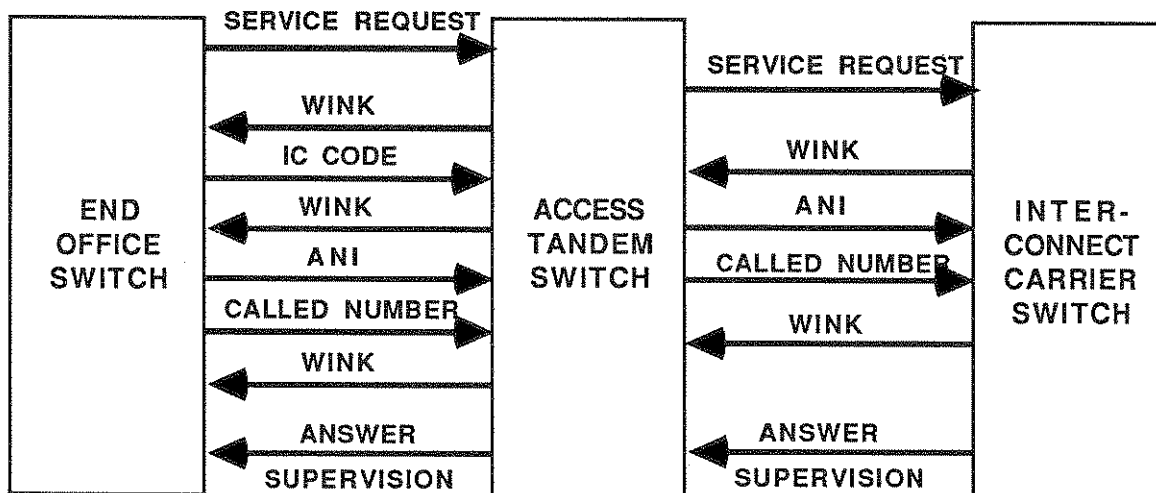

Going into the Access Tandem, the End Office supplies the customer's Long Distance, or Interconnect Carrier's code (To identify MCI, AT&T, SPRINT, etc.), the number the customer is calling from (**ANI**), and the number the customer is calling. **The call progression is:** The End Office seizes the PCM Channel; the Access Tandem responds with a Wink; the End Office sends the 6 digit IC Code; the Access Tandem gives a Wink after receiving the IC Code; The End Office sends the **ANI** followed by the **called number**; the Access Tandem gives a final Wink after receiving them; the far-end goes Off-hook when the call completes. **Now we can return to setting up the 930A.**

From the SET-UP menu:

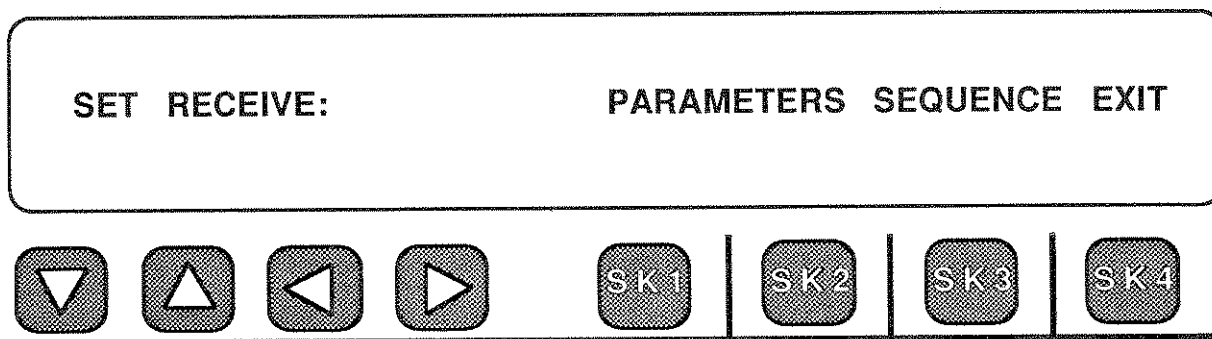

Make sure that the **PARAMETERS** are all set to **MF** digits and each of the **Records** is set to 18 digits length. The displays for Records 1 to 4 should all resemble the ones below:

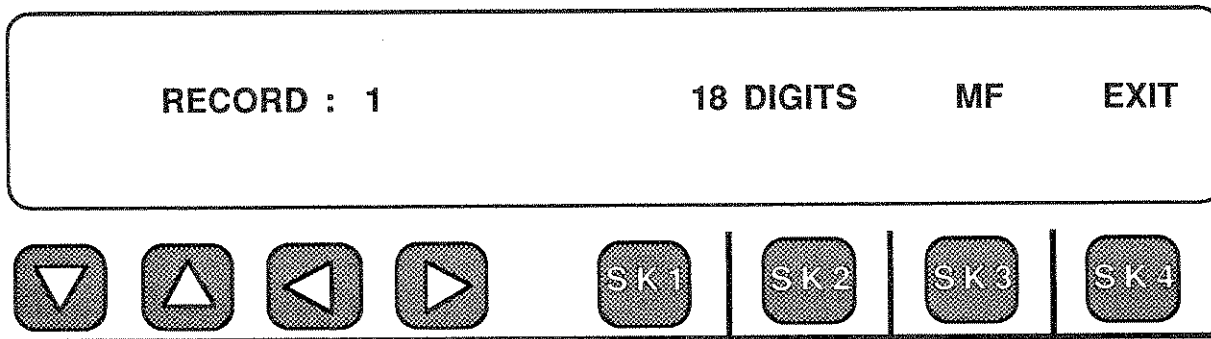

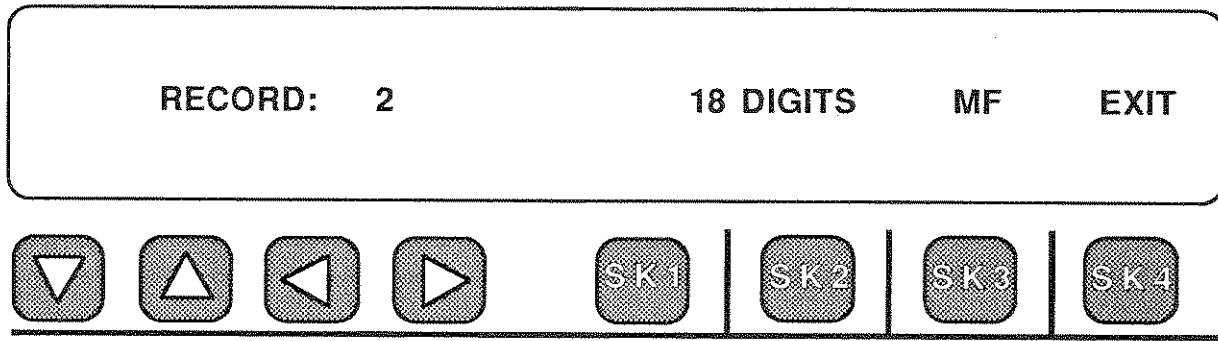

When you are satisfied that all the Records are set to expect **MF**, press Softkey 4 and **exit** back to the main **SET-UP** menu. From there you can enter the **SEQUENCE** menu shown below:

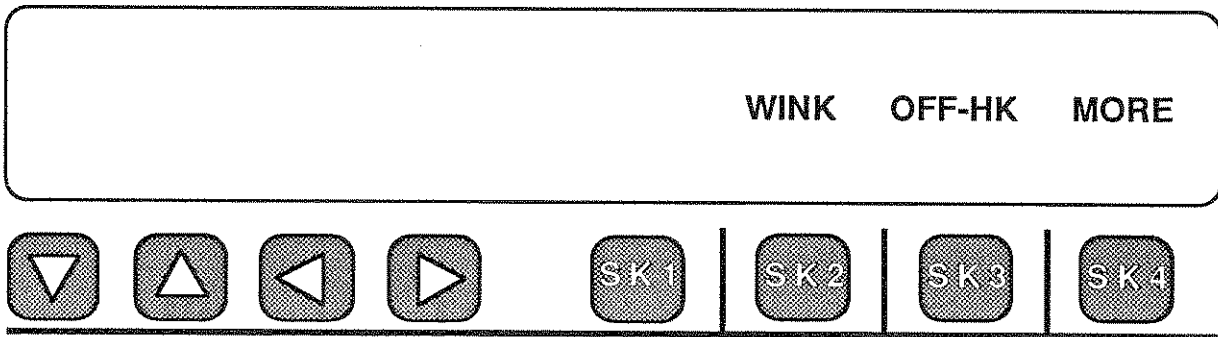

Begin by having the Receiver look for the **Wink** from the Tandem Office. Then you get the **IC Code**, followed by another **Wink**. The **ANI** and the **Called Number** come through next and are followed by a **Wink**. After the call completes you also get the **OFFHOOK**. To the 930A, all this can be reduced to a simple sequence of events. **From the display above**, press Softkey 2 to enter the first Wink, then enter the number **1** for the first Record (**IC Code**), press Softkey 2 again for the second Wink, enter a **2** for Record 2 (the **ANI**), enter a **3** for Record 3 (the **called number**) and, finally, press Softkey 2 for the final Wink. The 930A display will look like the one below when you have correctly entered the call sequence:

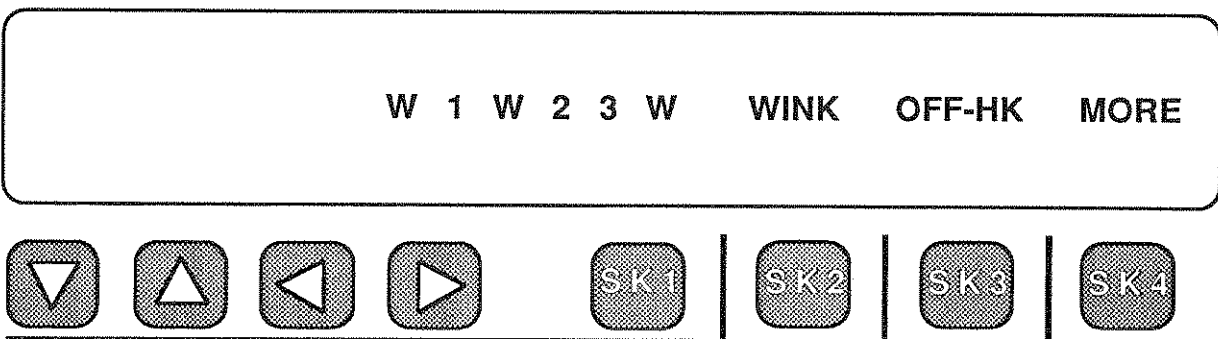

If you add an **OFFHOOK** at the end, it will look like the following:

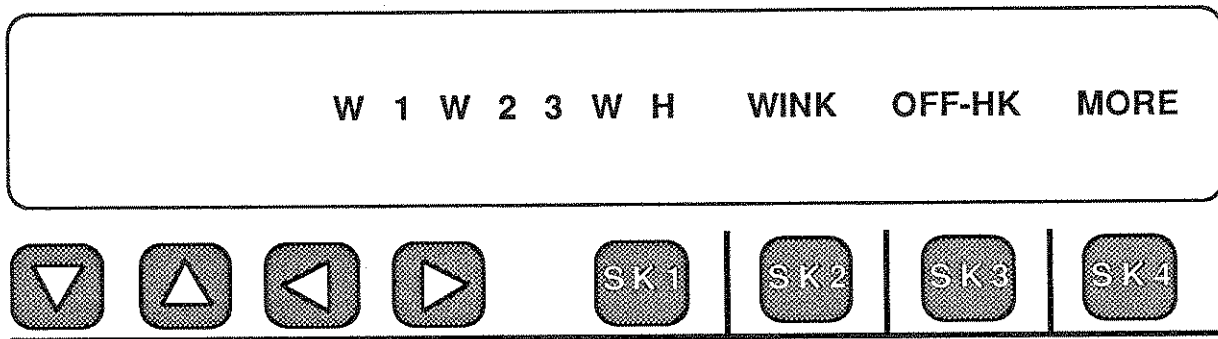

At this point, the receiver sequence is set up for a **three-stage, multi-wink, Feature Group D** call. Press the **OPTION MENU** key to return to the main menu and then press Softkey 2 to select **RECEIVE**. The 930A display will initially become:

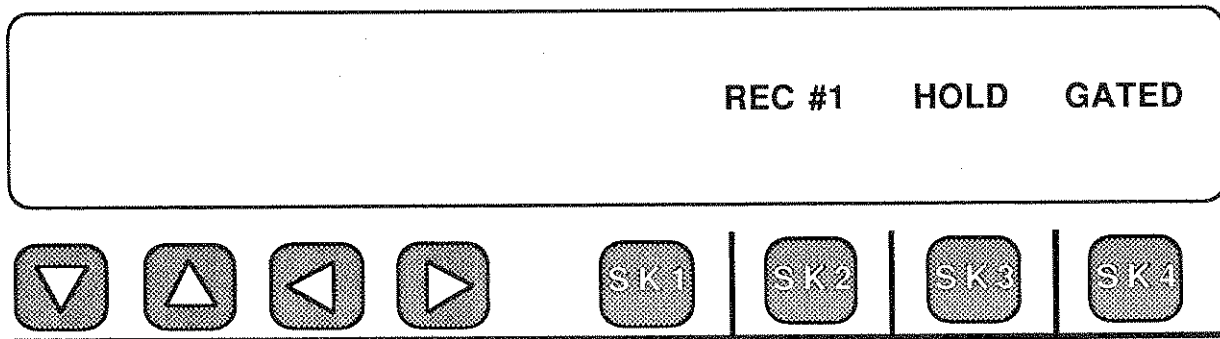

5-4.4 USING THE DIGIT RECEIVER SCAN MODE

To **activate** the **SCAN** mode, press Softkey 4 (under **GATED** in the display on the previous page), and the **TRIGGER** display will appear:

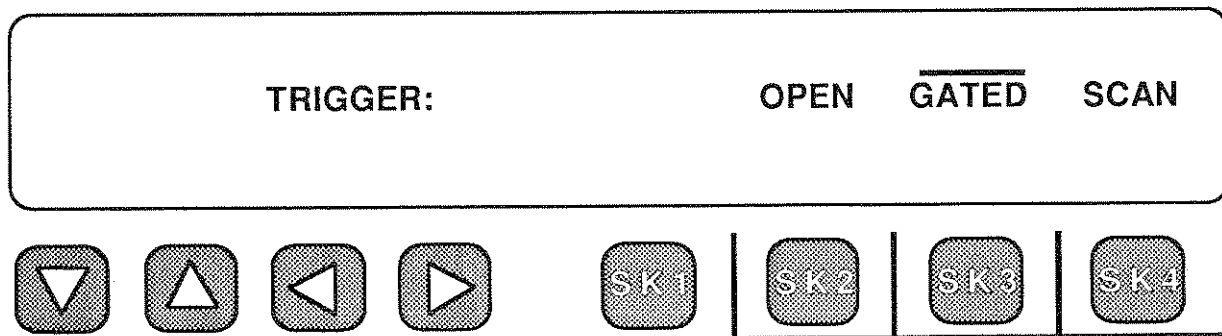

The cursor is flashing over the previous selection which was **GATED**. Press Softkey 4 (under **SCAN**) to activate the **SCAN** mode. The display becomes:

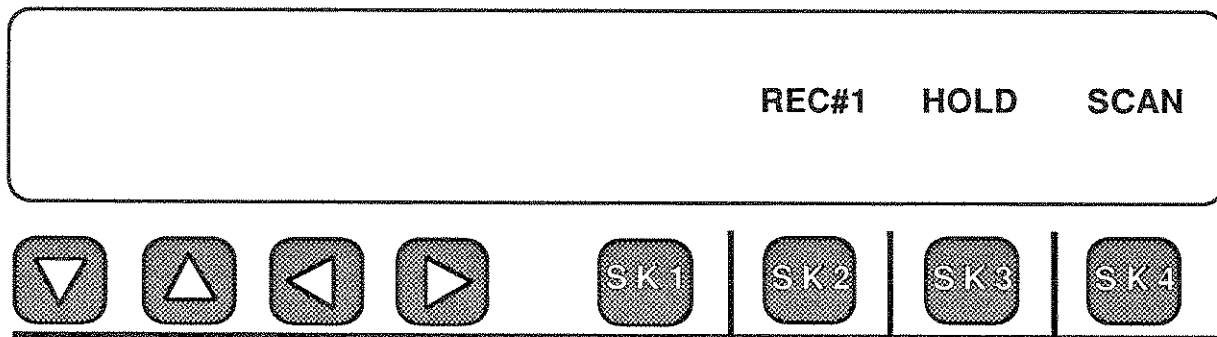

Do not worry if the display says **REC#2** or **#4** instead of **REC#1** because this is a random display until the Trunk is seized.

The **930A** will now jump to the next **PCM Channel** that goes **OFFHOOK** and begin to capture digits.

The **SCAN** mode only works with the **930A** in **PCM Trunk Type** since there is no need for it on an analog Trunk.

After you have received the call sequence, press the **OPTION MENU** key to back out of the **RECEIVER**. Select the **ANALYZER** to review the digits as described in the previous examples.

5-4.5 MORE ABOUT EQUAL ACCESS CALLS

Without too much detail, you now know that the digits are going to be **MF**, regardless of what the sequence looks like, because you are connected between switches in this case. This means that all you have to do is change the **SEQUENCE** part of the **SET-UP** menu. It is still a **Wink Start** Trunk, whether it is a **T1** or an **E&M Type I, II, or III**.

If the call is coming toward you from a "smart" End Office that strips off the **IC Code** and the **ANI** information before it gets to you, all you have left is the **Called Number**. This reduces the sequence down to a one-stage **Wink Start** call. The **930A SEQUENCE** display would be set to:

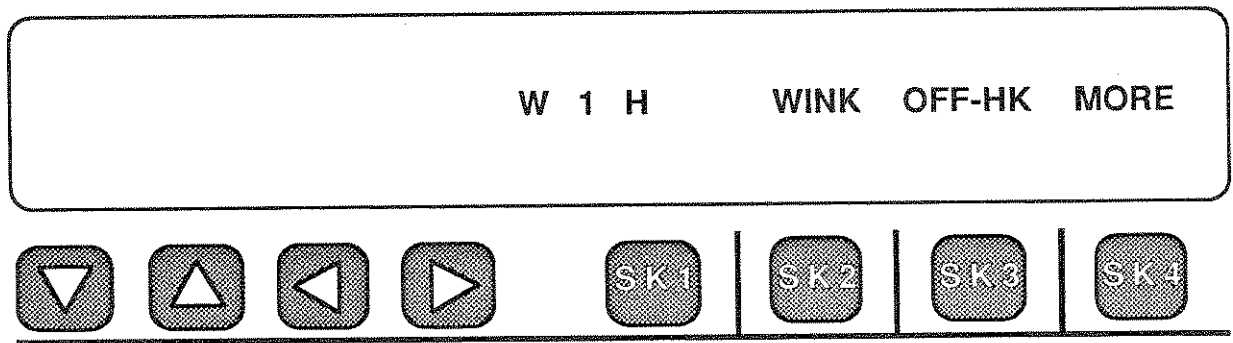

Then repeat the procedure for getting out of this menu and into the **RECEIVE** display.

If you are testing at the output of the Tandem Office toward the Interconnect Carrier, instead of on the End Office side of the Tandem, then the sequence is a little different. Assume that the End office is not a "smart" office and the full Feature Group D sequence of the previous example has come into the Tandem. The Tandem uses the IC Code to route the call toward the designated Interconnect Carrier. But once it has chosen the proper facility, the information is no longer needed.

This leaves us with the Calling Number (**ANI**) for billing, and the **Called Number** to complete the call sequence.

Putting all this together, you can enter the following call progression sequence into the 930A **SEQUENCE SET-UP** display:

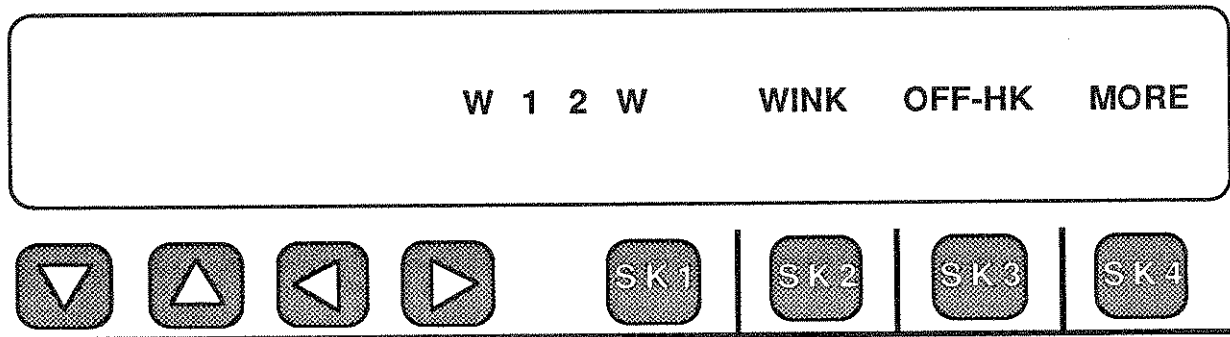

Pressing Softkey 2 inserts a Wink (W). The keypad and the **ENTER** key enter the numbers. The 1 represents the first record in the sequence which should be the **ANI**. The 2 represents the second record in the sequence which should be the **Called Number**. This is the back half of the full Feature Group D sequence which was:

W 1 W 2 3 W

In that case, the first record was the **IC Code**. Now it is no longer there, so the **ANI** becomes the first record. **The form of the Sequence is still the same.**

If you want to check the answer supervision, add an **OFF HOOK** at the end of the sequence so it looks like:

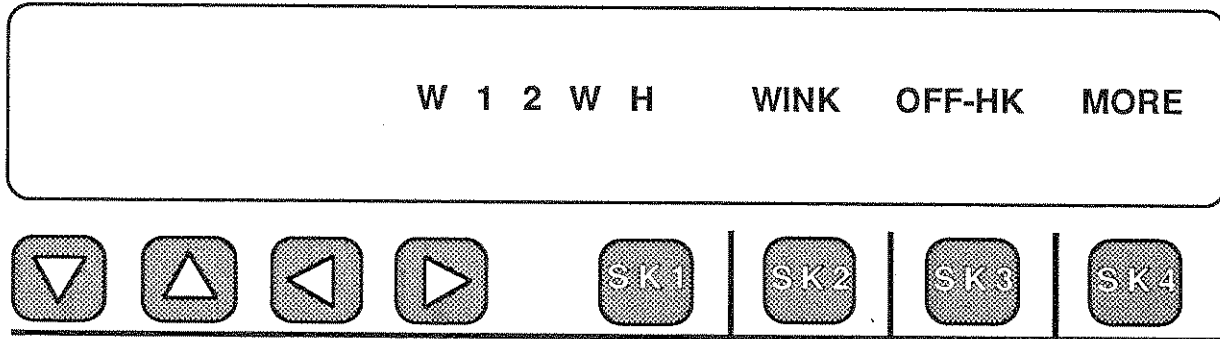

5-4.6 RESPONDER TESTING USING THE DIGIT RECEIVER

With Option 930A-12 and Option 930A-01: **Digit Receiver/Analyzer**, you can set the 930A to be a **Type 100, 102, or 105 Test Line** after a call sequence has been received. After you have set the 930A to the correct **TRUNK TYPE**, you can proceed to the Digit Receiver. **Starting from Menu Option 4** below:

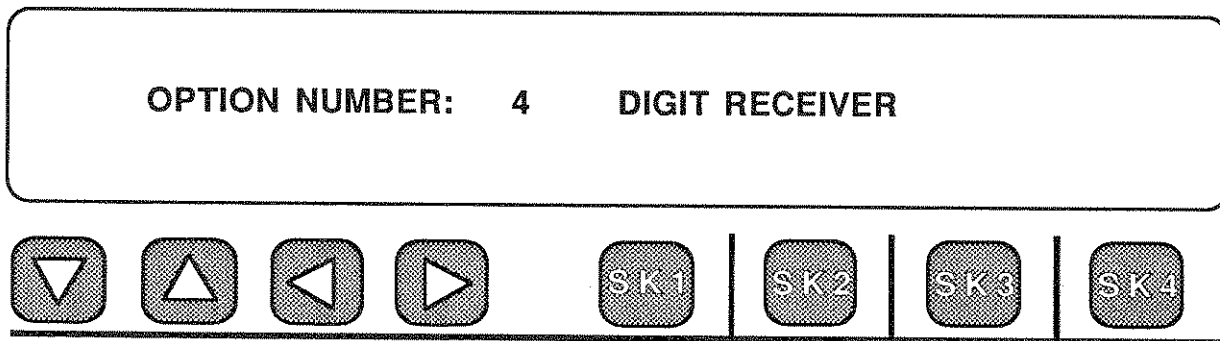

Press any softkey under the display and the main menu will appear:

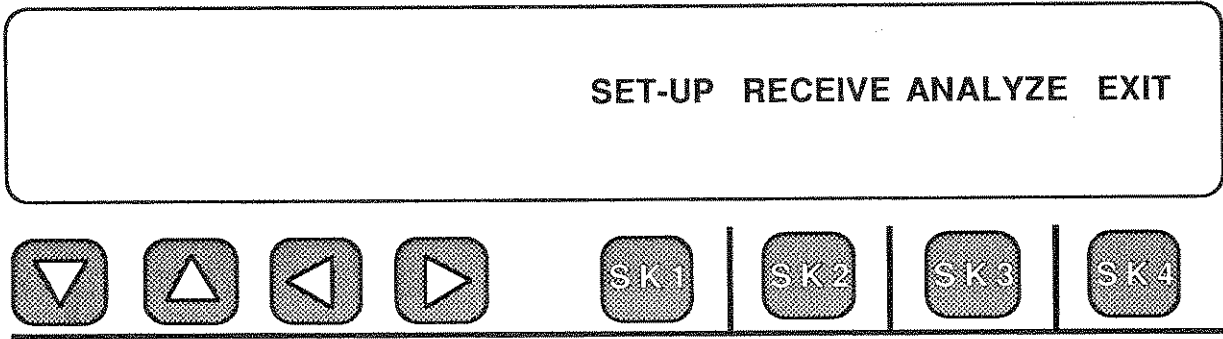

NOTE: To set a TLP other than the default value of 0 dB you must first set the TLP in Menu Option 25 before you set up the Digit Receiver to act as a far end responder.

Remember, you have to set the Digit Receiver up for the expected call and its' parameters.

For this example, we want the 930A to be a Type 105 Far-end Responder after it receives a Touchtone (DTMF) call on a Wink-start Trunk.

First, a single **DTMF** sequence on a Wink Start Trunk is expected. Press Softkey 1 (under **SET-UP**) in the previous display and the **SET-UP** menu will be displayed:

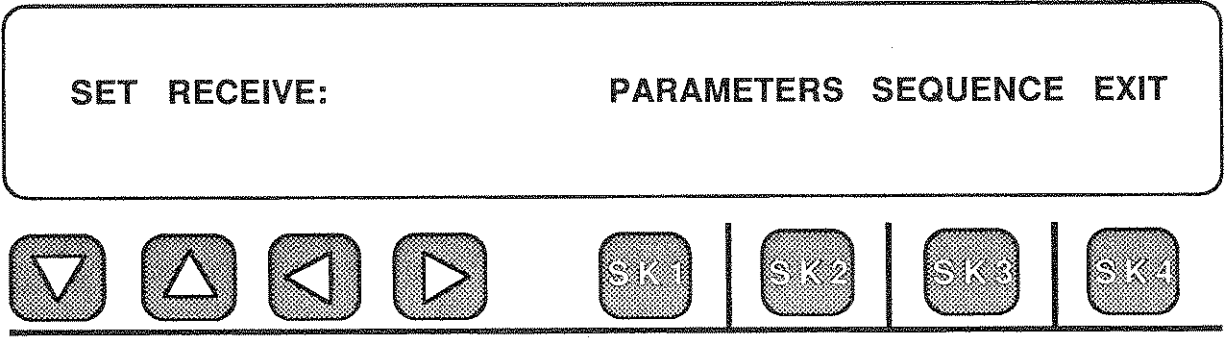

Press Softkey 1 (now under **PARAMETERS**). The display will show the previously entered settings. The 930A default display is shown for example:

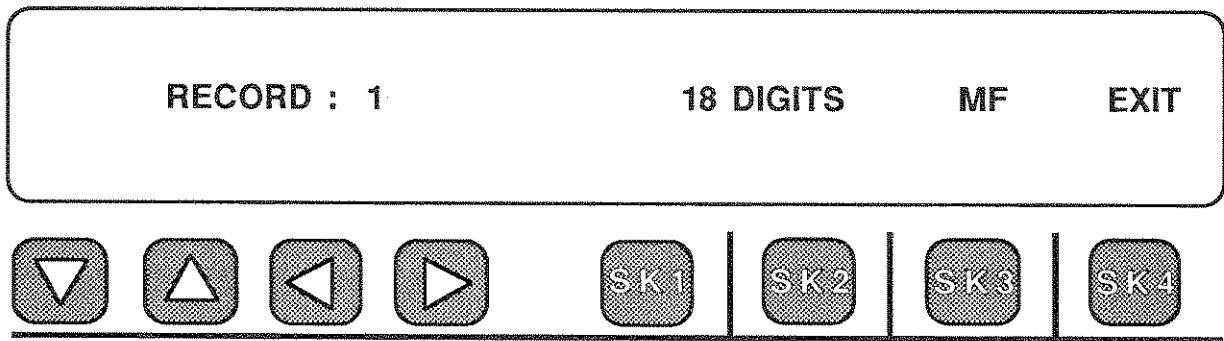

The parameters above must be changed to **DTMF** digits of the correct length. Press Softkey 3 (under **MF**) until **DTMF** appears as shown below:

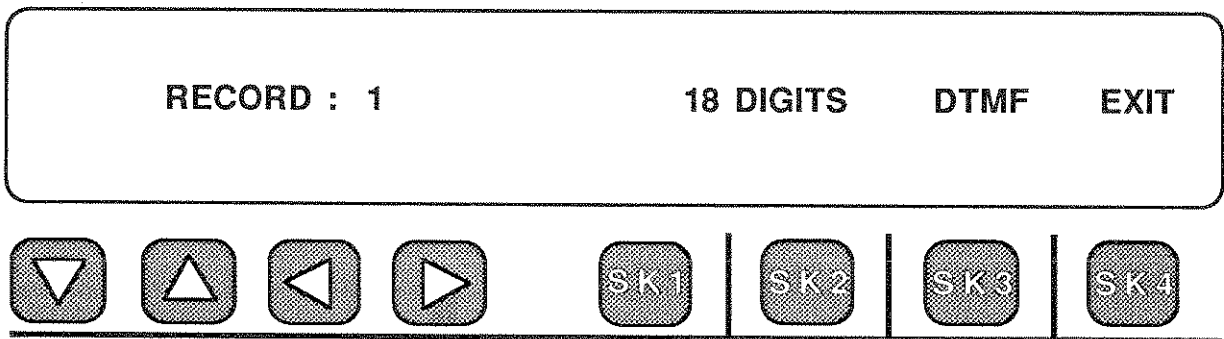

Next, since this is a **DTMF** sequence, the correct length of the expected call must be entered or the 930A will wait for digits that will never come. A local call of 7 digits (no area code) length will do.

Press 7 and then the ENTER key and the display will read:

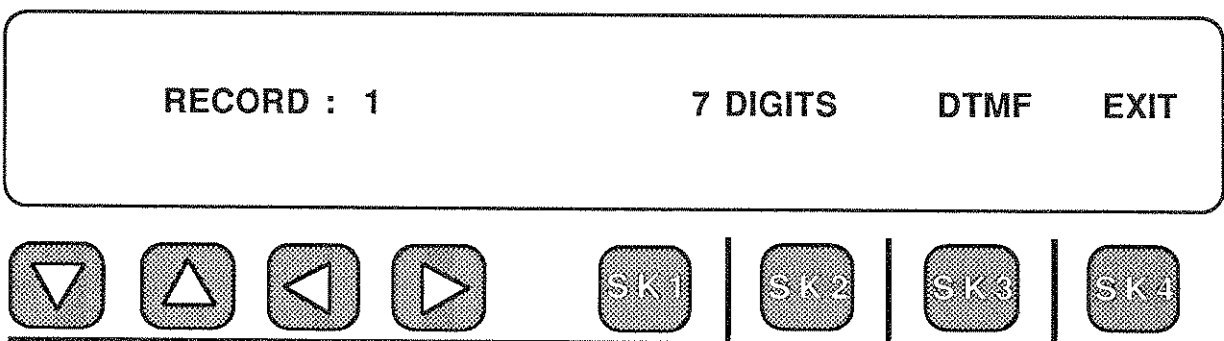

Since only a single record is expected (this is not a Multi-Wink example), there is no need to set up records 2, 3, or 4.

Press Softkey 4 (under **EXIT**) and the main **SET-UP** menu reappears:

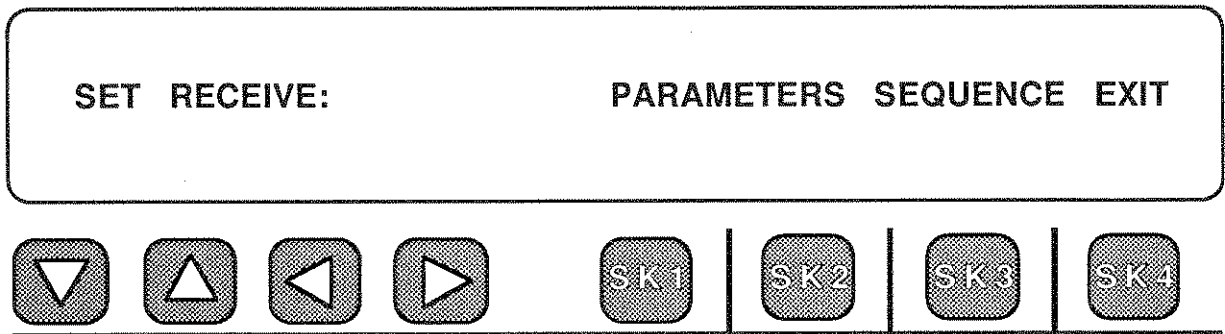

Now you must enter the correct call sequence. To do this, press Softkey 3 (under **SEQUENCE** above) and the 930A display will become:

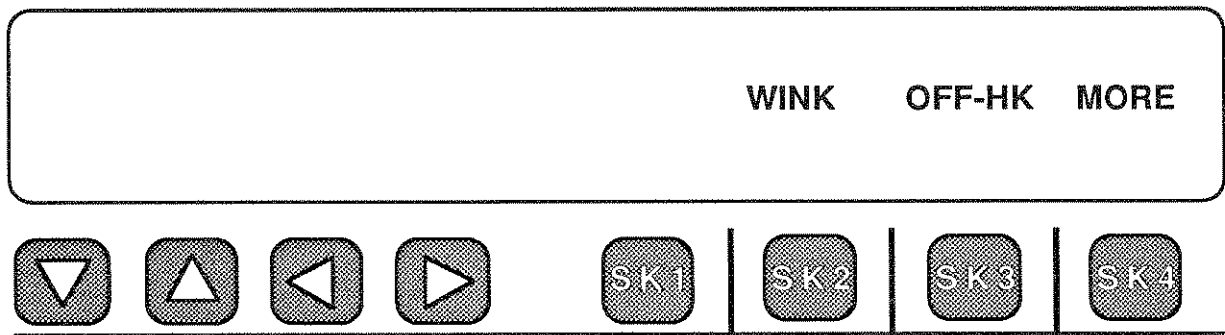

If there is a previously entered sequence present, press the **CLEAR** key to obtain the above display. Remember that, for this example, a Wink Start trunk was specified. This means we have to tell the 930A to provide the Wink, since it is acting as the receiver.

To enter a **Wink** into the sequence, press Softkey 2 (under **WINK**) and the display will become:

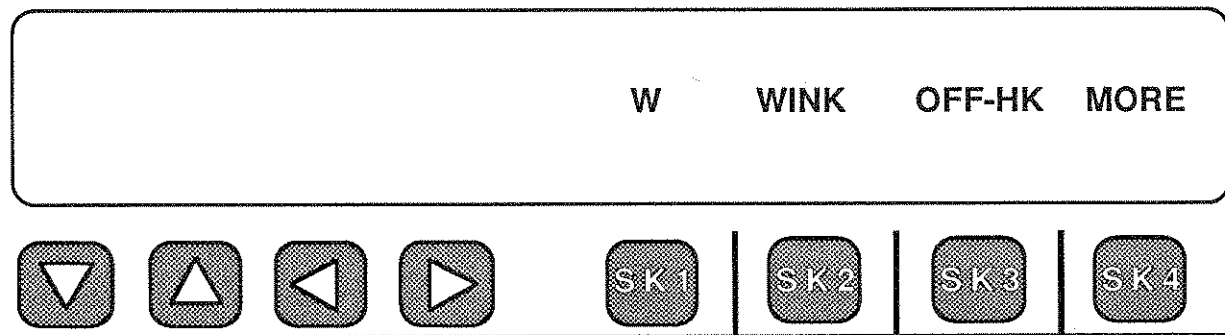

After it gives the Wink, the 930A has to be told to receive one record, or called number. To do this, enter the number "1" into the sequence. Press "1" on the numeric keypad, then press **ENTER**, and the display becomes:

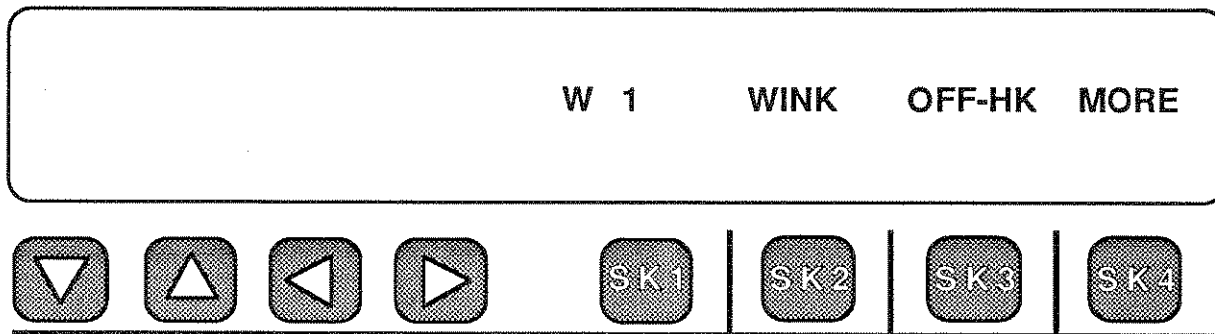

You will now find out what is under the softkey labeled **MORE**. We want the 930A to become a Type 105 Test Line after it receives the call. To do this, press Softkey 4 (under **MORE**) and the 930A display becomes:

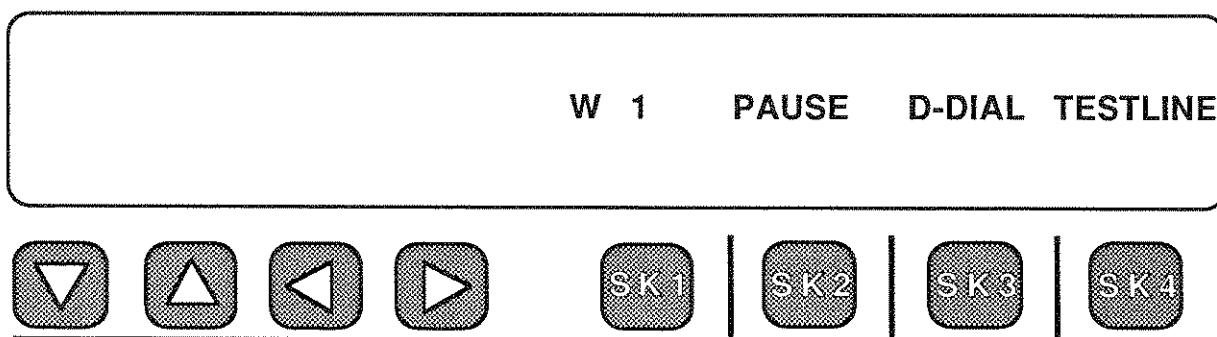

Press **Softkey 4** (under **TEST LINE**) and the 930A display will show the choices:

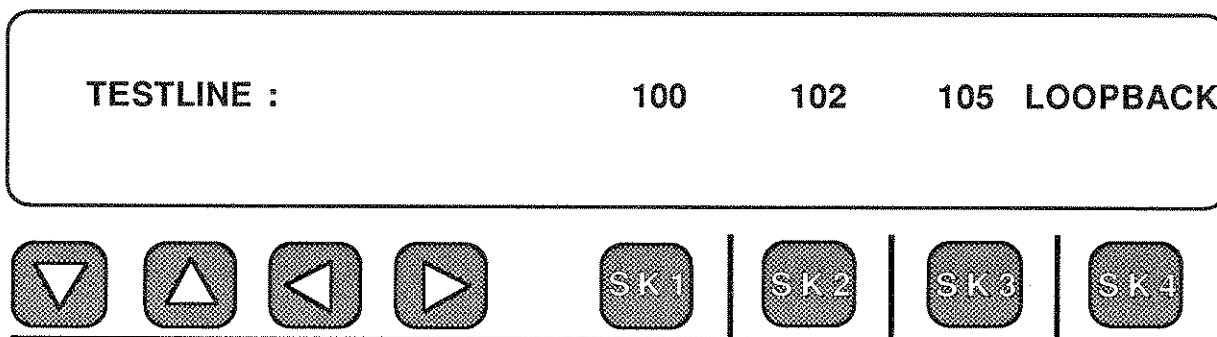

To emulate a **Type 105 Responder** at the end of the received sequence, press Softkey 3 (under **105**) and the 930A display will show:

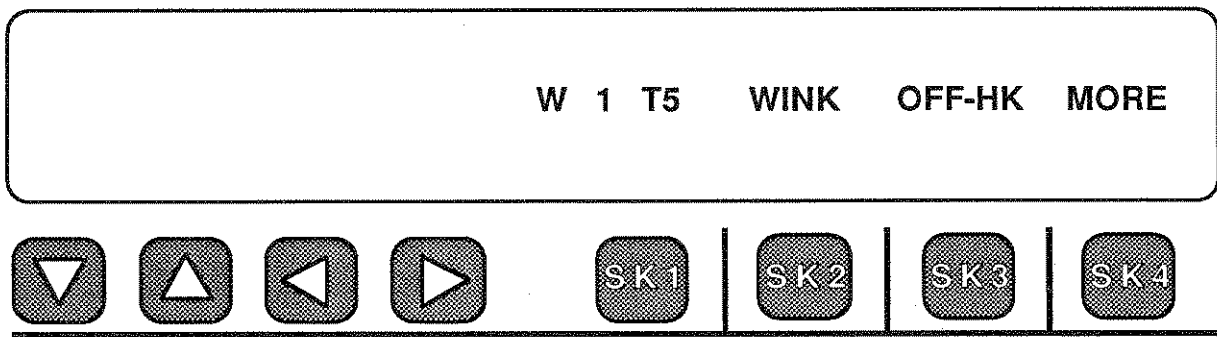

The proper sequence has now been set up. The last step is to place the 930A in the **RECEIVE** mode. Press the **OPTION MENU** key to return to the **SET-UP** menu shown on the following page.

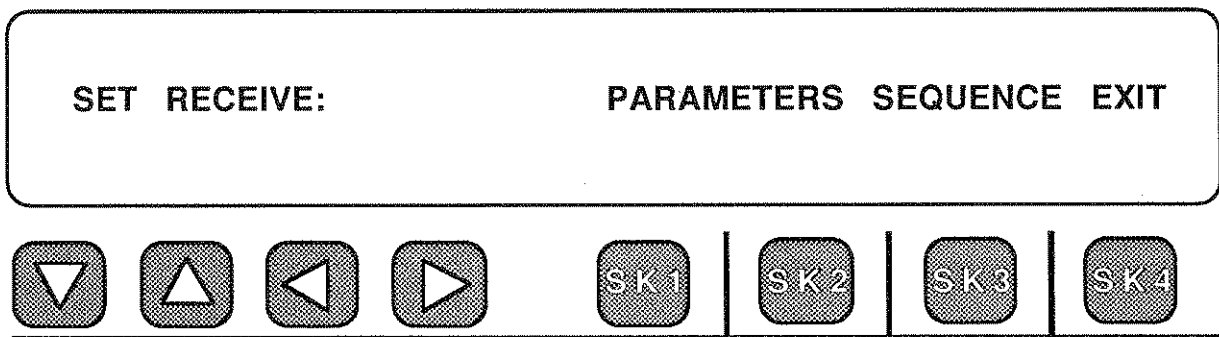

Press Softkey 4 (under **EXIT**) or the **OPTION MENU** key to return to the main menu:

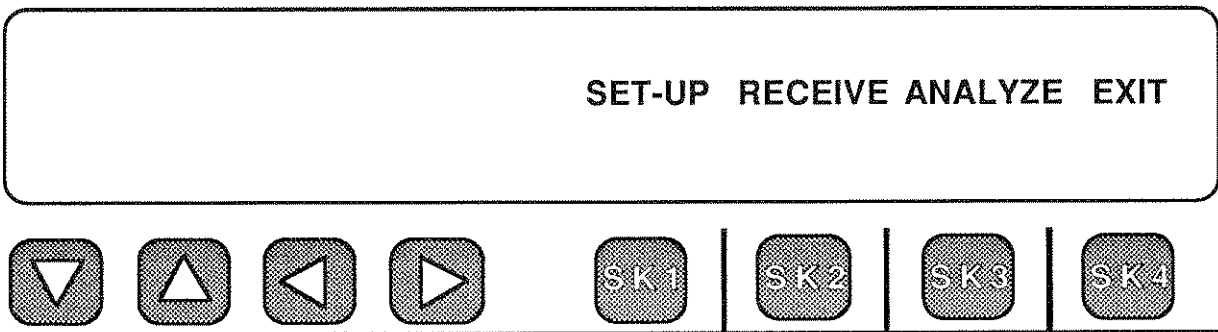

Press **Softkey 2** (under **RECEIVE**) to select the Digit Receiver mode of operation. The 930A display will appear as shown below:

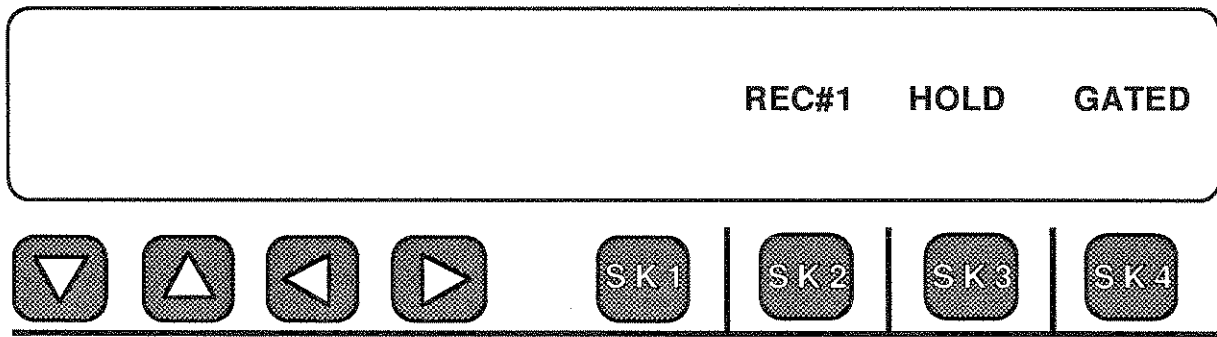

When the 930A sees a seizure of the trunk it will respond with a Wink. Then it will expect to receive a digit string (**DTMF** digits in this example) which will be displayed across the screen. After the digit string has been received the 930A will emulate a Type 105 Test Line until the distant end goes back **On Hook**.



CAUTION

THE RING GENERATOR CAN PRODUCE
POTENTIALLY DANGEROUS VOLTAGE LEVELS.
DO NOT TOUCH TEST LEADS WHILE GENERATOR IS OPERATING.

5-5 THE RING GENERATOR AND REN-3 LOAD (MENU OPTION #5)

The 930A may be equipped with a Ring Generator and Ringer Equivalent Number 3 Load by installing Option 930A-13. This option provides a nominal sinewave ringing voltage of 87 Volts RMS at 20 Hz. The **ringing voltage** level, **ringing frequency** and **ON/OFF** times are adjustable. A true Ringer Equivalent Number 3 (**REN-3**) load is also provided (Menu Option 5) to terminate ringing supplies. The Ring Generator is intended for operation on 2- and 4-wire Loop and Ground Start trunks.

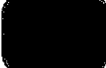
The following steps outline the set-up and operation of the Ring Generator.
To begin:

Press the DIAL/RING   Dial/Ring function key.

An example of a typical 930A display in **DIAL/RING** mode is shown below:

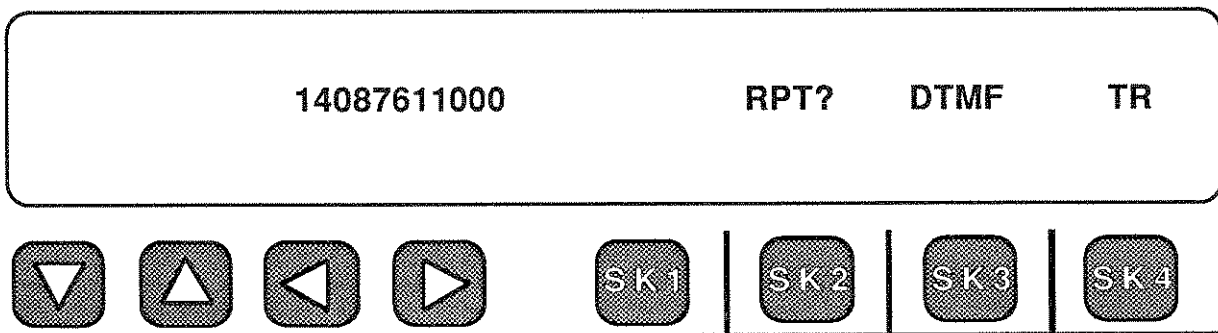

The 930A "remembers" the last settings, and in this example, the last thing done in **Dial/Ring** was to send the **DTMF** call shown. **To select the Ring Generator**, press Softkey 3 (under **DTMF** in the above display) until the following display appears.

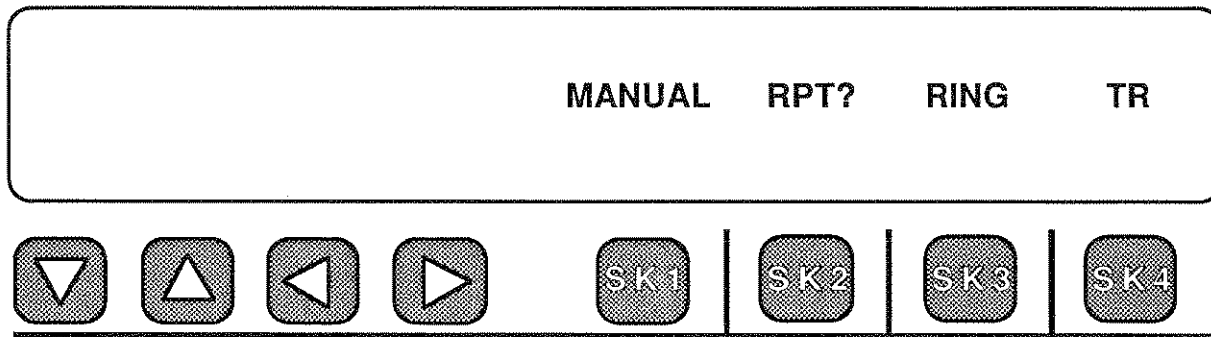

To cause **RINGING** at the Tip/Ring jack, press Softkey 1 (under **MANUAL**) and the voltage will remain as long as Softkey 1 is held down.



To cause **Intermittent Ringing** continuously at the T/R jack, press Softkey 2 (under **RPT?**).

To return to the **DIAL** mode of operation, press Softkey 3 (under **RING**). Softkey 4 is inactive.

5-5.1 MEASURING RINGER VOLTAGE AND FREQUENCY USING THE REN-3 LOAD

To make the 930A act as a **Ringer Equivalent Number 3 (REN-3)** load, perform the following steps:

Press the **OPTION MENU**  **Option Menu** function key.

Use the **UP/DOWN**   arrow keys to select Menu Option 5: **REN-3 LOAD**.

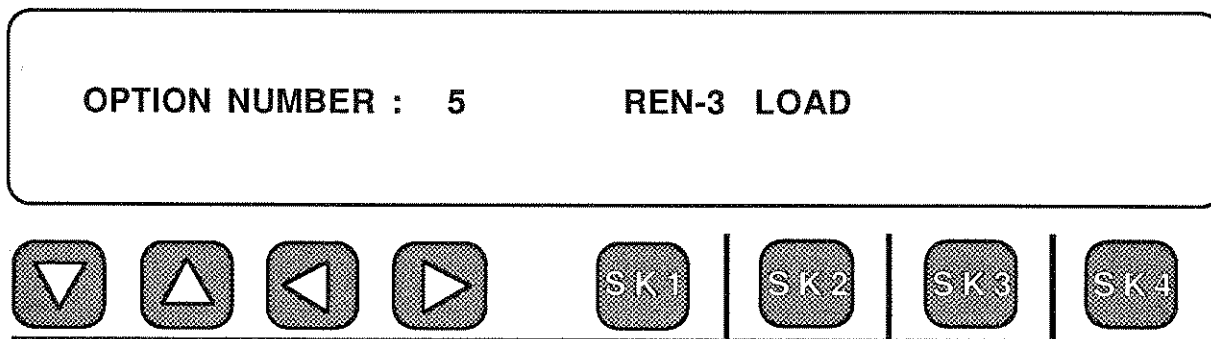

If you have selected 2-wire LOOP or GROUND START Trunk Type, the 930A display will first appear as shown below when you press any softkey:

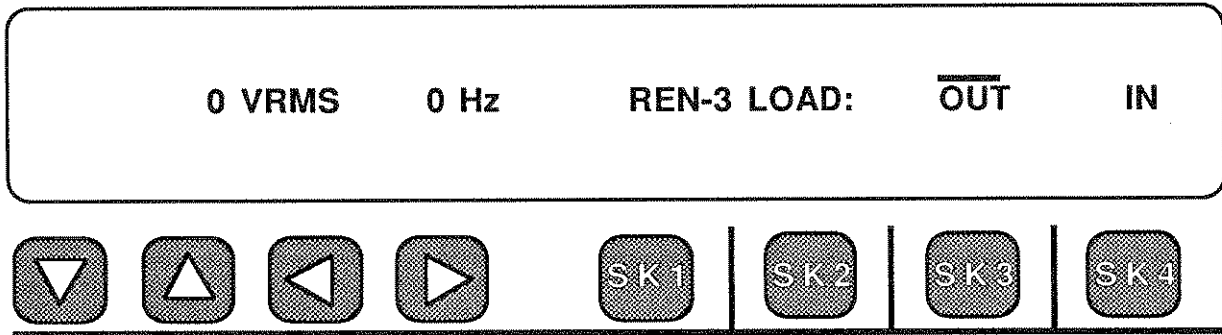

In this example, the **REN-3 Load** is not on-line (as shown by the cursor above **OUT**). To have the 930A act as a true **REN-3 Load** at its TR or T1R1 jacks, press Softkey 1 (under **IN**). The 930A display will change to the one on below:

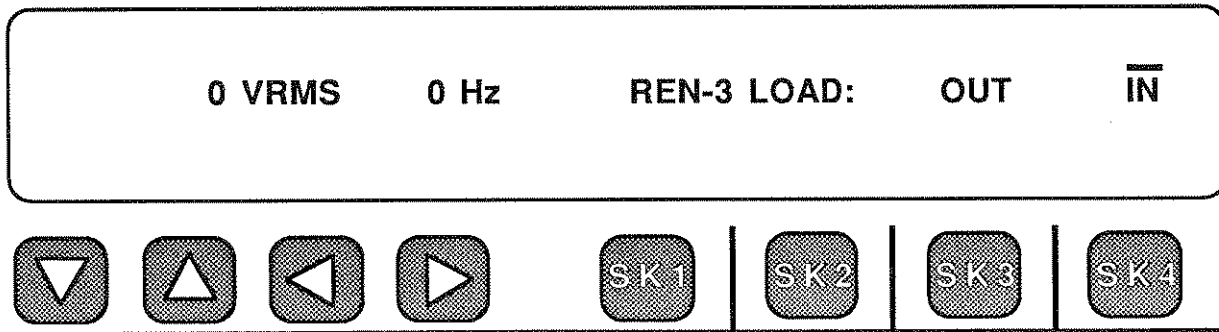

If you have selected a 4-wire Trunk Type, there is no display of the level and frequency of the Ringing.

When Ringing does come into the 930A on a 2-wire Trunk, the display will show the voltage level in RMS volts and the frequency in Hertz. A sample display is shown below:

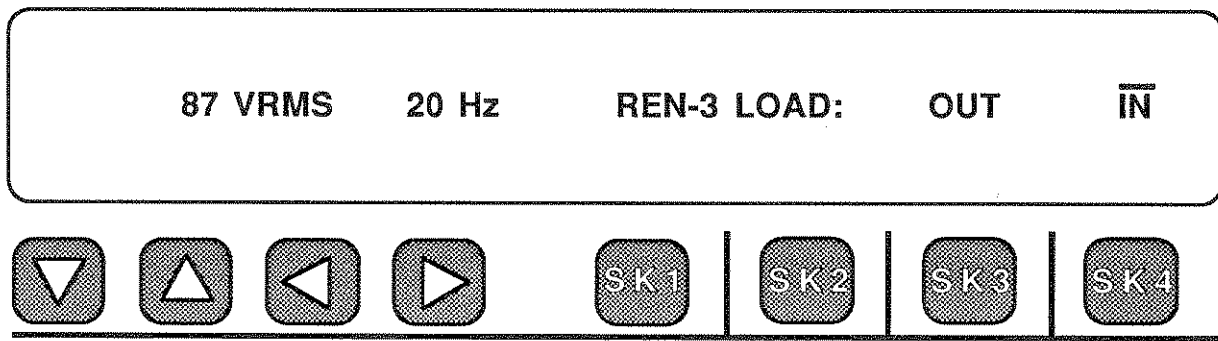

The 930A must be providing the load to make these measurements.

You can leave Menu Option 5 at any time by pressing the **OPTION MENU** key or any other function key. If you have selected **IN**, then the 930A will put a (3) Ringer Equivalent load on the line while you make other measurements. The default condition for this Menu Option is **OUT** or **OFF LINE**.



5-6 HOW TO USE THE DC VOLT/AMP METER (MENU OPTION 6)

Menu Option 6: **DC VOLT/AMP METER** provides you with a DC voltage and current measuring capability on metallic (analog) trunks. This function is most useful for determining the levels of supervision voltages and currents on a loop.

You can measure the DC voltage from Tip-to-Ground, Ring-to-Ground, and Ring-to-Tip on **2-wire Loop and 2-wire Ground-Start trunks**. The DC voltage from TR-to-Ground, T1R1-to-Ground and TR-to-T1R1 may be measured on **4-wire Loop and 4-wire Ground-Start trunks**. On **E&M trunks**, you can measure the DC voltage from E-to-Ground and M-to-Ground. All voltage readings are printed as signed values to the nearest volt. This feature may be used in either **TERM** or **BRIDGE** mode. You can measure **DC current on 2- and 4-wire Loop and Ground Start trunks** when the 930A is set to the **CONTACT** mode and terminates the trunk.

To measure DC voltage or current on a 2-wire Loop Start trunk:

Press the OPTION MENU  Option Menu function key.

Use the UP/DOWN   arrow keys to select Menu Option 6: DC VOLT/AMP METER.

The 930A display will be:

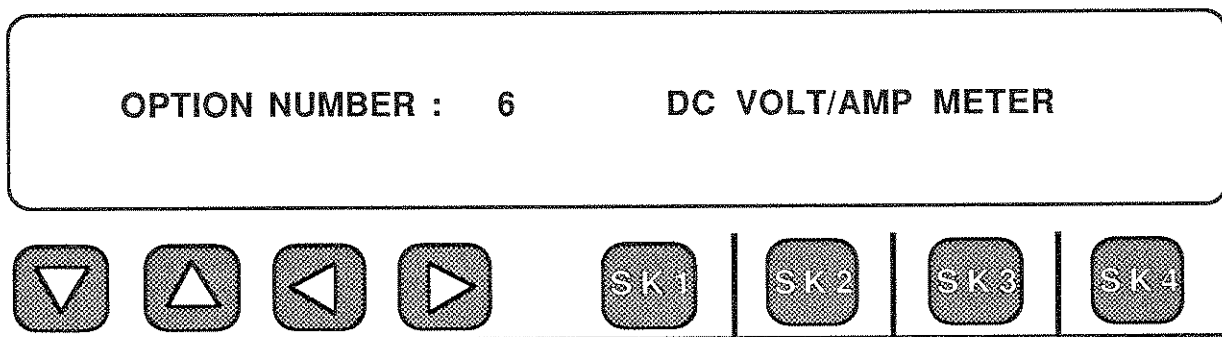

Press any softkey under the display and you will see the menu:

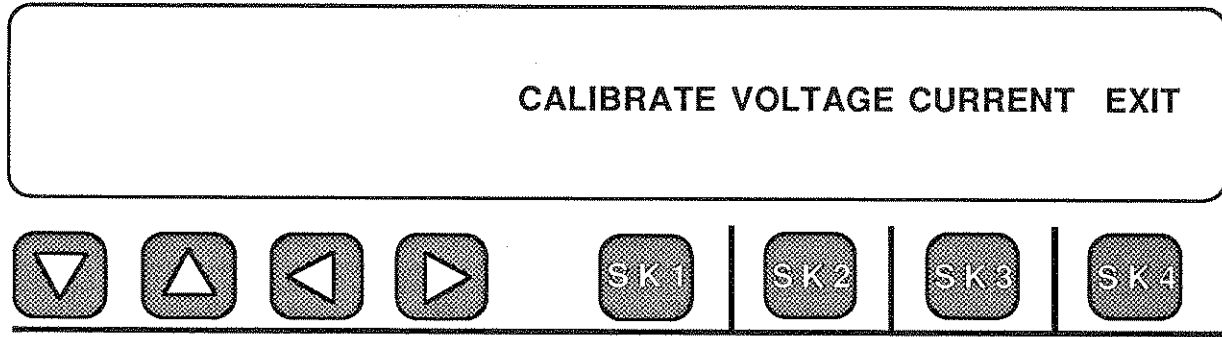

Press the softkey under the measurement you wish to make, or press Softkey 1 under **CALIBRATE** to make the 930A calibrate itself prior to making a measurement. Press **CALIBRATE** prior to any current measurements.

To measure **DC Voltage**, press Softkey 2 under **VOLTAGE** and you will see a display similar to:

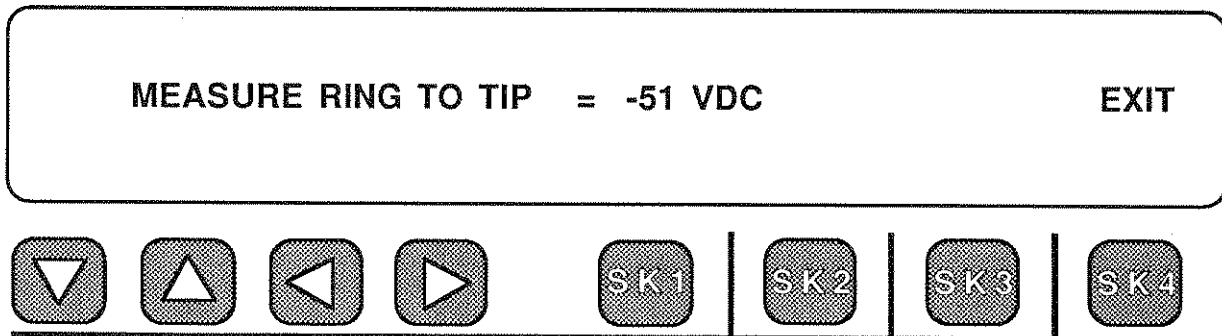

In this case, the contact side of the circuit is **ON HOOK** because the voltage is high. If the contact side goes **OFF HOOK** then a lower reading will be expected as current is drawn through the loop and voltage drops occur. A typical Ring-to-Tip voltage, after the contact side goes **OFF HOOK**, might be less than -45 volts.

To measure the voltages from **Ring-to-Ground** and **Tip-to-Ground** under **ON** and **OFF HOOK** states, press Softkey 1 and the display will scroll to the next state.

An example of a typical Ring-to-Ground measurement if the contact side goes **OFF HOOK** is shown below:

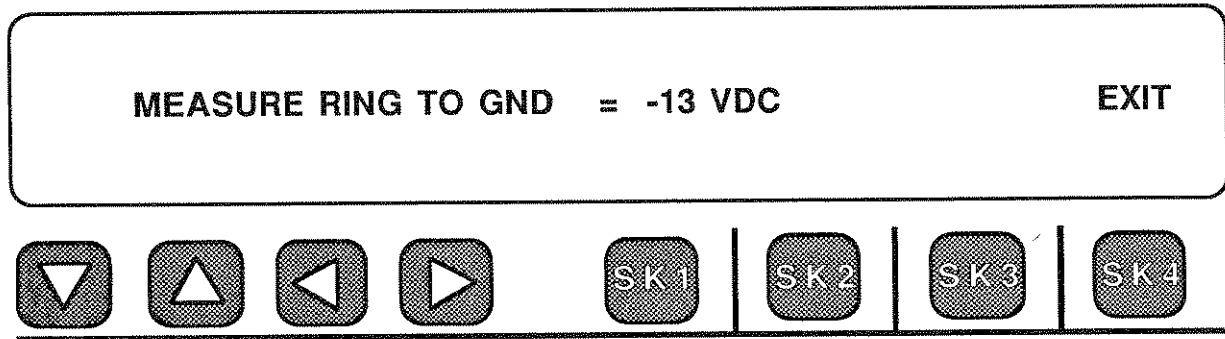

Pressing Softkey 1 advances the 930A to measuring the Tip-to-Ground voltages. An idle state (both sides **ON HOOK**) should give the following display:

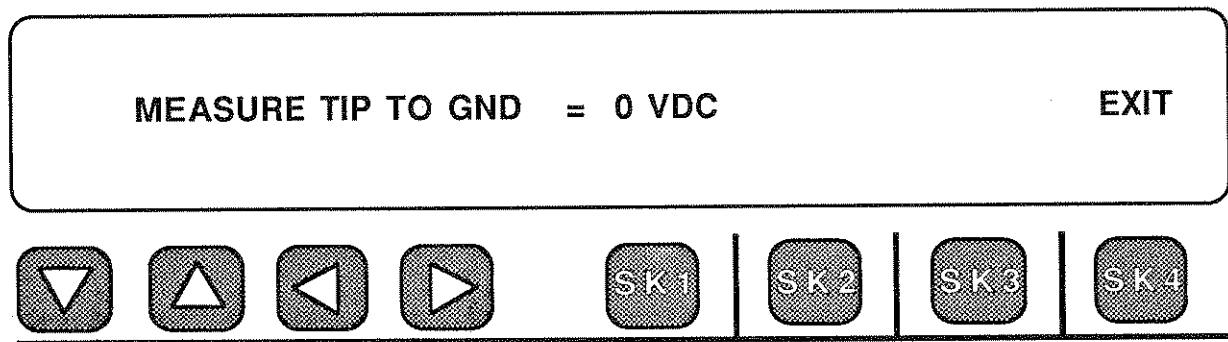

This is the proper indication for a Loop Start trunk in the idle state. When the battery side goes **OFF HOOK**, a typical display of Tip-to-Ground voltage would be:

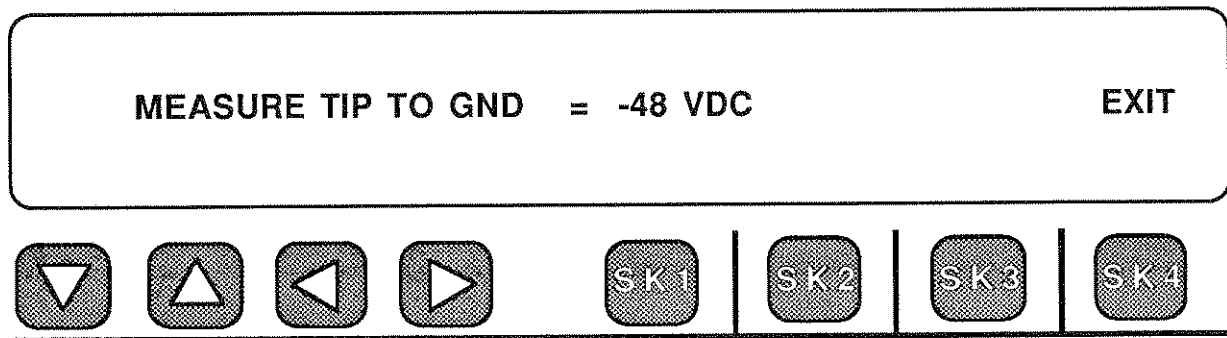

This indicates a battery reversal. Unless these or similar readings were obtained, there would be an indication of trouble in the loop supervision circuitry. Press Softkey 4 under **EXIT** to return to the main menu.

The following table lists the range and accuracy of the various 2-wire and 4-wire DC Voltage measurements the 930A can make.

| | <u>RANGE</u> | <u>ACCURACY</u> |
|-----------------------------------|----------------|-----------------|
| Tip-to-Ring and TR-to-T1R1: | +60.0 to -60.0 | +/- 1 volt |
| Tip-to-Ground and Ring-to-Ground: | +0.0 to -60.0 | +/- 1 volt |
| TR-to-Ground and T1R1-to-Ground: | +0.0 to -60.0 | +/- 1 volt |
| M-to-Ground and E-to-Ground: | +0.0 to -100.0 | +/- 1 volt |

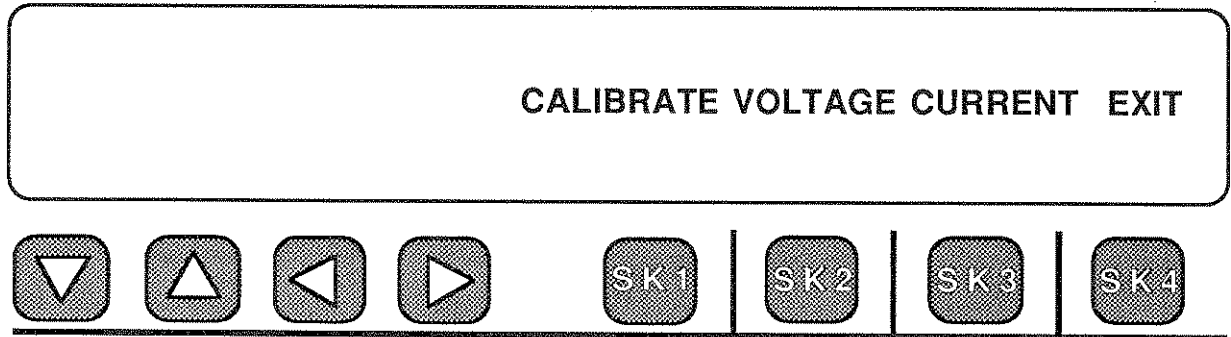

To measure DC current, the 930A Trunk Type must be set for 2- or 4-wire Loop or Ground Start, CONTACT and Terminate operation. Prior to measuring the current, you should remove the test cords from the 930A and press Softkey 1 under **CALIBRATE** in the main menu shown above. After calibrating the 930A you may then reconnect the test cords.

Press Softkey 3 under **CURRENT** in the main menu and the loop current measurement will be displayed. A typical display would look like:

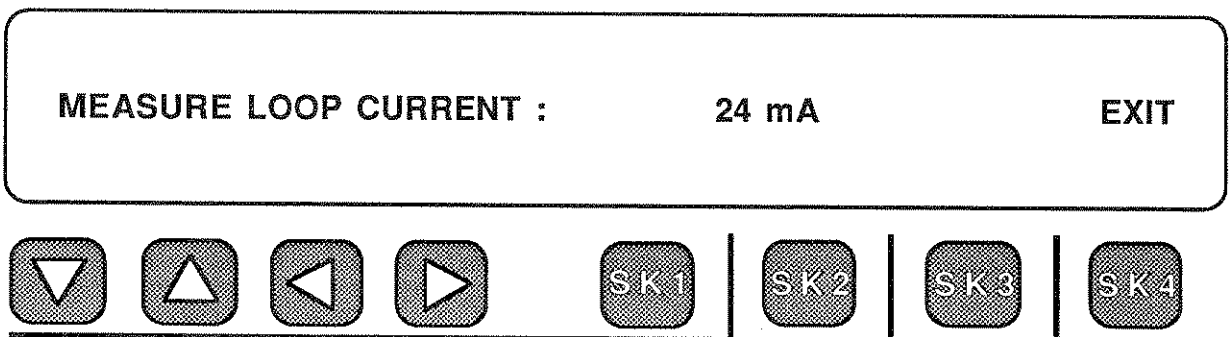

Error messages are provided if you try to measure a parameter without having the Trunk Type correctly set up.

5-7 HOW TO CHANGE THE SUPERVISION VOLTAGE THRESHOLDS (MENU OPTION 7)

The 930A was designed to send and receive -48 VDC supervision which is the most common form. That is, **ON HOOK** or **OFF HOOK** supervision status on Loop Start, Ground Start, or E&M trunks is represented by a voltage level between 0 and -48 VDC. For example, an **ON HOOK** state might be -48 VDC while an **OFF HOOK** state might be -30 VDC. This happens because the **On Hook** state is an open loop or idle condition with no load and no voltage drops, while the **Offhook** condition is a closed loop with current being drawn, and consequently lower voltage.

At the end of very long loops, or when you are working on systems powered from -24 VDC, you may need to change the threshold voltage settings on the 930A in order to make the front panel supervision LEDs function properly, and to allow functions like the Digit Receiver/Analyzer (Option 930A-01) to operate. This is the purpose of Menu Option 7.

IMPORTANT NOTE

You can only change the threshold of the voltage which the 930A will recognize at its input. You cannot change the level of the supervision voltage which the 930A supplies at its output. This is fixed at 48 volts.

If you are unsure of the levels on your trunk you should first measure the voltage levels of the **ON** and **OFF HOOK** states using Menu Option 6: **DC VOLTMETER**. Once you have determined what the voltages are you can go to Menu Option 7 and reset your thresholds accordingly.

Usually the tip off that you need to change thresholds comes from the front panel supervision LEDs. These may flicker, or they may not be lit at all, if the proper voltages are not present. If you have selected the correct trunk type for the 930A and connected it to the trunk under test and the LEDs do not indicate properly, then you should check the voltages on the trunk with the DC Voltmeter.

Some understanding of trunk supervision circuits is necessary to make use of this feature successfully. It is **not** normally necessary to use this Menu Option when operating the 930A.

The choices presented in this Menu Option will vary, depending upon the current trunk type and which end of the circuit the 930A is on. In all cases however, a series of screens are presented showing a voltage level, a description of the supervision state this represents, and a **DEFAULT** choice. To change the displayed level, enter a new value using the numeric keypad. To select the default level, press the softkey labeled **DEFAULT**. To accept the currently displayed value, press any other softkey. Once all the thresholds have been set, the 930A will return to the Option Menu display.

In all cases, "**ORIG**" refers to the end of the circuit the 930A is on. If the 930A trunk type is set to Loop Contact, for example, "**ORIG OFFHOOK**" means the contact side of the circuit is Offhook. If the 930A is providing battery, "**ORIG OFF HOOK**" means the battery side of the circuit is Off Hook. Voltage levels are printed as absolute values: "**< 45V**" does **not** mean "more negative than -45 Volts;" it means "less than 45 Volts of potential." Values can be set to the nearest volt with an accuracy of +/- 0.5 VDC. Use Menu Option 06: **DC VOLTMETER** to examine the current voltage levels.

5-7.1 SUPERVISION THRESHOLD RANGES

This section provides a graphic presentation of the various supervision threshold ranges and their corresponding indications.

LOOP START SUPERVISION

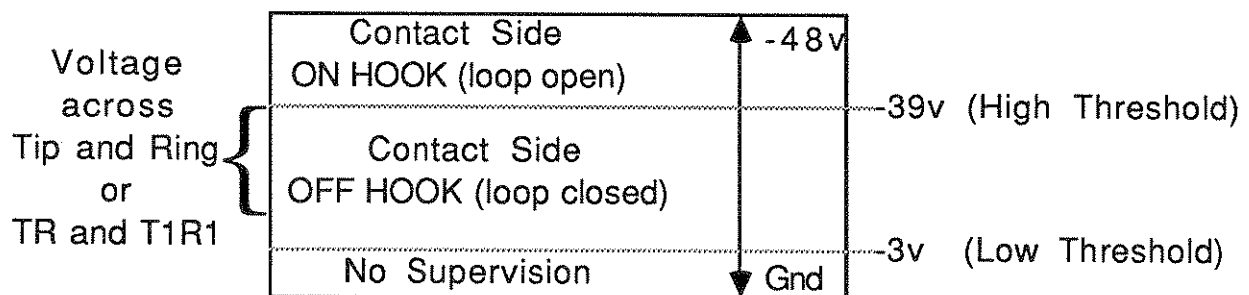

This shows the **ON** and **OFF HOOK** indication states of the supervision LEDs for the default setting of Ring-to-Tip voltage thresholds. Voltages above 39 volts will cause an **ON HOOK**, and voltages above 3 VDC and below 39 VDC will cause an **OFF HOOK**. A reversal of -48 Volts and ground would indicate the battery side **OFF HOOK**.

GROUND START SUPERVISION

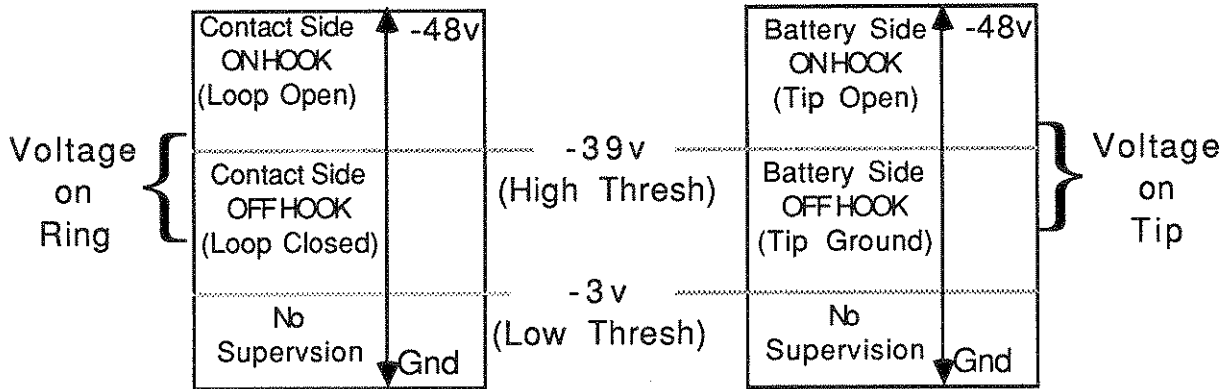

This provides a description of the **ON** and **OFF HOOK** supervision states at each end of a Ground Start circuit with the default thresholds. Voltages on Ring above 39 Volts indicate **ON HOOK** at the **CONTACT** side. Voltages on Tip in excess of 39 Volts indicate **ON HOOK** on the **BATTERY** side.

E&M SUPERVISION

Originating end (**SEND-M**) indications:

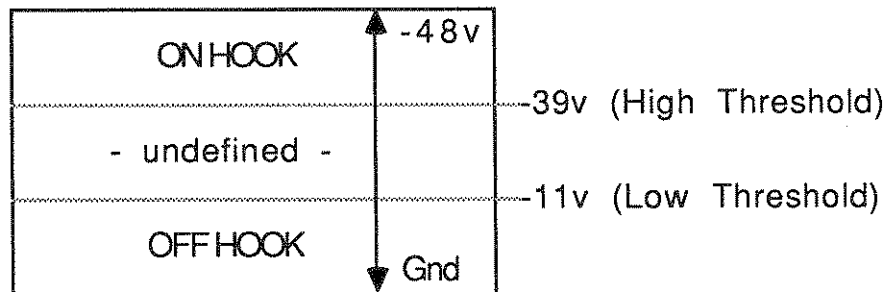

Here, the **ORIG** LED shows the status of the M-Lead. The **TERM** LED shows E-Lead status. An **OFF HOOK** indication is provided if the voltage is below 11 Volts. The LEDs will not be lit for voltages below 39 Volts but above 11 Volts. The LEDs show an **ON HOOK** if the voltage is greater than 39 Volts.

Terminating end (**SEND-E**) indications (use the same diagram above):

In this case, the **ORIG** LED shows the status of the E-Lead. The **TERM** LED shows M-Lead status. The LEDs do not light for voltages below 39 Volts and above 11 Volts. The LEDs will indicate an **OFF HOOK** if the voltage is below 11 Volts. The LEDs will indicate an **ON HOOK** for a voltage above 39 Volts.

5-7.2 HOW TO WORK WITH 24 VOLT SUPERVISION



Rather than try to explain, in general terms, how to change supervision thresholds, it will be more useful to take the most common reason for changing them from their defaults, and give examples for each trunk type. The following sections outline the procedure for setting Loop Start, Ground Start and E&M trunk supervision thresholds to accommodate 24 VDC supervision instead of the normal 48 volts.

5-7.3 HOW TO CHANGE LOOP SUPERVISION THRESHOLDS

To look at dialed digits on a 2-wire Loop Start PBX trunk which uses 24 VDC supervision, you will need to use Menu Option 7. The following example will give you an idea of how this Menu Option works.

After setting the 930A to **LOOP NORMAL** Trunk Type, and simulating a 2-wire, 600 or 900 ohm circuit's originating (**CONTACT**) end, perform the following steps to adjust the supervision thresholds.

Press the OPTION MENU  Option Menu function key.

Use the UP/DOWN   arrow keys to select Menu Option 07: SUPERVISION THRESHOLDS.

The 930A display will appear as shown below:

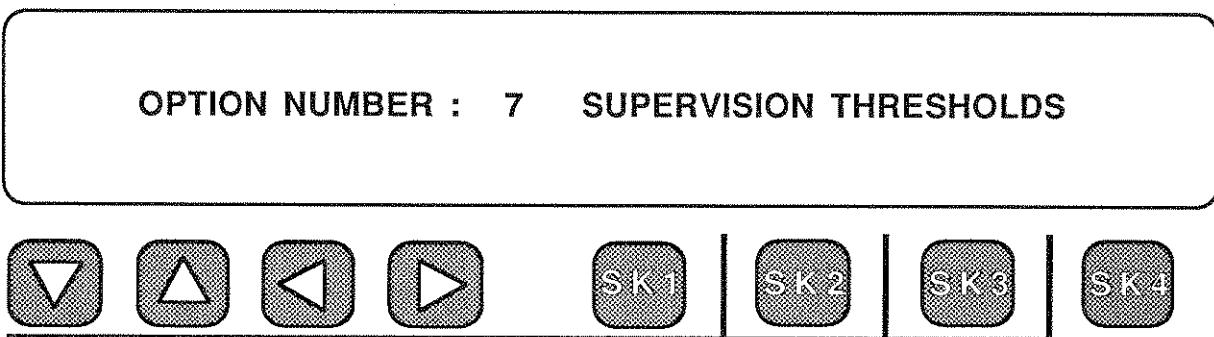

Press any softkey to enter the menu option and the display will appear as:

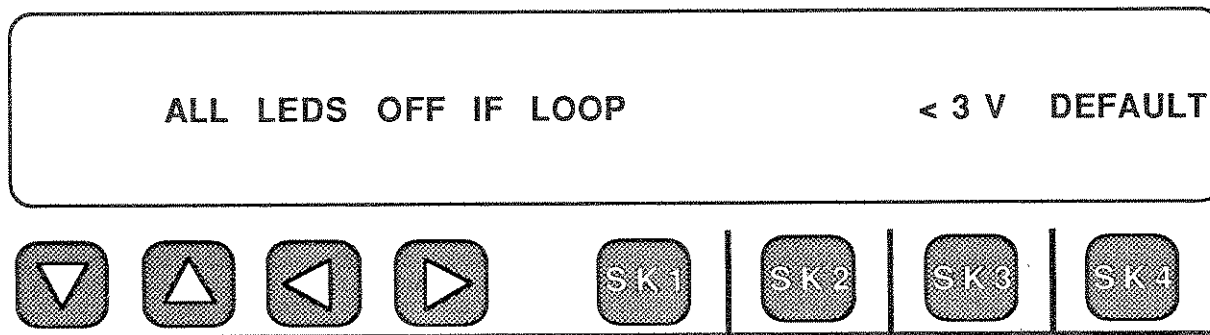

The display above means that if there is no talk battery present ("Dry" loop), there will be no voltage across the loop, and the 930A will turn off all supervision LEDs. This threshold is preset at 3 Volts. For this example, this value will be adequate. Advance the display to the next choice by pressing either Softkey 1, 2, or 3 to bring up:

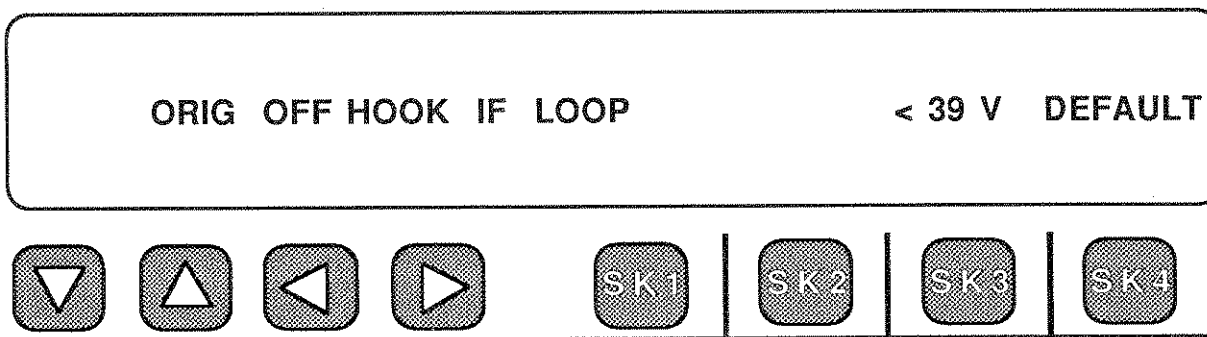

When the originate, or **CONTACT**, side of the circuit goes **OFF HOOK**, it closes the loop between Tip and Ring (2-wire) or TR and T1R1 (4-wire). This lowers the voltage difference across the loop. On a short loop, or near the contact end of the circuit, this voltage will be very small. Near the battery (Central Office) end on a long loop, this voltage can remain fairly large. The 930A sees the **CONTACT** end as being **OFF HOOK** when the voltage across the loop falls below 39 Volts. If a PBX is being tested and it is powered from -24 Volts instead of -48 Volts, then the threshold of the 930A should be set to about 20 Volts.

To set the threshold to 20 Volts, use the keypad to enter the number **20**, and press the **ENTER** key. This value will now be remembered by the 930A so you will have to press the **DEFAULT** key, in the above display, when you have finished testing, or you will encounter strange readings when you go back to normal 48 Volt trunks.

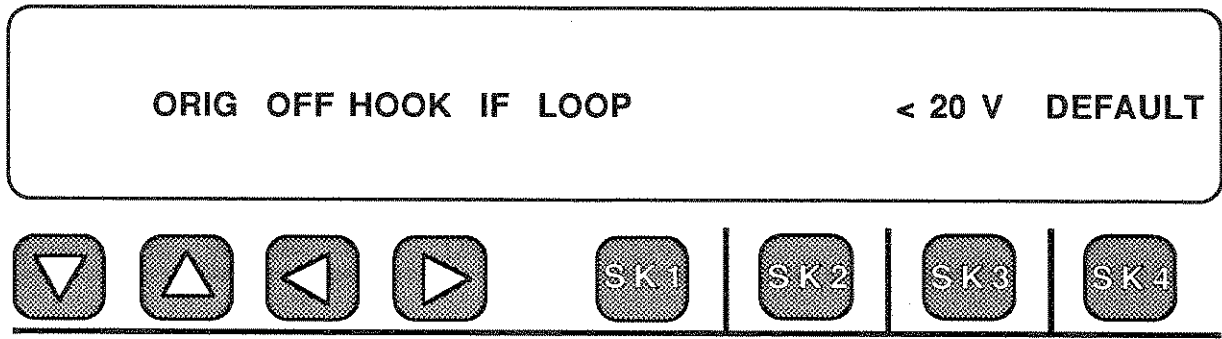

After you have set in the 20 Volt level, press the **OPTION MENU** function key to exit from this menu.

IMPORTANT NOTE: If you press either Softkey 1, 2, or 3 instead of pressing the **OPTION MENU** key and exiting, you will be asked to select whether you want the 60 Hz filter on or off. Most times, the answer is **ON**. You turn the filter **ON** and this is the default. However, if you are receiving Dial Pulse digits, then you would turn this filter **OFF**. The display is:

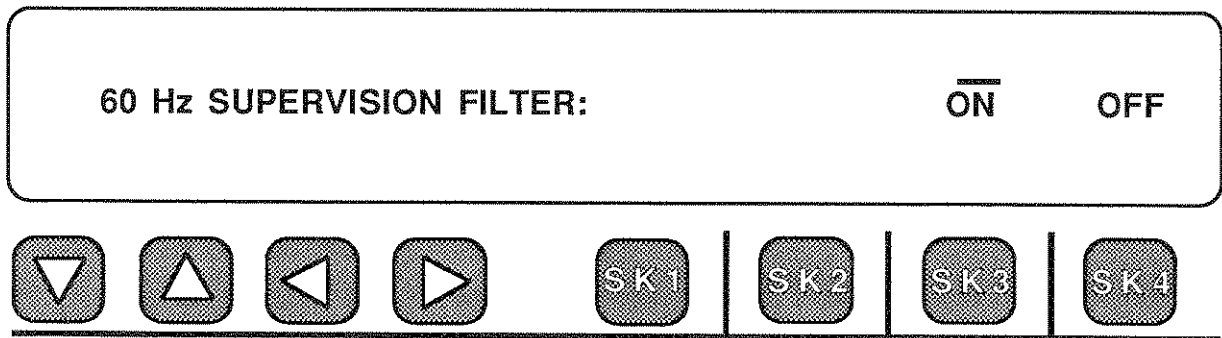

If you had set the Trunk Type to simulate the Central Office, or **BATTERY** end of the circuit, the only difference in the procedure would be that the display below would have appeared as a reminder

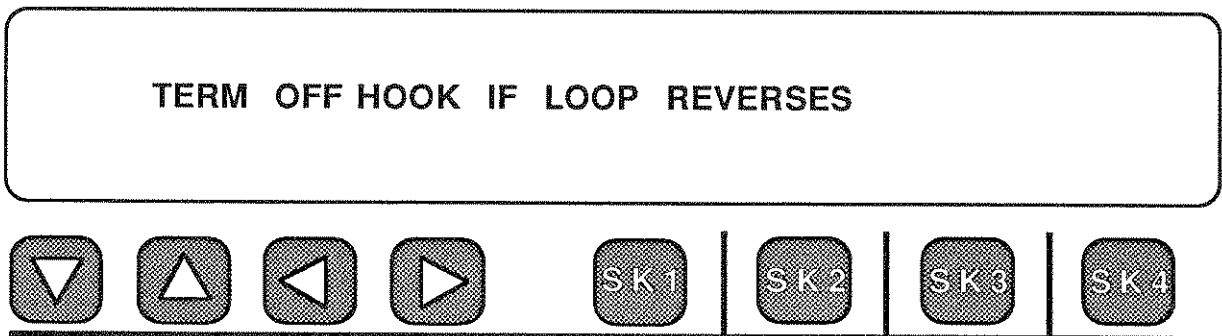

and the threshold display would read **TERM OFF HOOK IF LOOP <39 V**. The procedure for changing the threshold to 20 Volts would be the same.

The previous display explains that the 930A expects the **BATTERY** (Central Office) side of a loop start circuit to provide -48 VDC on Ring (**2-wire**) or T1R1 (**4-wire**) in **NORMAL** mode. In **LOOP REVERSE**, the 930A expects to see -48 VDC on Tip (2-wire) or TR (4-wire). The 930A interprets this as the normal **ON HOOK** condition. A reversal from - to + is interpreted as the **BATTERY** side of the circuit being **OFF HOOK**. There is no voltage threshold.

Essentially, Menu Option 7 enables you to adjust the supervision voltages so the front panel LED supervision indicators will read properly under unusual circumstances.

IT DOES NOT MEAN THAT THE 930A WILL OUTPUT OTHER THAN -48 VDC SUPERVISION, MERELY THAT IT WILL RECOGNIZE OTHER VOLTAGES AT ITS INPUT.

5-7.4 HOW TO CHANGE GROUND START THRESHOLDS

For this example, assume a 2-wire 900 ohm, **NORMAL** Ground Start trunk type has been selected on the 930A. Further assume that the 930A is in **CONTACT** mode simulating the originating end of the circuit.

The following describes normal 2-wire trunks. For **REVERSE** circuits, Tip and Ring are interchanged. On 4-wire circuits, TR replaces Tip and T1R1 replaces Ring.

After selecting Menu Option 7 and pressing a softkey to enter the menu as previously described in Section 3-10.5.3, the 930A display will be:

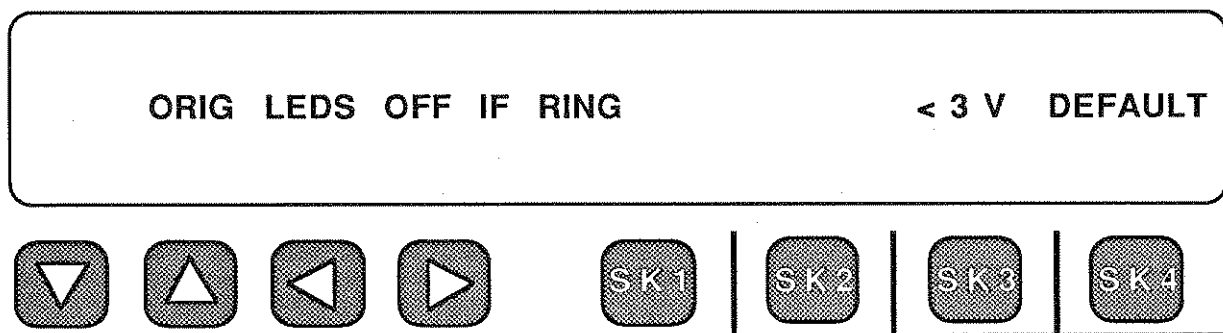

As before, this display explains that if there is no talk battery detected, there will be no voltage on Ring and the 930A will turn off the supervision LEDs on the contact side. The preset voltage threshold is 3 Volts. If you wanted to change this value you could simply enter the desired number from the numeric keypad and press the **ENTER** key. For our purposes, however, the default value of 3 Volts is acceptable without change.

Pressing Softkey 1, 2 or 3 will advance the display to:

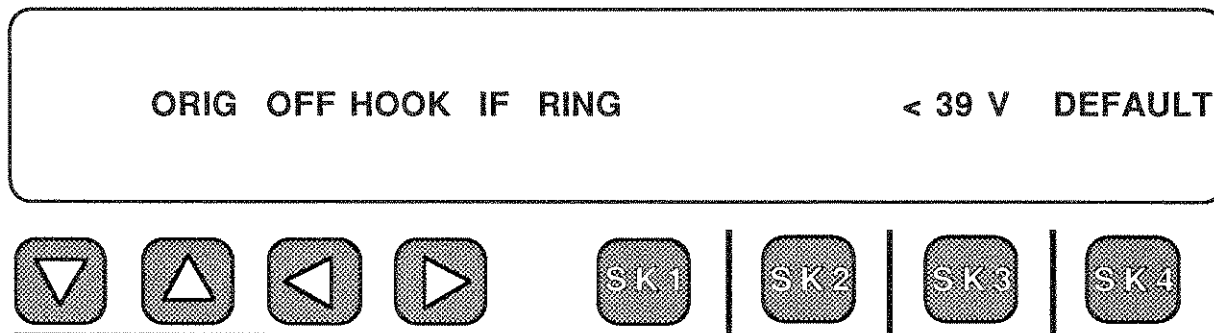

When the contact side goes **OFF HOOK**, it places ground on Ring or provides loop after the battery side has grounded Tip. In either case, the voltage on Ring goes toward ground. The preset default threshold is 39 Volts, as shown above. If the circuit is a -24 Volt system, the threshold should probably be set to about 20 Volts. Enter 2 and 0 and press **ENTER**. Press Softkey 1, 2, or 3 and the screen will advance to:

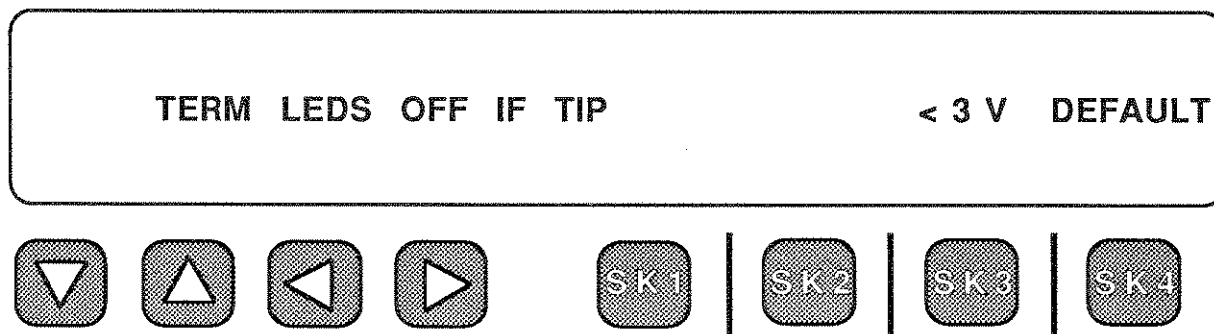

If there is no high impedance supervision battery on Tip, or a loop condition exists and there is no talk battery on Ring, there will be no voltage present on Tip and the 930A will turn off the supervision LEDs on the battery side. The factory set default is 3 Volts, as shown above. The value may be changed by entering the desired value from the numeric keypad and then pressing the **ENTER** key. For this example this value is acceptable as is.

Press Softkey 1, 2, or 3 and the 930A display will advance to:

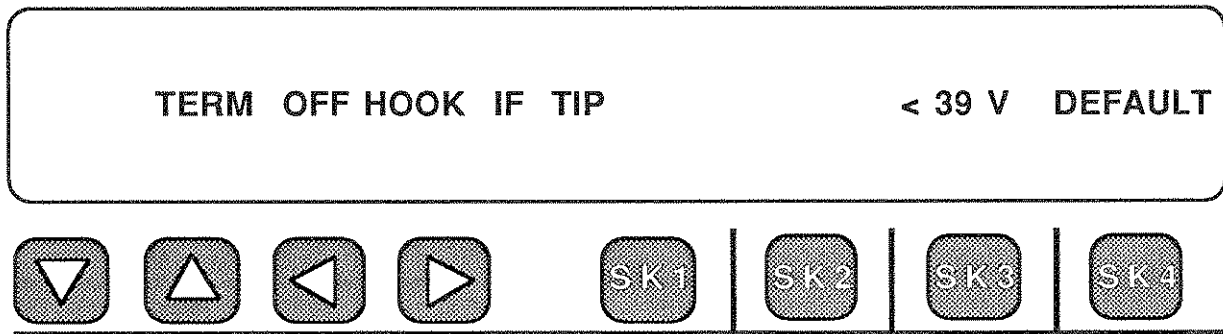

When the battery side goes **OFF HOOK**, or connects a digit receiver, it grounds Tip and the voltage on Tip goes toward ground. The default threshold is 39 Volts, as shown above. We want to change this value to 20 Volts in this example. Enter **2** and **0** from the numeric keypad and then press **ENTER**. Press the **OPTION MENU** key to exit from this menu.

The 930A is now set to receive 24 Volt supervision.

REMEMBER

You must return to these displays after you are finished testing and reset them to their default values to avoid problems on normal circuits. A "Cold-Boot" will also restore the defaults.

5-7.5 HOW TO CHANGE E&M SUPERVISION THRESHOLDS

The various E&M Types (1 through 5) have different means of providing supervision battery to the **E** and **M** leads but the end result is the same. In one supervision state the lead is held at -48 Volts. In the other state it is held close to ground. The intermediate voltages are interpreted as "no indication" and the 930A turns off the appropriate LEDs.

For this example the 930A is assumed to be set to 4-wire, E&M Type I, SEND-M operation with a 24 VDC supervision trunk instead of the normal 48 VDC.

Upon entering Menu Option 7, the 930A display will be:

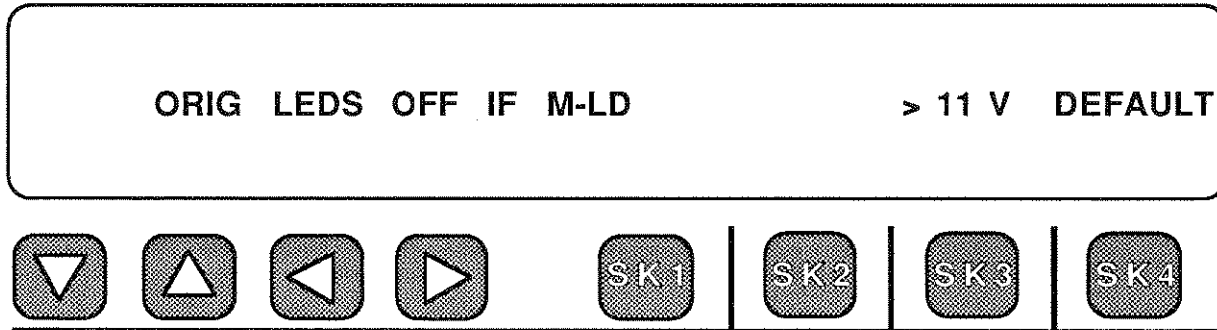

This display shows the default value which will turn off the originating supervision LEDs if the **M** Lead voltage is greater than 11 Volts but less than the **OFF HOOK** threshold.

Since 24 Volts is half of 48 Volts, a good guess is to reduce everything displayed by half. So instead of 11 Volts we enter 6, which is roughly half, using the keypad and the **ENTER** key as previously described.

Next press either Softkey 1, 2, or 3 and the display advances to:

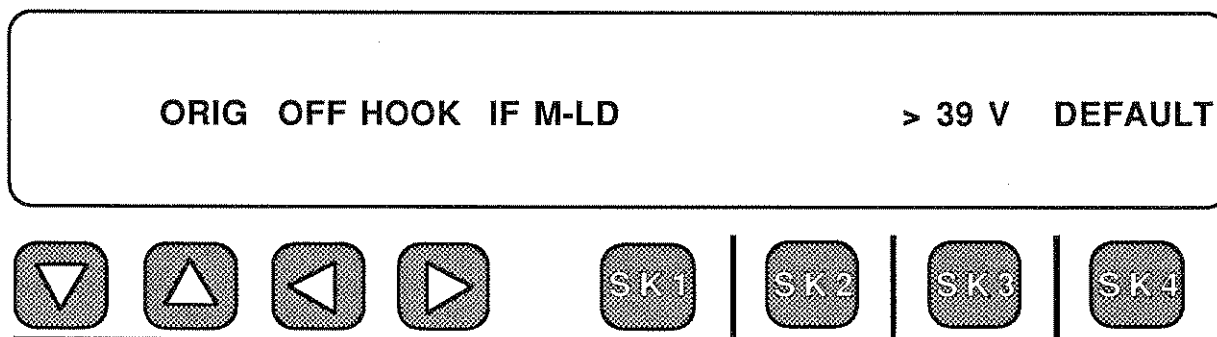

In this case the 930A will provide an **OFF HOOK** indication on the Originating LEDs if the voltage on the **M** Lead exceeds the 39 Volt threshold. This value has to be changed to 20 Volts (roughly half of 48). This is accomplished the same way by entering **2** and **0** and then pressing the **ENTER** key.

The 930A display now looks like:

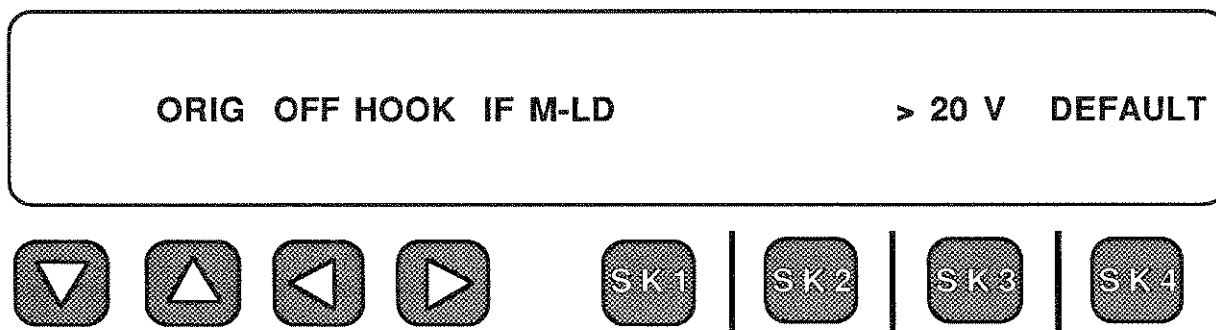

Pressing Softkey 1, 2, or 3 will advance the display to:

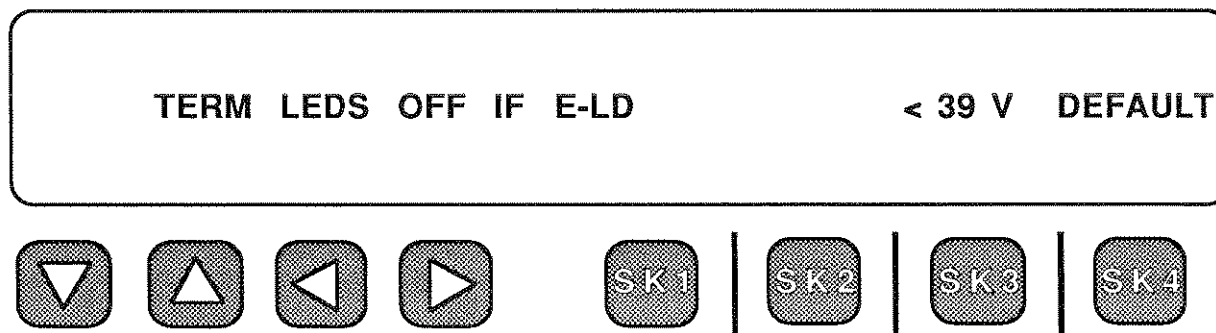

Here the 930A will provide no supervision indication if the voltage on the E Lead is below the high threshold of 39 Volts but above the low threshold of 11 Volts. The high threshold can be changed to 20 Volts as before and the 930A display will change to:

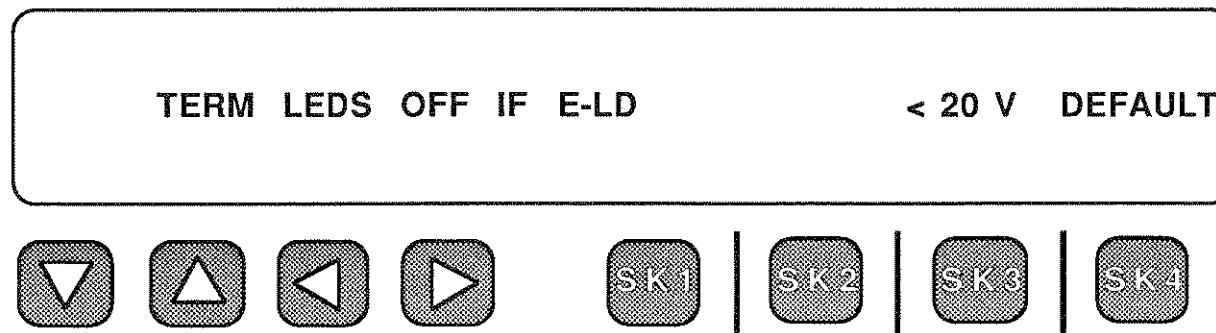

Pressing Softkey 1, 2, or 3 advances the display to the one shown on the following page.



An **Offhook** indication on the front panel LEDs will be provided if the voltage on the **E Lead** is below the 11 Volt low threshold. This value must be changed to 6 Volts in the same manner as the others which would make the display appear as:

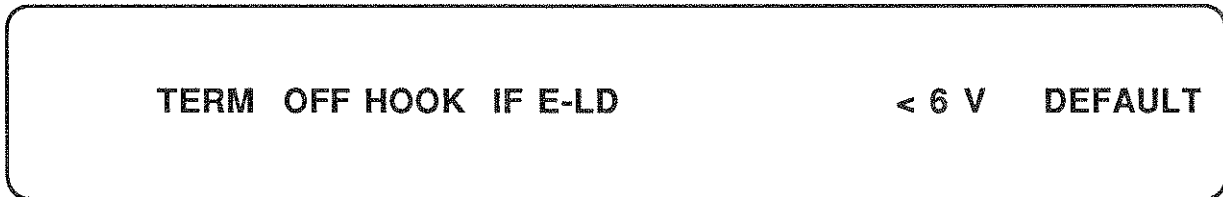

When the thresholds have all been set, press the **OPTION MENU** key to return to the Option Menu 7 display repeated below:

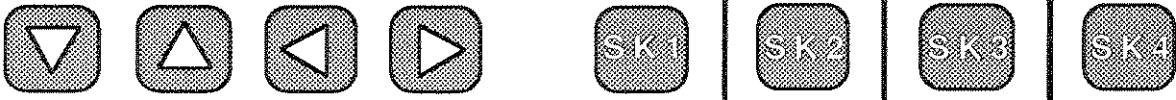
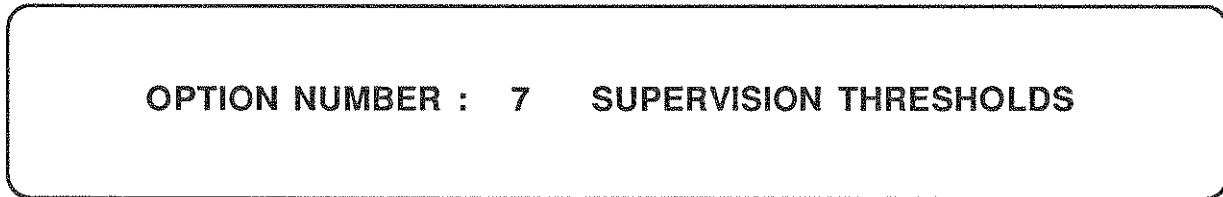

REMEMBER

You must return to these displays after you are finished testing and reset them to their default values to avoid problems on normal circuits. A "Cold-boot" will also restore the defaults.



5-8 MEASURING SUPERVISION EVENT TIMES (MENU OPTION 8)

Menu Option 8: **SUPERVISION MONITOR** gives the Model 930A the equivalent of a "strip chart recorder" function for timing events of long duration as well as for timing supervision events such as guard times, ground start timing and other events not covered by Menu Option 9: **WINK TIMING**.

This Menu Option will work on analog, as well as T1 PCM, trunks with the 930A terminating the circuit or monitoring it (**Bridged** on analog trunks and **MONITOR** mode on PCM). The following paragraphs will give you a general idea of how this menu functions. This is followed by specific examples of measurements on ground start trunks and the optional PCM trunks.

To use this Menu Option set it up in the following manner:

Press the OPTION MENU  Option Menu function key.

Use the UP/DOWN   arrow keys to select Menu Option 08: SUPERVISION MONITOR.

The display will appear as shown below:

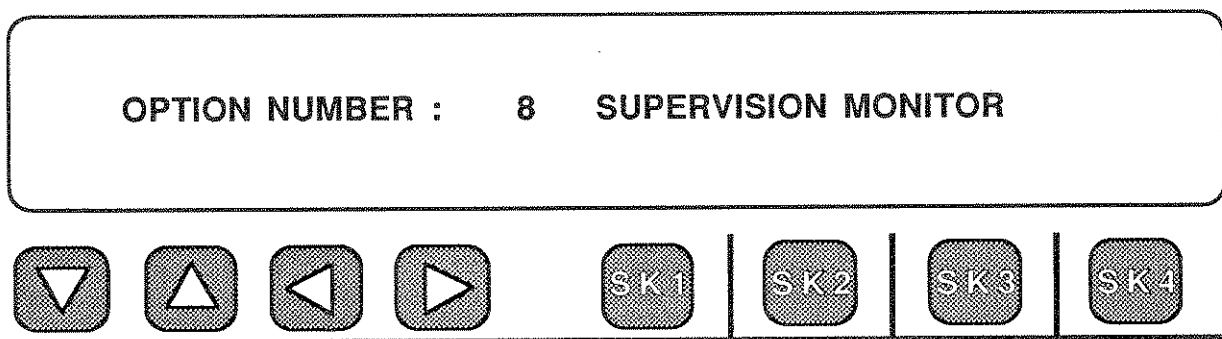

Press any softkey under the display to bring up the main menu:

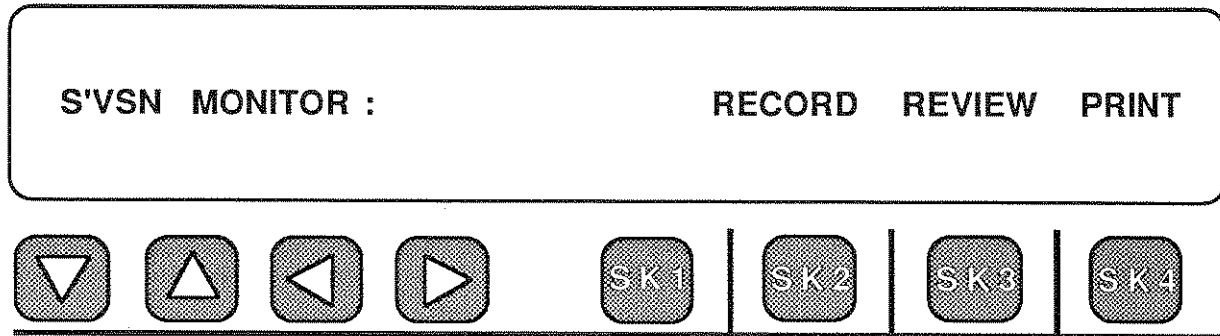

To record events in a time line format, press Softkey 2 (under **RECORD**) and the 930A will act very much like a strip chart recorder. It will record supervision events such as **On Hooks** and **Off Hooks**. Just as with a strip chart recorder however, it is up to you to determine what is going on over time. After pressing Softkey 2 the 930A display will appear as:

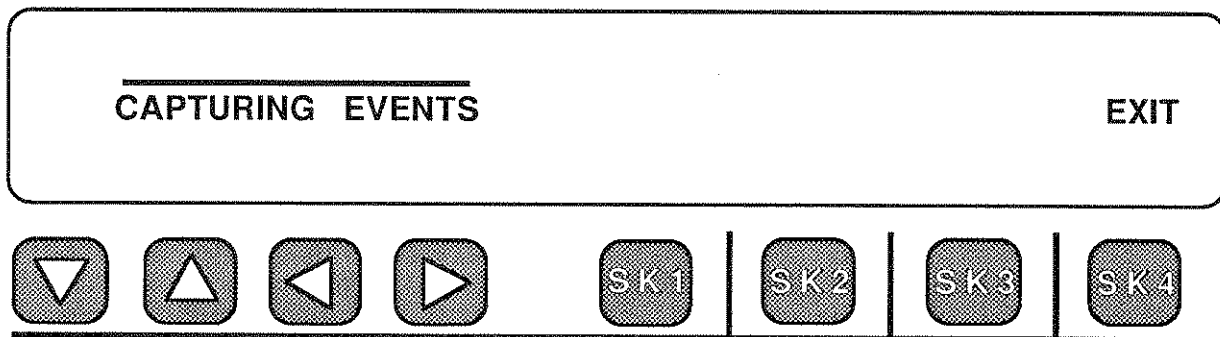

The cursor flashes over the words **CAPTURING EVENTS**. When you feel that enough data has been obtained, press Softkey 4 (under **EXIT**) to return the 930A to the main menu and stop the data acquisition. The main menu is repeated below:

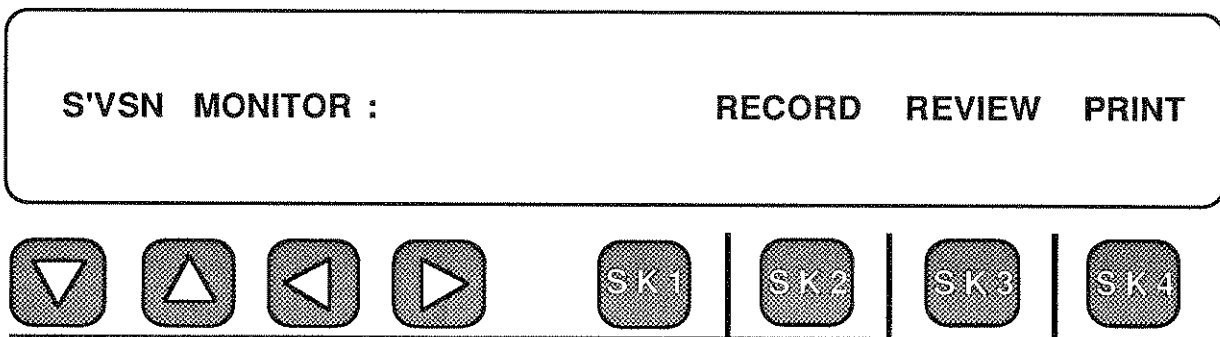

The events captured in the **RECORD** mode may now be reviewed by pressing Softkey 3 (under **REVIEW**). The display of the events varies according to the trunk type the 930A is set up to emulate. For example, if the 930A had been timing events on a metallic trunk such as a Loop Start or Ground Start trunk, the results would be displayed as shown in the example below:

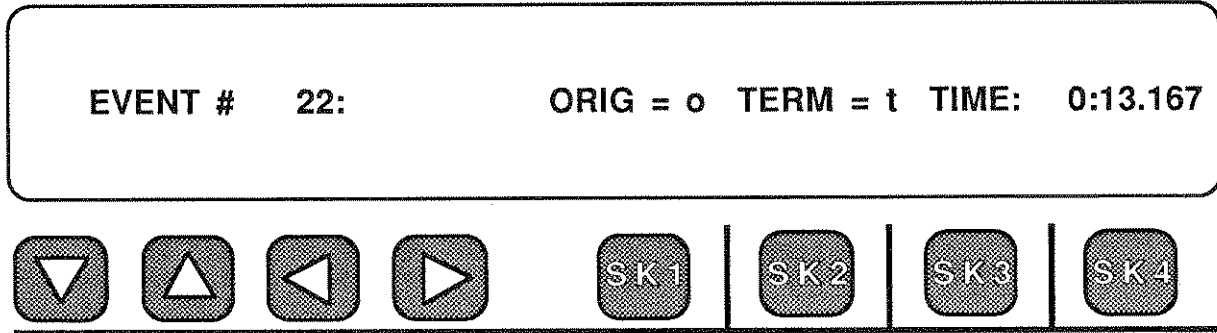

The display follows the front panel supervision LEDs. In this case both the Originate and Terminate sides of the circuit are **Onhook** as indicated by the lower case letters "o" and "t". The time is displayed as minutes:seconds.milliseconds up to 255:59.999. An example of a sequence of events will demonstrate how this works in practice. Suppose the 930A had been capturing events for a period of time. After stopping the data collection as described above, the first displayed result is:

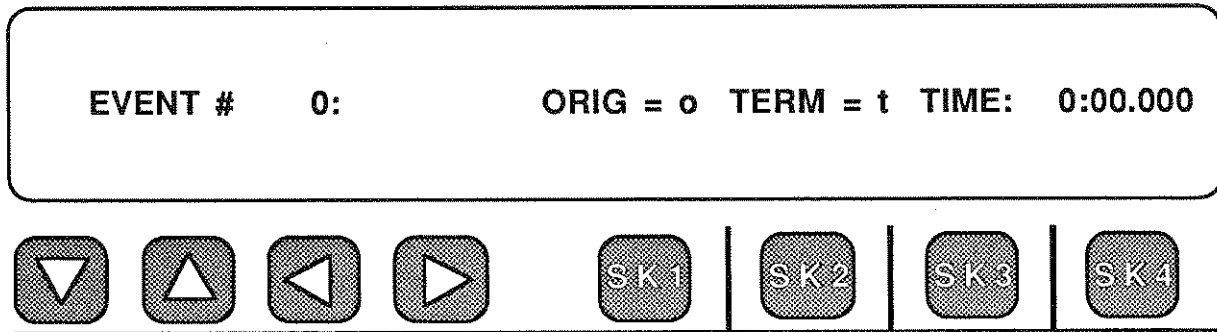

By pressing the **UP** Arrow key, or Softkey 1, you can scroll up through the rest of the results.

The next event, for example, might be:

| | | | | | |
|---------|----|----------|----------|-------|----------|
| EVENT # | 1: | ORIG = O | TERM = t | TIME: | 0:00.406 |
|---------|----|----------|----------|-------|----------|



Here the Originating end has gone **Offhook** (Uppercase O) after 406 milliseconds. The display of event #2 might be:

| | | | | | |
|---------|----|----------|----------|-------|----------|
| EVENT # | 2: | ORIG = O | TERM = T | TIME: | 0:01.636 |
|---------|----|----------|----------|-------|----------|



The Terminate end has gone **OffHook** after 1.636 seconds. The 930A can **time up to 200 events or for up to 4 hours** unless a printer is connected. In this case the 930A continuously dumps its buffer when full and records continuously. If the supervision on the line enters an undefined state (neither **OnHook** nor **OffHook**), the 930A will display it as undefined by showing a dash "-" instead of an upper or lower case character. Only supervision events are shown. Tones, digits and speech are not captured by the supervision monitor. **An undefined state** is shown below:

| | | | | | |
|---------|----|----------|----------|-------|----------|
| EVENT # | 5: | ORIG = - | TERM = T | TIME: | 1:24.175 |
|---------|----|----------|----------|-------|----------|



5-8.1 MONITORING GROUND START SUPERVISION

Now that you have a rough idea of how Menu Option 8 functions, this example will explain how Ground Start supervision works and the kinds of events you might want to time using the 930A.

You setup the 930A to a Ground Start trunk type and then go to Menu Option 8, enter the menu, select **RECORD**, capture the events and then exit back to the main menu; just as it was detailed in the previous section. The hard part is figuring out what all this means.

Some of the supervision events you might want to time on a Ground Start trunk would include: The time it takes for the Central Office switch to recognize trunk seizure, the length of the Open Switch Interval (OSI), how long it takes your PBX to recognize Tip Ground, and how long the Central Office has to wait for loop from your PBX.

5-8.2 HOW TO MEASURE A/B/C/D BIT TIMING

Many times you want to measure the timing of the outgoing and incoming A and B bits (or C and D bits on ESF). Up to now, you had to haul out a strip chart recorder or something like that. The 930A gives you the capability to measure these bits down to 1 millisecond accuracy. This feature is most useful when you can look in both directions.

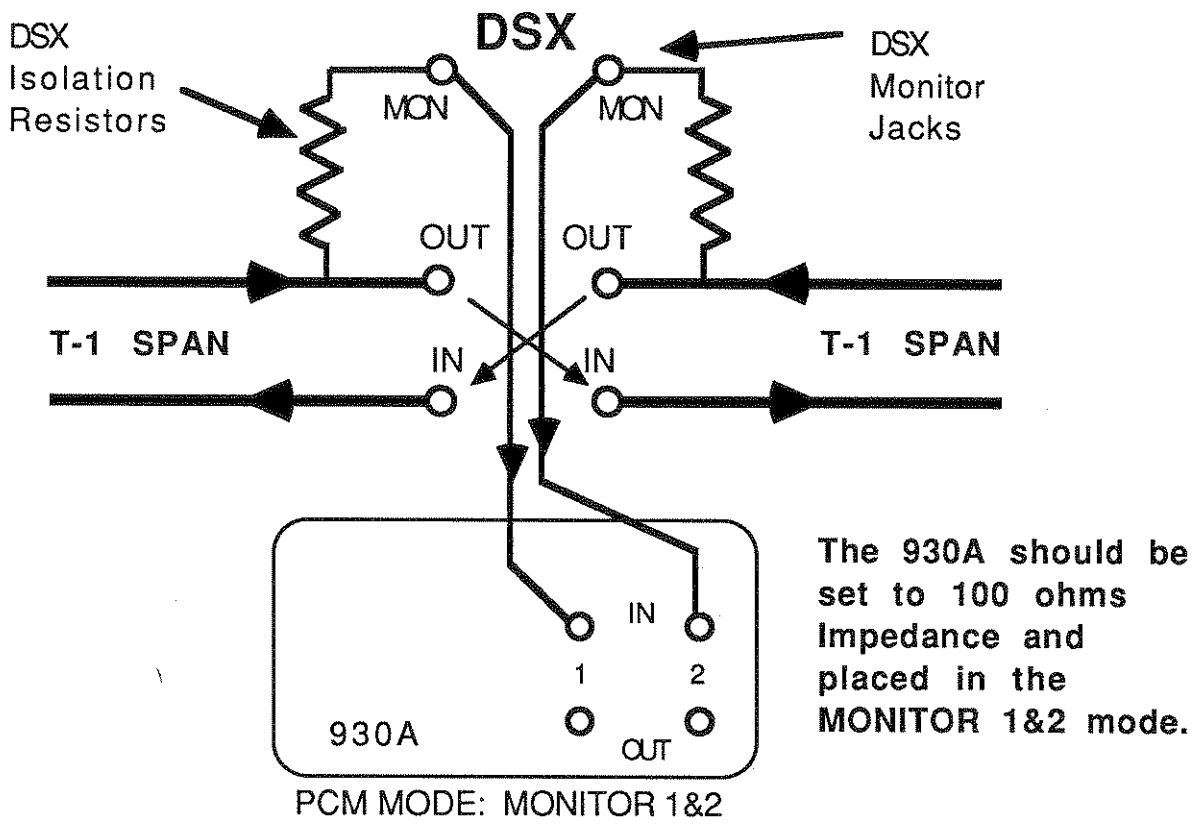

T-1 SUPERVISION EVENT TIMING WITH THE 930A
FIGURE 5-1

Set your 930A to the **MON-1&2** mode of the **PCM Trunk Type** as previously described in Section 4-3. Next, do the following.

Press the **OPTION MENU**  **Option Menu** function key.

Use the **UP/DOWN**   arrow keys to

get to **Menu Option 8: SUPERVISION MONITOR**.

OPTION NUMBER : 8 SUPERVISION MONITOR



Press any softkey under the display to get to the main menu.

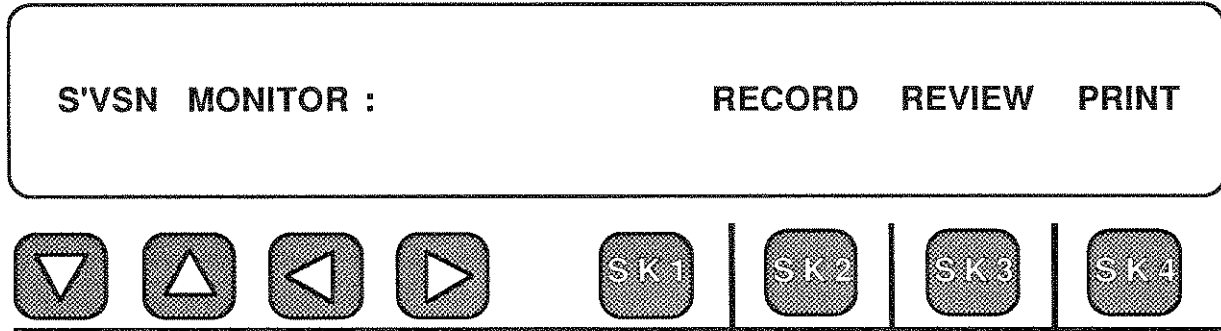

Whenever you want to start recording the supervision bits and their changes of state, press Softkey 2 (under **RECORD**) and the 930A will start recording and show you the screen below.

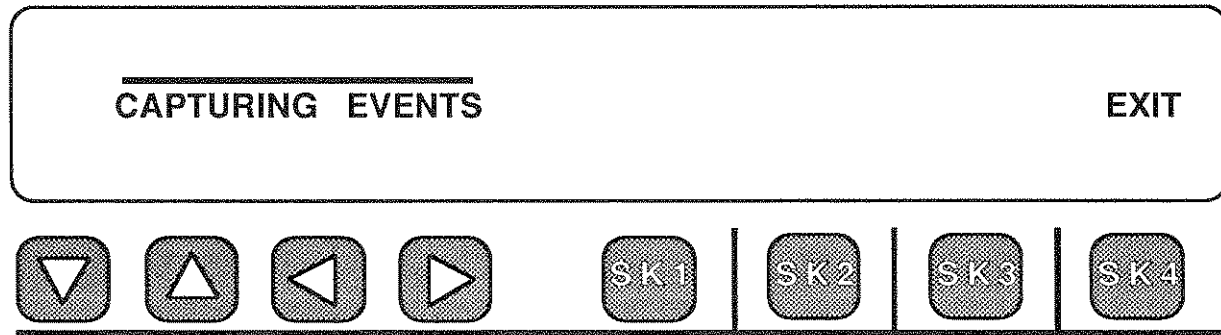

When you have recorded enough events (you can see the front panel supervision LEDs changing from On to Off Hook), press Softkey 4 (under **EXIT**) and you get back to the main menu.

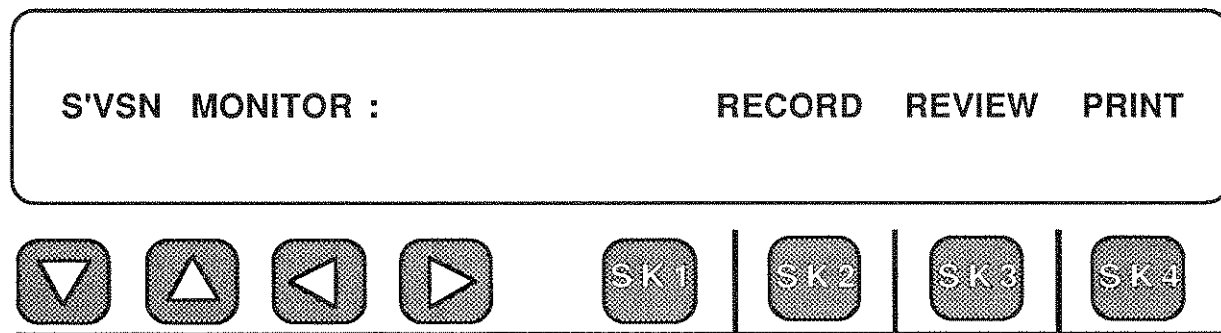

You can dump the buffer to a printer, if you have that option, or you can review the results one at a time. You can tell, for example, which end of a circuit is dropping calls, when, and which bit is at fault.

To review the results, press Softkey 3 (under REVIEW) and the first event will be shown.

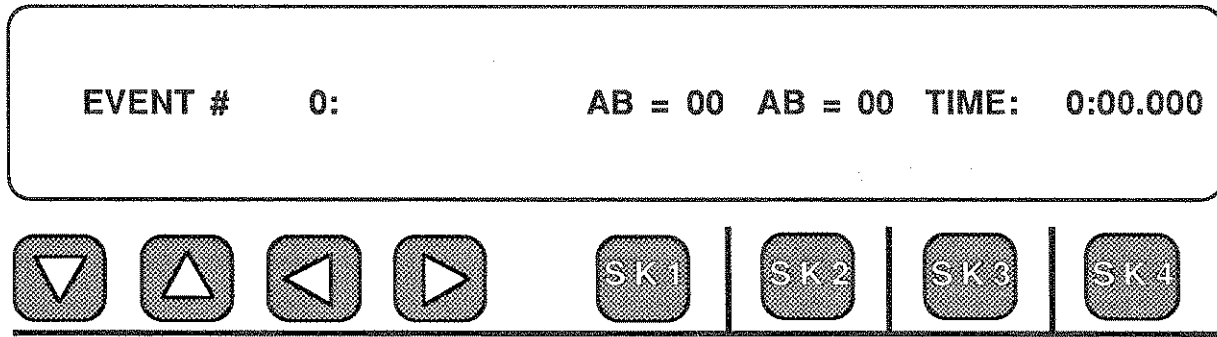

This is usually an ON HOOK state as shown above. Then you press the UP Arrow key to go up through the results. Example displays are shown below:

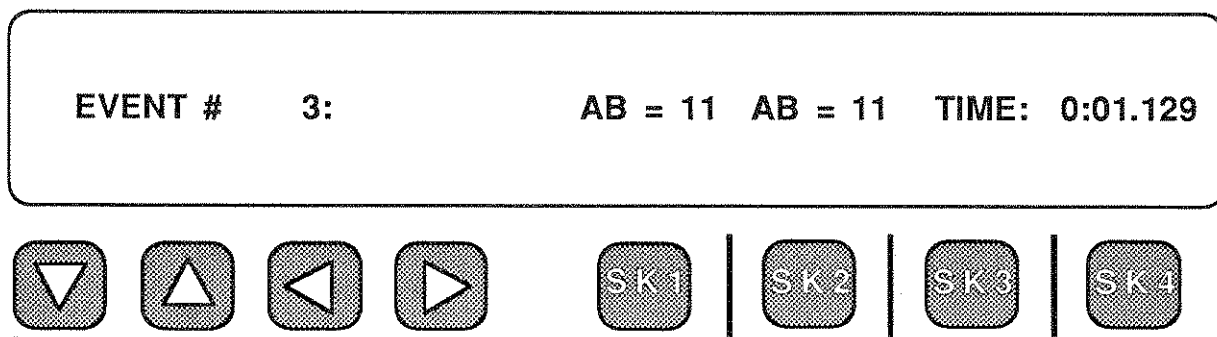
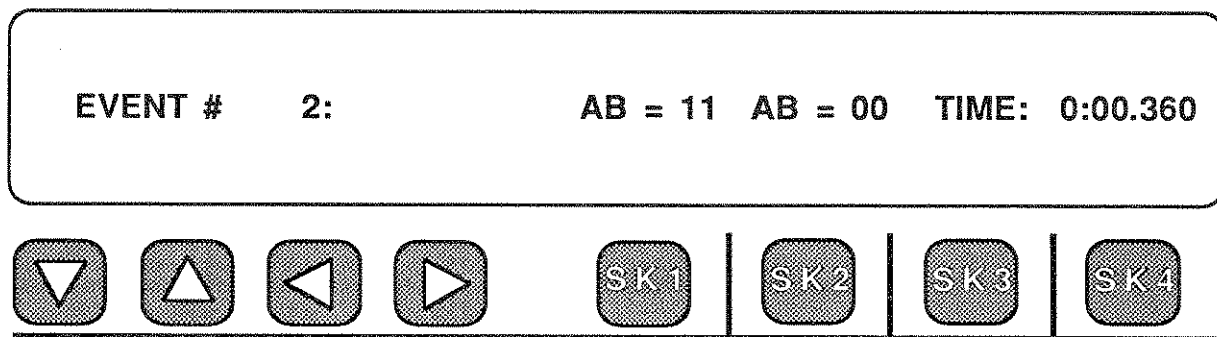
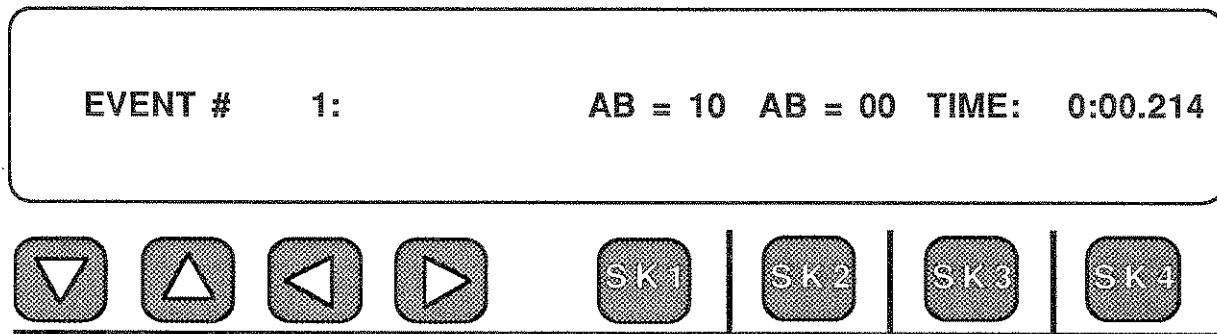



5-9 HOW TO MEASURE WINK TIMING (MENU OPTION 9)

Menu Option 9: **WINK TIMING** is used with, and is automatically set up by, Menu Option 2: **SEND DIGIT SEQUENCES** or Menu Option 4: **DIGIT RECEIVER** (if Option 930A-01 has been purchased). Menu Option 9 enables timing of Wink, Pre-Wink (Guard Time), and Off Hook Supervision events.

To use Menu Option 9, you **must first** setup a digit sequence in Menu Option 2 or set up the sequence to be received in Menu Option 4.

After you have outpulsed the call, **then** you can measure the **Wink Timing** by going to Menu Option 9 as follows:

Press the OPTION MENU  Option Menu function key.

Use the UP/DOWN   arrow keys to select Menu Option 9: **WINK TIMING**.

The 930A display will show:

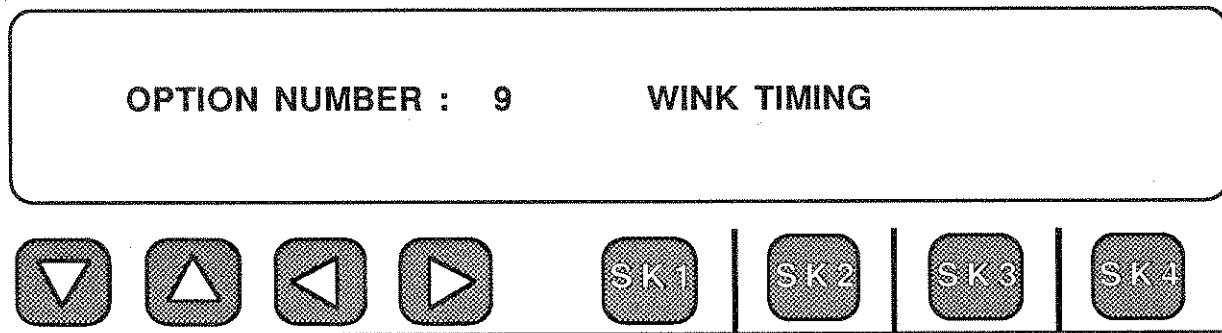

Enter the Menu Option by pressing any softkey. The display will show you the sequence as it was keyed in under **SEND DIGIT SEQUENCES**. The display can appear as shown below:

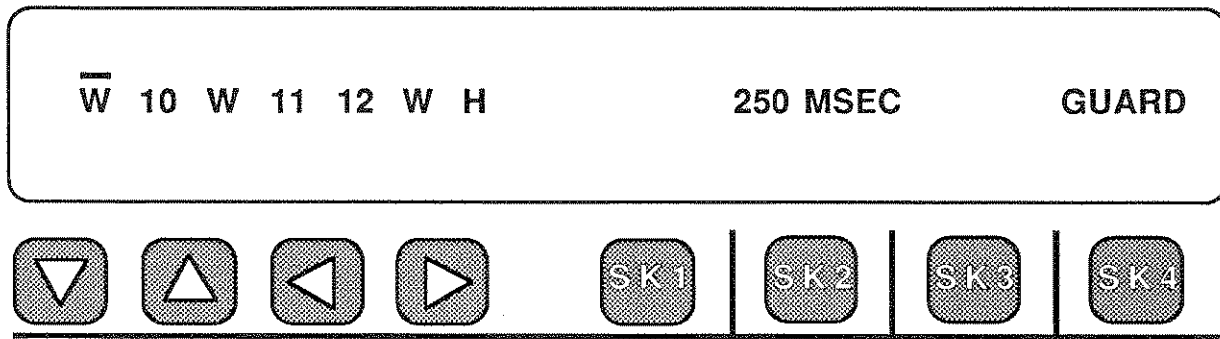

A flashing cursor will appear over the last completed wink or Off-Hook in the sequence. If a wink or Off-Hook has failed, the cursor will appear over the failed event. If the sequence has not yet been outpulsed, the cursor will appear over the first supervision event and all measurements will be zero. There will be a measurement, "NNNN MSEC", where NNNN is the length of time in milliseconds spent waiting for the event (the Guard Time). The word "GUARD" is displayed to label the measurement. This is the time from initial seizure to the beginning of the Wink.

The left and right arrow keys allow you to move the cursor within the sequence to examine any supervision event. For example, you may want to measure the duration of the second wink in the sequence above. Using the Right arrow key, move the cursor over the second wink, then press Softkey 4 and a display will appear similar to the one below:

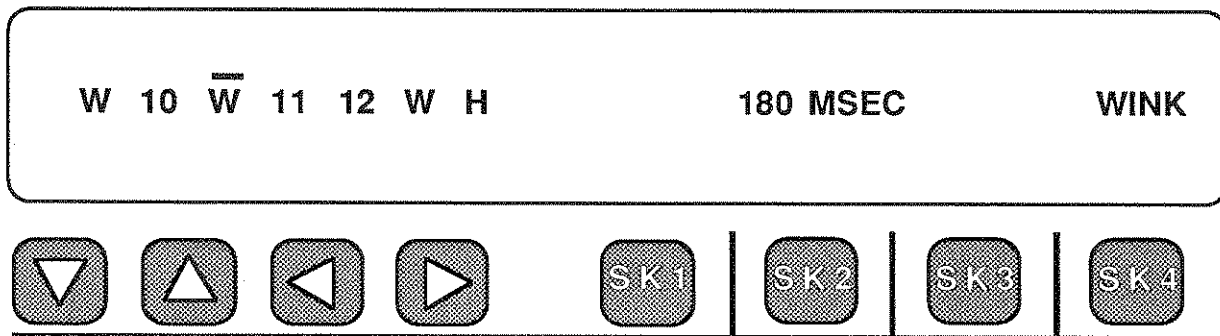

The measurement always refers to the event under the cursor. Softkeys 1, 2, and 3 are inactive while Softkey 4 toggles between GUARD and WINK timing measurement (if the event is a Wink), or GUARD and OFF HOOK time measurement (if the event is an Off-Hook).

All measurements are in milliseconds. If the Guard time exceeds 16 seconds, the event "fails". In such a case the **GUARD** display would read ">16000 MSEC", and the wink or off-hook measurement would read "FAILED".

If the event is a wink, it fails if the period exceeds 600 msec. If the event is an off-hook, it fails if this period is less than 200 msec. You can also use Wink Timing to measure Delay Dial events. A Delay Dial event fails if the Guard period exceeds 16 seconds, or if the off-hook period exceeds 16 seconds.

5-10 USING THE FREQUENCY SWEEP (MENU OPTION 10)

Menu Option 10, **FREQUENCY SWEEP**, is a standard feature on all Model 930A's. This Menu Option lets you set the 930A to sweep up or sweep down in frequency, either one time or continuously. The frequency limits, step size, amplitude, and sweep times are user-selectable for maximum flexibility. In addition, you can set the 930A to either skip, or not skip, the SF frequency during the sweep.

To set up the 930A frequency sweep function, perform the following steps:

Press the OPTION MENU  **Option Menu** function key.

Use the UP/DOWN   arrow keys to

select Menu Option 10: **FREQUENCY SWEEP**.

The 930A display will appear as shown below:

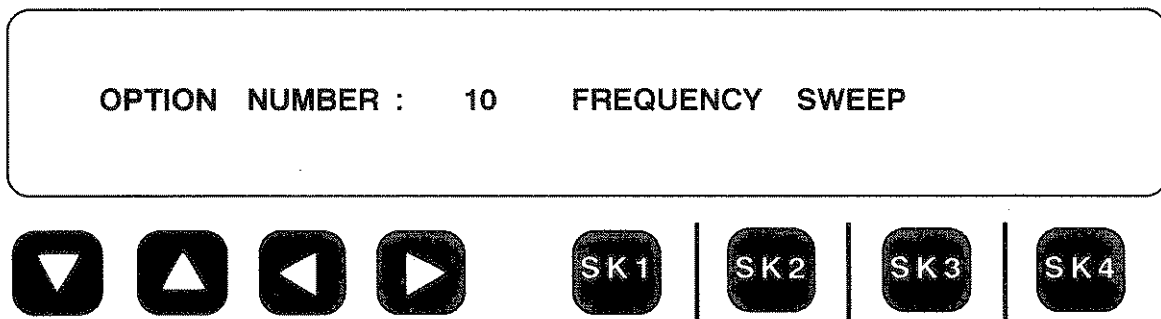

Pressing any softkey will get you into the Menu Option. Once inside Menu Option 10 the 930A display will be as shown below:

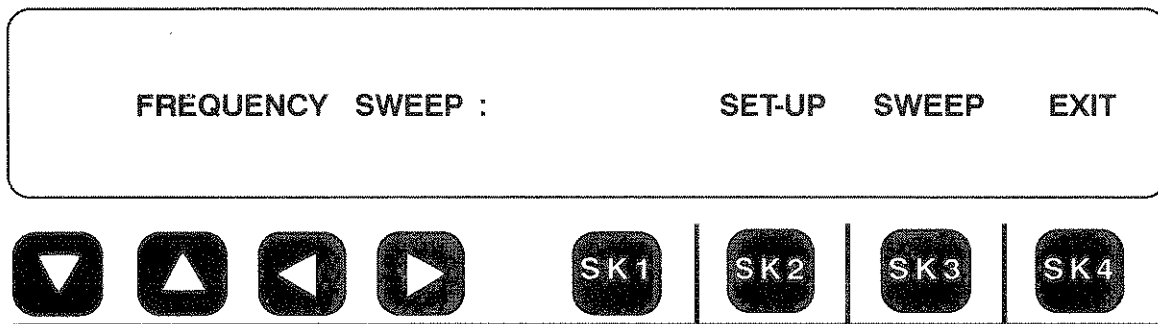

The 930A retains any set-ups previously input. It is not normally necessary to go through the set-up process each time the sweep function is used, unless you want to change the parameters.

The 930A's standard default sweep setting is the most commonly used sweep for attenuation distortion measurements. Most of the time you can go directly to **SWEEP**. **The default parameters are:** Sweep from 304 Hz to 3204 Hz in 100 Hz steps, skip the SF frequency band, wait 3.5 seconds between frequencies and send at a level of -16 dBm. An example of how to change these values follows.

Press Softkey 2 (under **SET-UP**) and the 930A display will appear as:

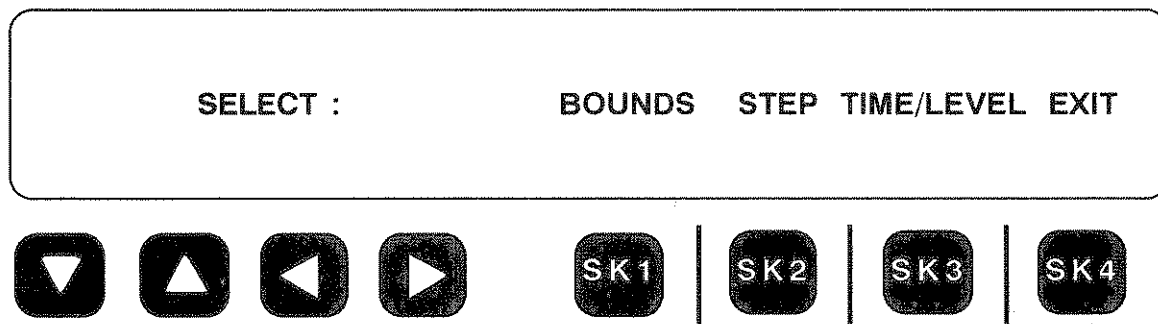

The following procedure outlines the steps to set-up the 930A sweep function for a frequency sweep of 204 Hz to 3804 Hz in 200 Hz steps with 5 seconds between frequencies and SF skip instead of the default. Press Softkey 1 (under **BOUNDS**) and the 930A display will show the last starting frequency used.

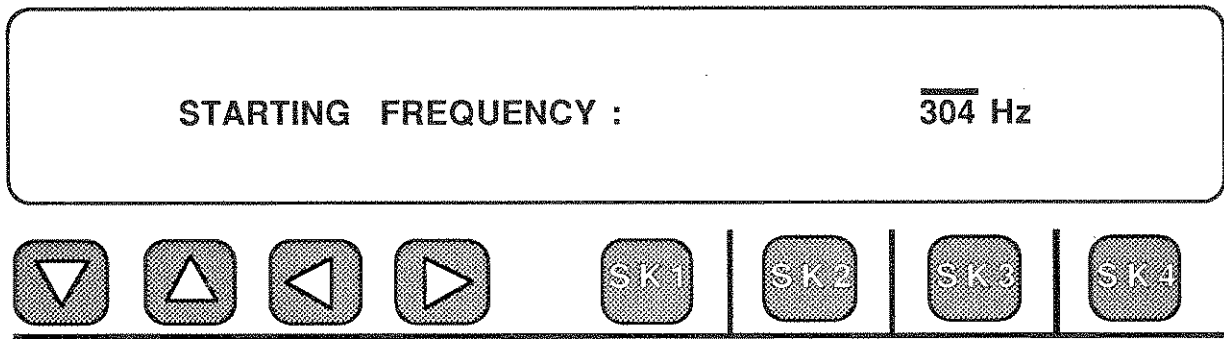

Here 304 Hz was the previous starting frequency. We want the 930A to sweep up from 204 Hz to 3804 Hz. To do this, enter the sequence "0", "2", "0", "4" on the keypad and press the **ENTER** key, or Softkey 3, to enter the 204 Hz value. The 930A enters the value and then asks you to enter the ending frequency you want,

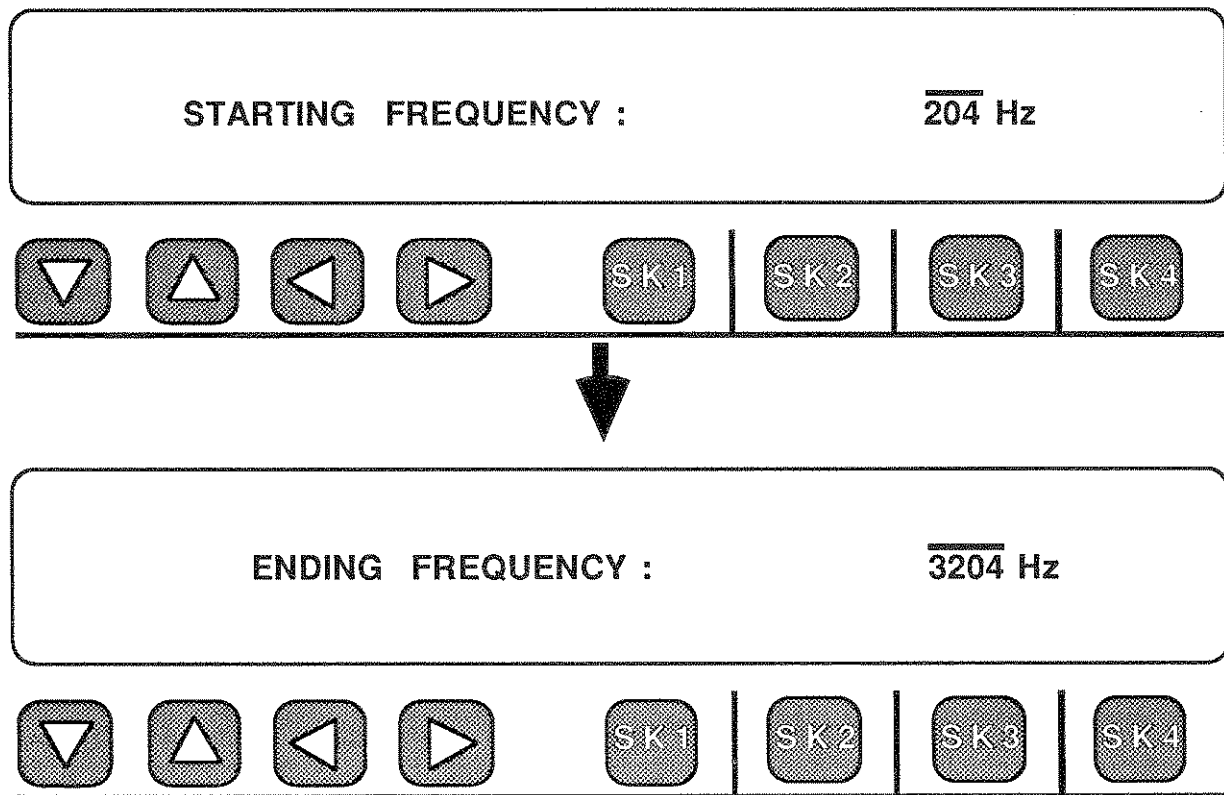

We want the ending frequency to be 3804 Hz so we enter the sequence "3", "8", "0", "4" on the keypad and press the **ENTER** key, or Softkey 3, to enter the 3804 Hz value. The display momentarily shows the new value as:

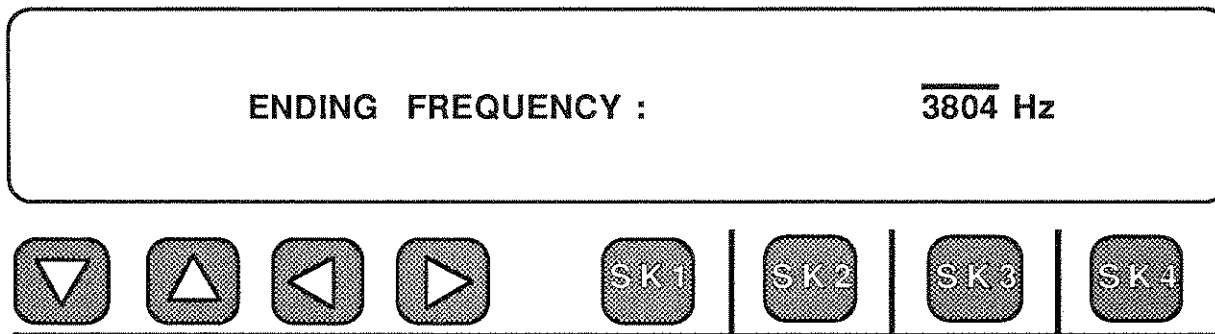

After entering the new ending frequency, the display changes to:

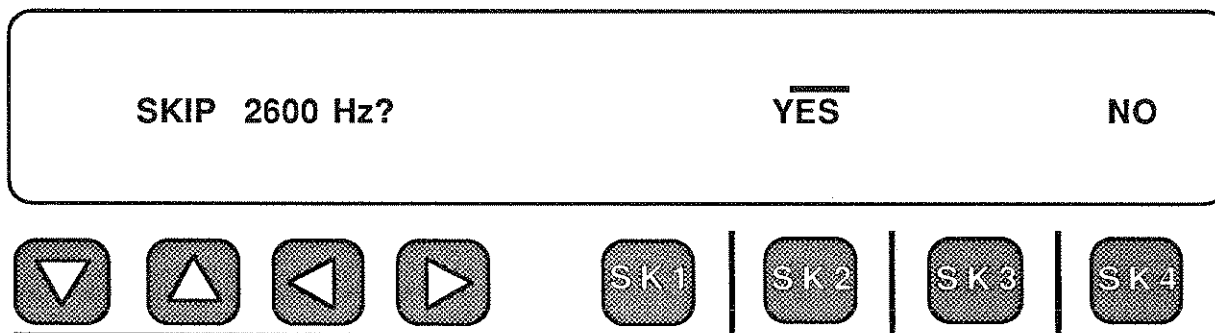

The 930A is now asking whether you want to skip the SF frequency (actually skips 2450 Hz to 2750 Hz) or not. Since we wanted to skip SF for this example anyway (usually you do skip SF), press Softkey 2 (under **YES**) and revert to the selection menu display shown below:

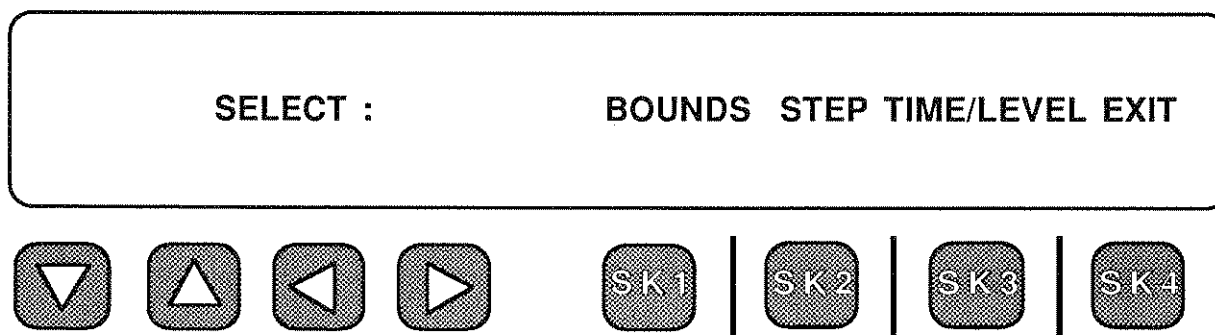

Now that the frequency bounds have been set, the next item is setting the frequency step size of the sweep. The 930A allows step sizes from 1 Hz to 999 Hz but the most common step size is 100 Hz. To change from this default value to the 200 Hz steps called for in this example press Softkey 2 (under **STEP**) and the 930A display becomes:

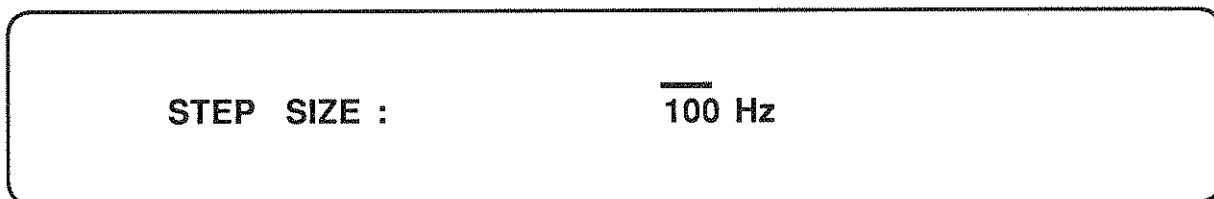

Enter the sequence "2", "0", "0" and press the **ENTER** key or Softkey 1. The 930A will momentarily show the new step size and then return to the selection menu below:

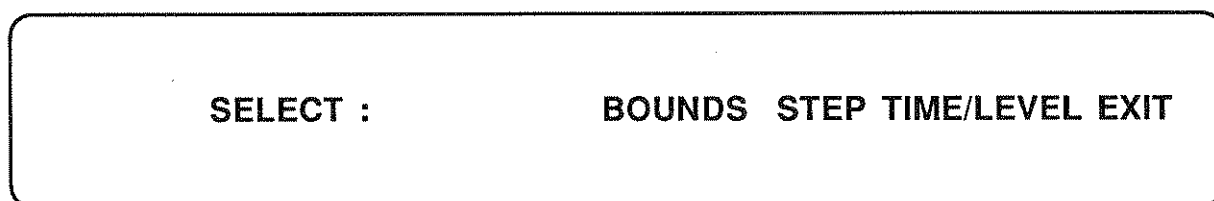

The next step is to select the sweep time between steps and the level at which the tones are to be sent. Press Softkey 3 (under **TIME/LEVEL**) and the 930A display becomes:

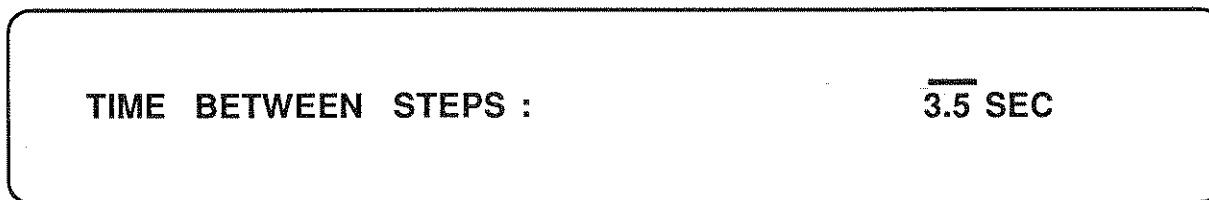

The 930A lets you select sweep times from 0.1 seconds to 9.9 seconds. The default is 3.5 seconds. A reasonable value which allows for instrument settling time as well as operator convenience is about 5 seconds. To enter a value of 5 seconds, use the numeric keypad to enter the sequence "5" and "0" and press the **ENTER** key, or Softkey 3. The 930A will immediately enter the value and change to the level select display below:

TIME BETWEEN STEPS : 5.0 SEC



LEVEL : - 16.0 dBm



To change the level to -10.0 dBm from the -16.0 dBm default, enter the sequence "1", "0", and "0" and press the **ENTER** key, or Softkey 1. The 930A will momentarily show the new level and then reverts to the main menu:

LEVEL : - 10.0 dBm



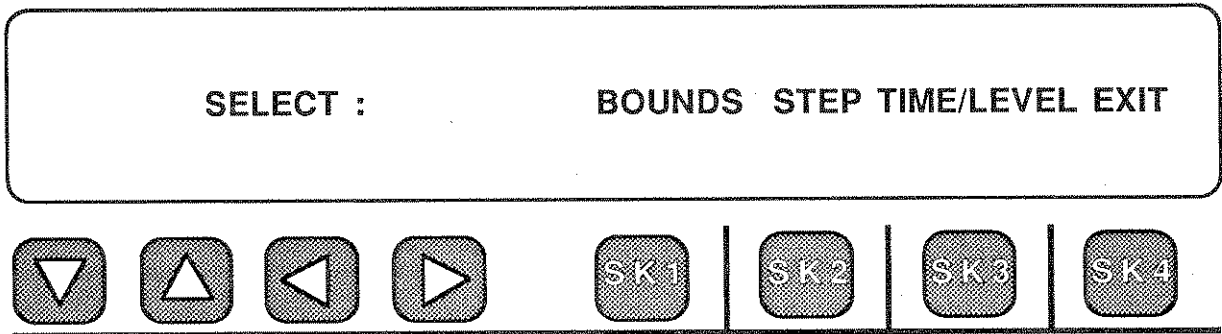

After you have entered the new sweep parameters, press Softkey 4 (under EXIT) to return to the main sweep menu shown below.

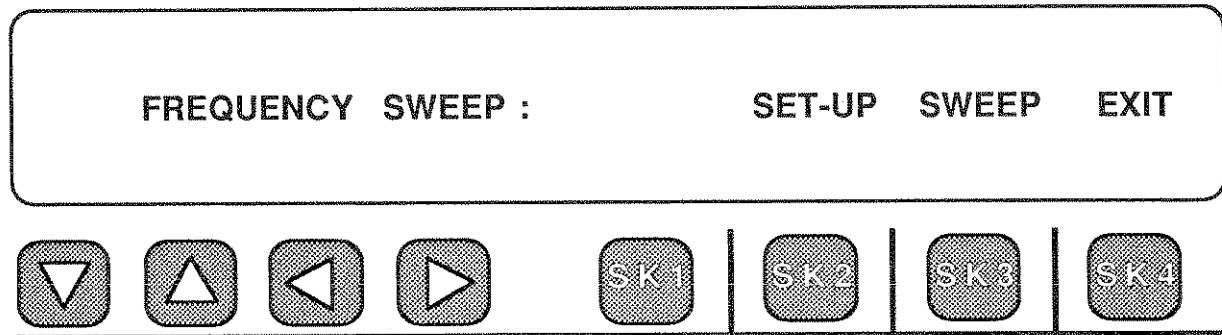

Pressing Softkey 3 (under SWEEP) causes the 930A to display:

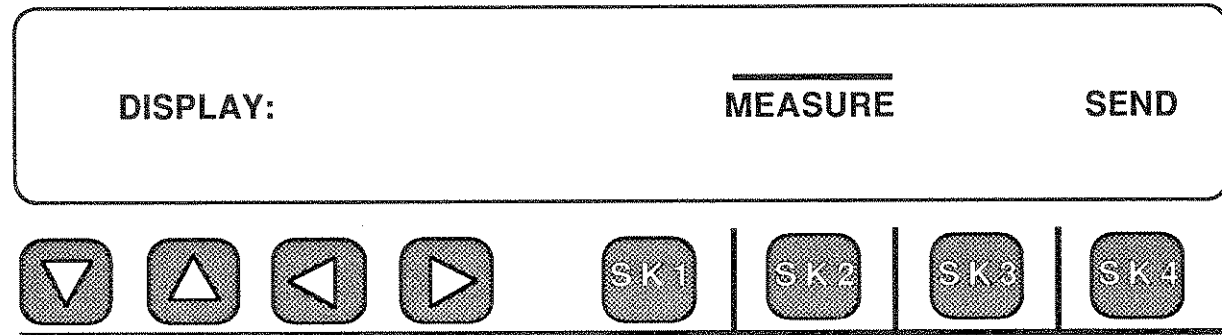

The flashing cursor appears over the previous selection. The two choices are **MEASURE** and **SEND**. The **MEASURE**, or 4-wire mode, enables the 930A to send and receive the sweep frequencies simultaneously. The **SEND**, or 2-wire mode, sends the sweep frequencies out from the 930A but does not receive. This mode would be used only for end-to-end measurements on 2-wire trunks where another test set is receiving the sweep at the far-end.

To select the **MEASURE** mode, press Softkey 2 and the 930A display will immediately change to the following:

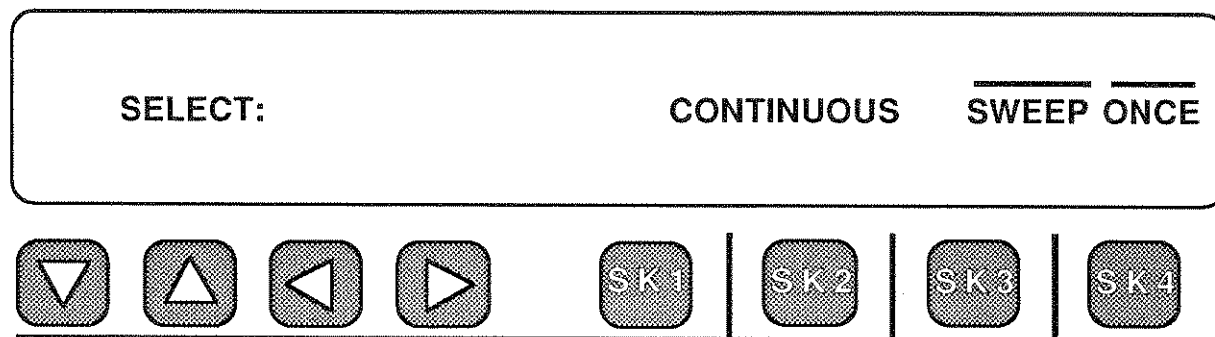

This asks you to choose between a one time sweep or a repetition of the sweep. Pressing Softkey 2 chooses continuous sweep and Softkey 4 chooses single sweep. If either key is pressed, the 930A immediately begins to send tone from the start frequency provided that the front panel Hook Switch has been placed in the OFF HOOK position. If the far-end has been looped back or another set is sending, then the 930A display will show the received frequency and level. An example of such a display is shown below:

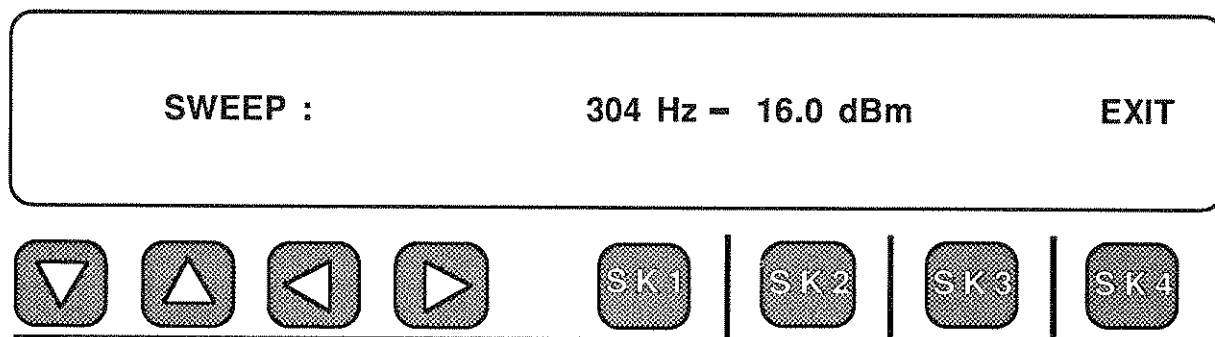

In the **MEASURE** mode, this is the received level and frequency. The 930A might be sending at -10.0 dBm and receiving at -16.0 dBm which would indicate a two-way loss of 6 dB at 304 Hz in this case. On a 2-wire trunk you must choose the **SEND** mode of operation because you cannot send and receive at the same time on a 2-wire trunk. The 930A display shows the outgoing tone level and frequency in this case.

To choose the **SEND** mode of operation, press Softkey 4 (under **SEND**):

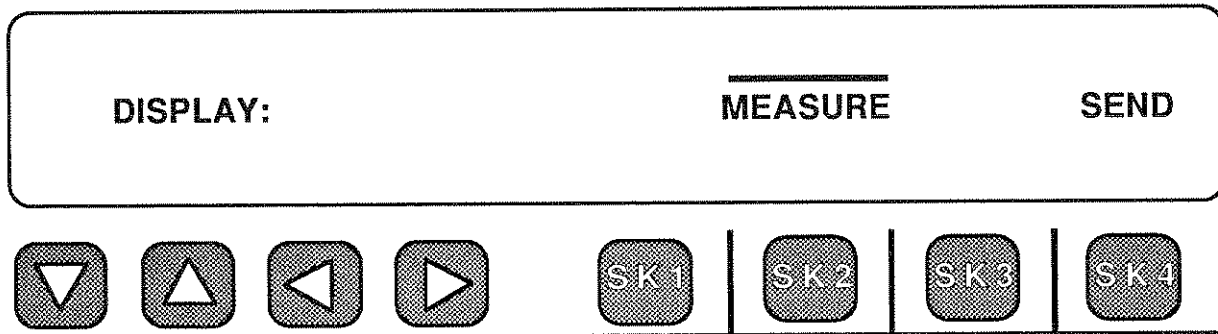

After pressing Softkey 4, the 930A display becomes:

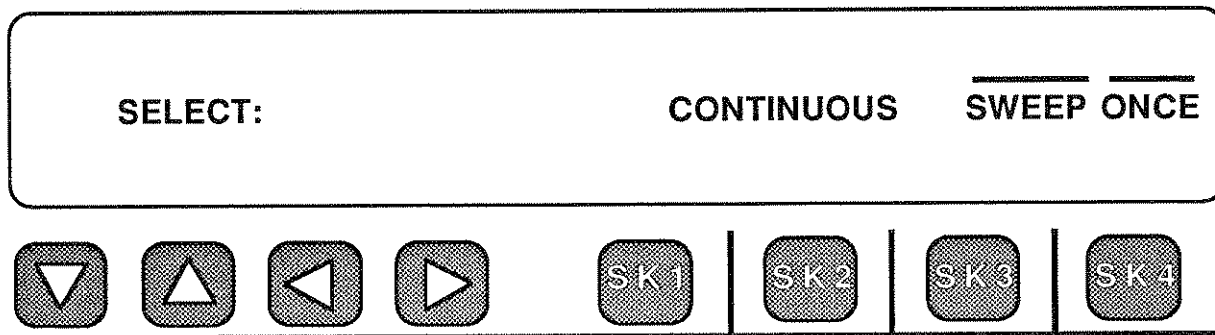

Press Softkey 2 (under **CONTINUOUS**) to continuously sweep through the band of frequencies selected, or press Softkey 4 (under **SWEEP ONCE**) to sweep once and stop. A typical 930A display might appear as:

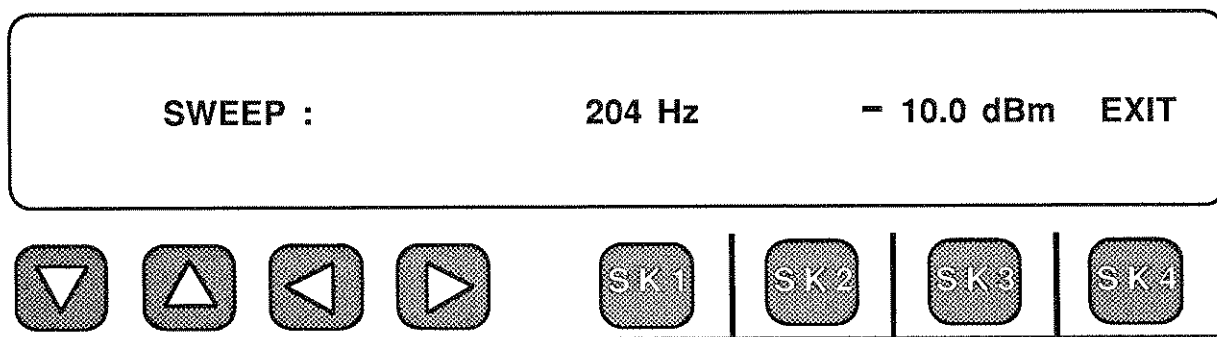

The 930A would step the frequencies by 200 Hz, starting at 204 Hz and proceeding to 404 Hz, 604 Hz, and so on.

Since SF skip was also chosen, the 930A would hold at 2404 Hz and pick up the sweep again at 2804 Hz. The 930A display alerts you to the fact that SF is being skipped by showing the word **SKIP**:

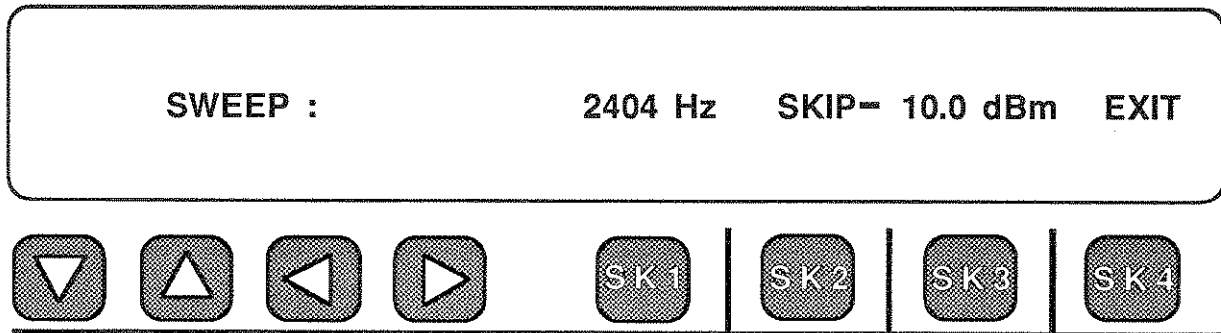

Some final points about the Frequency Sweep Menu Option follow. You can sweep down in frequency (in this example the sweep was up in frequency) by simply making the starting frequency the higher frequency and letting the ending frequency be lower. The 930A will then figure out that you want to sweep down, instead of up. The rest of the procedure is the same as that described in the example above. If a single sweep is chosen, the 930A will revert to the main sweep menu when the sweep has been completed.* You can stop the sweep at any time by pressing Softkey 4 (under **EXIT**), or the **OPTION MENU** key itself.



* If a continuous sweep is selected, the sweep will repeat until the operator manually stops it by pressing the **OPTION MENU** function key.

5-11 MEASURING 3-LEVEL IMPULSE NOISE (MENU OPTION 11)

The 3-Level Impulse Noise measurement option is set up and operated from Menu Option 11. The following step-by-step instructions demonstrate the set-up and measurement procedure.

To begin:

Press the OPTION MENU  Option Menu function key.

Use the UP/DOWN   arrow keys to
to select Menu Option 11, IMPULSE NOISE & HITS.

The Model 930A display will appear as:

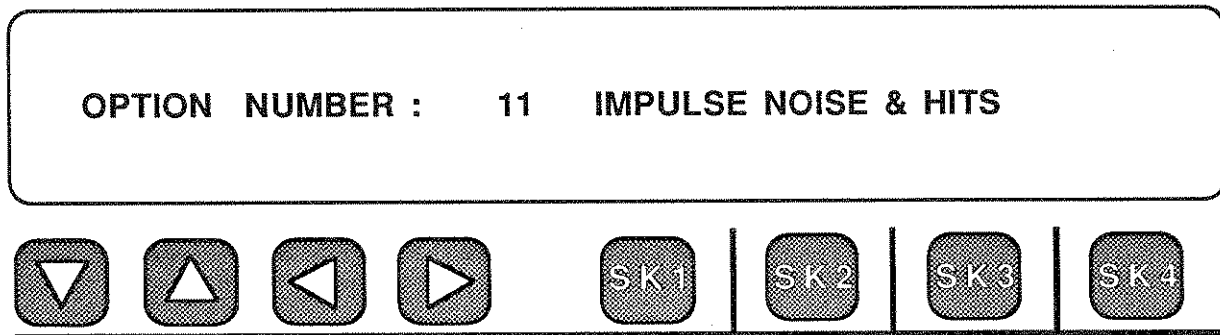

Pressing any softkey will enter the Menu Option. The main selection display appears as follows:

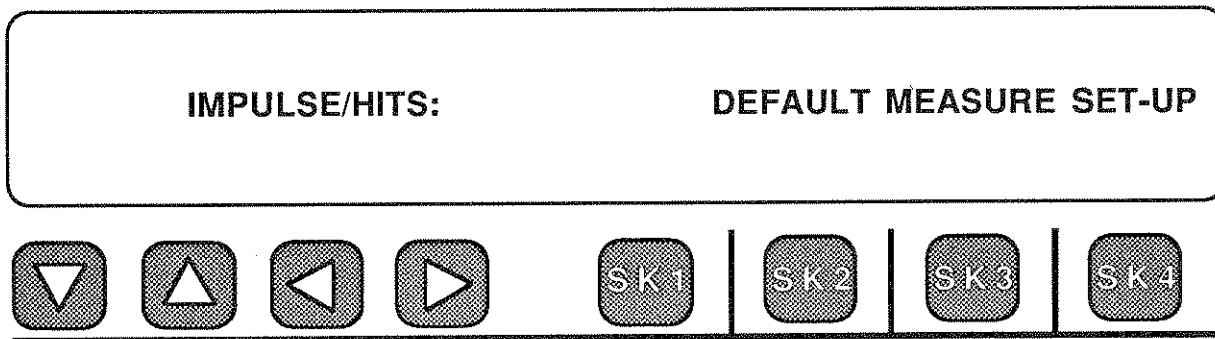

In this section, only the 3-Level Impulse Noise measurement will be described.

The above display offers three choices: Choosing the **DEFAULT** test parameters, begin **Measuring**, or manually **setting-up** the test parameters.

Pressing Softkey 2 (under **DEFAULT**) will set the correct default test parameters for Impulse Noise and Hits measurements on the **TRUNK TYPE** selected. The default values for Impulse Noise measurement are taken from AT&T published specifications for short haul (less than 500 mile length) Voiceband Data circuits. The default values include the fact that Impulse Noise is usually measured with the holding tone present. The tone is notched out using a C-Notch filter.

Pressing Softkey 2 (under **DEFAULT**) results in the display below:

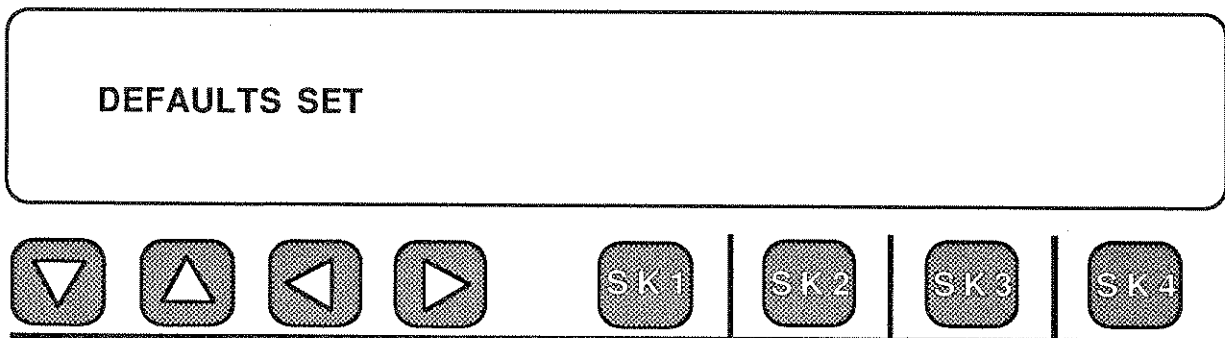

The display will then be returned to the original screen as shown below:

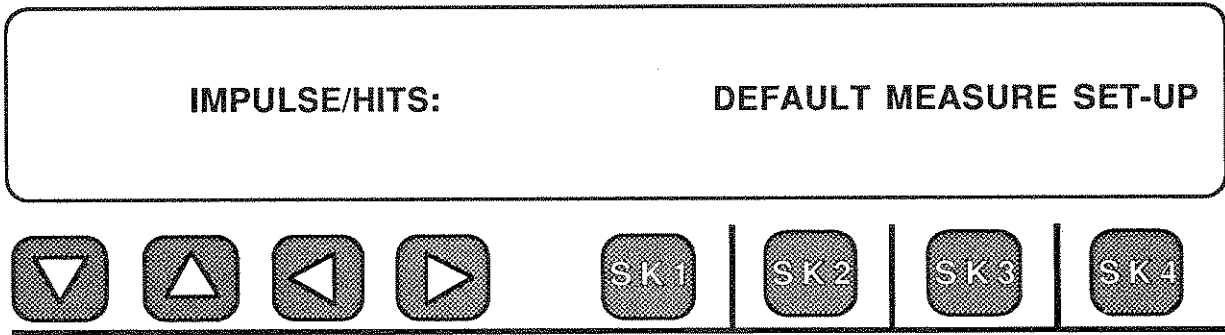

If you press Softkey 3 (under **MEASURE**), the 930A display will become:

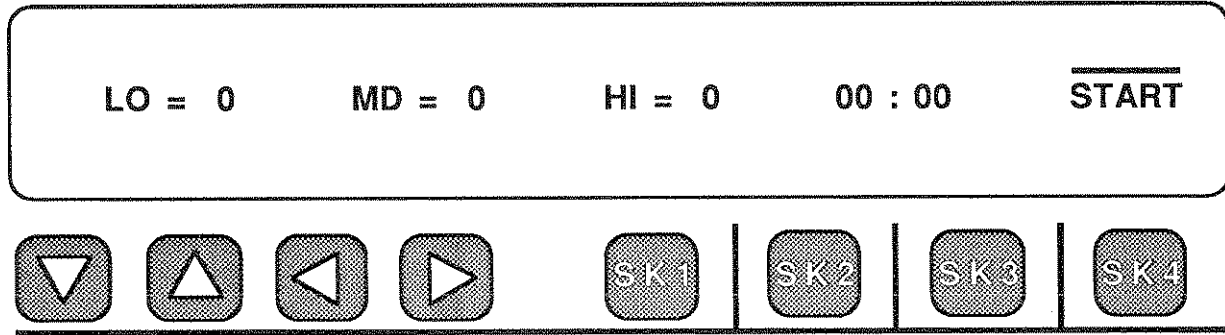

Press Softkey 4 (under **START**) to begin measurements.

If you want to use parameters other than the factory defaults, then you have to go through the manual set-up procedure. The main display is repeated below for example purposes:

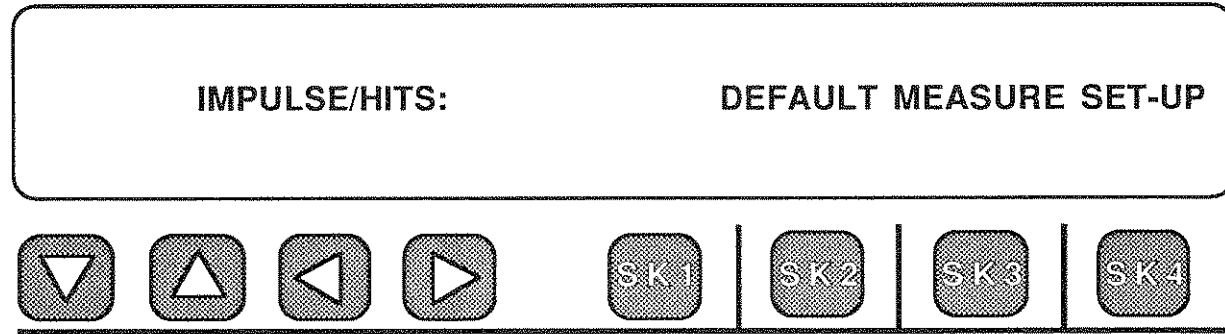

The following step-by-step procedure assumes that the test parameters have not yet been set up and it is not desired to use the defaults.

Press Softkey 4, (under **SET-UP**), and the 930A display will appear as follows:

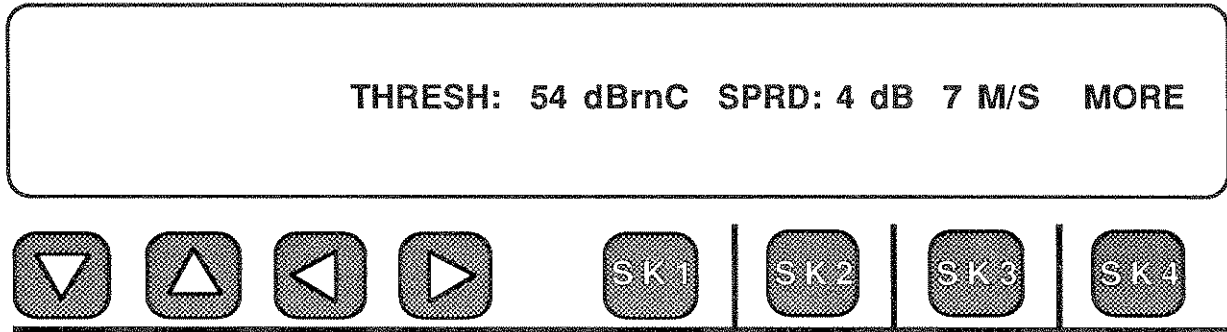

This display presents you with the current settings of the Impulse Noise and Hits parameters and lets you make other choices. In this section, we are concerned only with setting the Impulse Noise parameters.

There are four Impulse Noise parameters which can be changed from their default values. You may change any or all of them. You start the process by pressing the softkey directly below the parameter you want to change.

To begin changing the values:

Press Softkey 1 (under THRESH: 54 dBrnC) and the 930A display will change to:

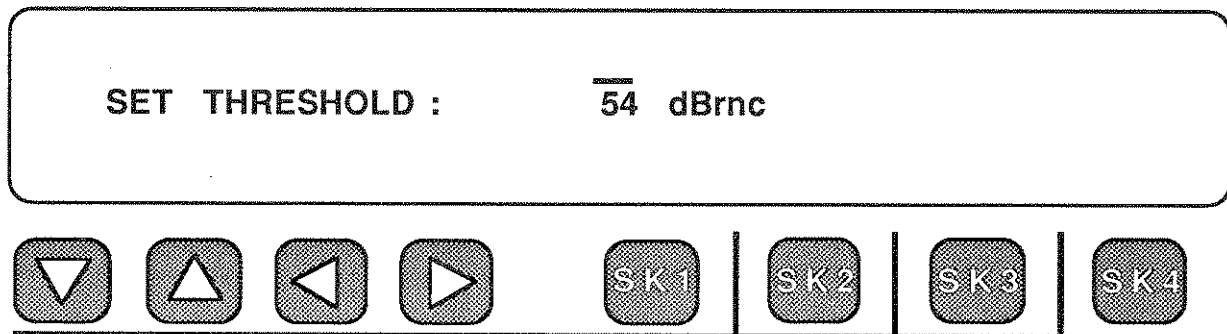

The range of threshold settings permitted for the lowest threshold is 30 to 106 dBrnC, assuming the spread between thresholds is 2 dB. No threshold can be higher than 110 dBrnC, so a wider spread creates a lower limit for the initial threshold.

Suppose you want 58 dBrnC as the lower threshold. To change to this value, perform the following steps:

Press **5** and **8** and then **ENT**

and the 930A display will show:

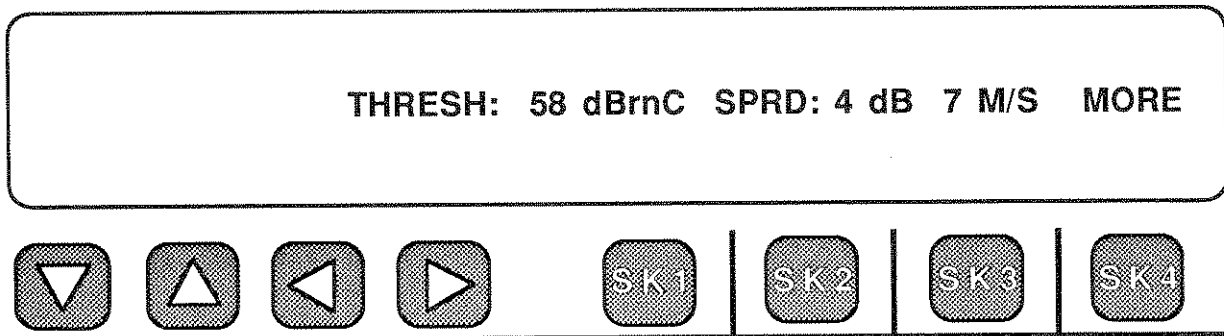

The new threshold value is now displayed and the impulse noise counters are now set to 58 dBrnC, 62 dBrnC, and 66 dBrnC since the spread is still 4 dB.

To change the size of the spread between the Low, Mid, and High impulse noise measurement counters, **press Softkey 2** (under **SPRD: 4 dB**) and the 930A display will change to:

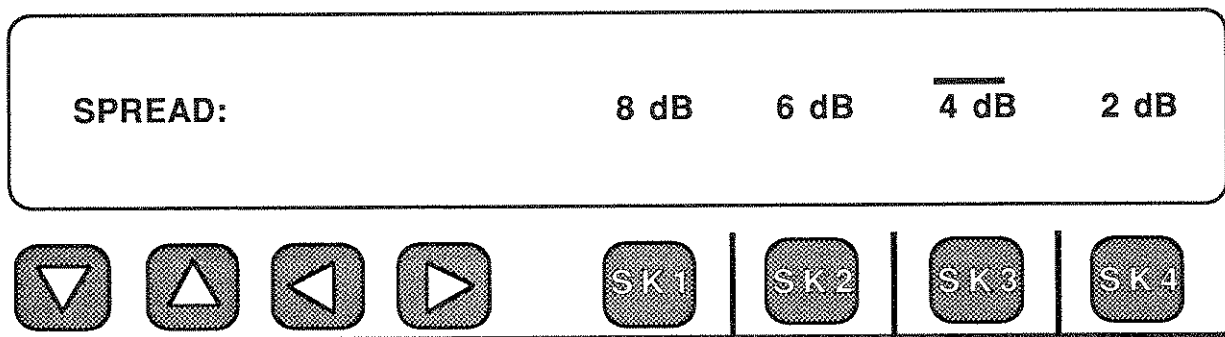

The flashing cursor appears over the currently selected step size (4 dB in this example). The step size choices range from 8 dB to 2 dB in 2 dB increments and each choice appears directly above it's associated softkey.

To choose a step size of 6 dB instead of the 4 dB value, press Softkey 2 (under 6 dB) and the 930A display will change to:

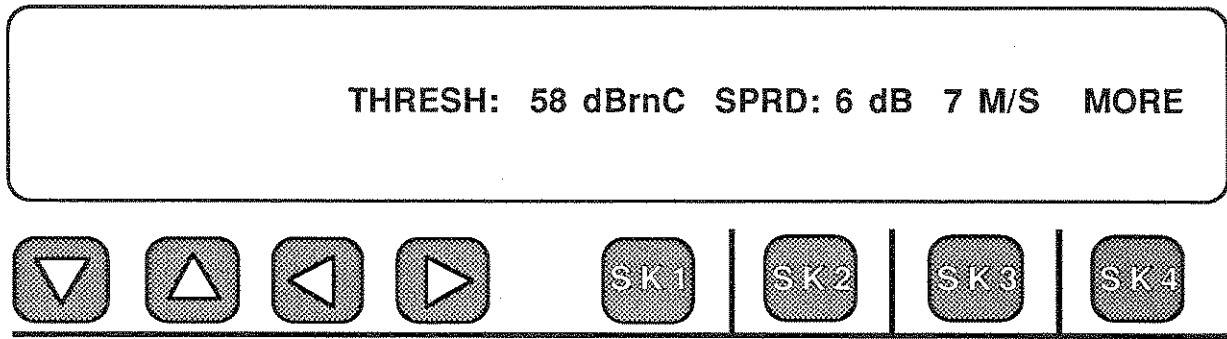

The Spread is now 6 dB and the counter thresholds will now be set at 58 dBrnC, 64 dBrnC, and 70 dBrnC.

To change the number of measurements per second which the 930A makes, press Softkey 3 (under 7 M/S). The standard value is 7 measurements per second but other common values are; 8 measurements per second, and what is called a "channel limited" measurement. To change the number of measurements per second, do the following:

Press Softkey 3 and the 930A display will change to:

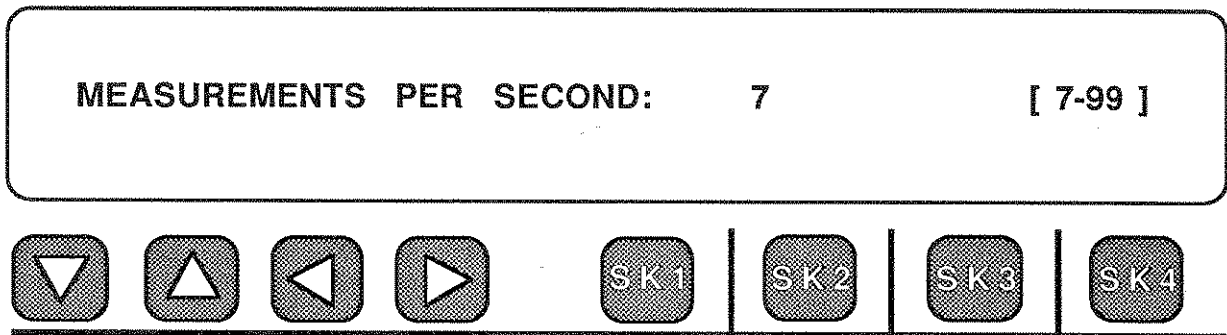

The acceptable values range from 7 measurements per second to 99 measurements per second. If you want to set in a value of 8 measurements per second, for example, then do the following:

Press **8** and then **ENT**

The 930A display will change to the one shown on the following page.

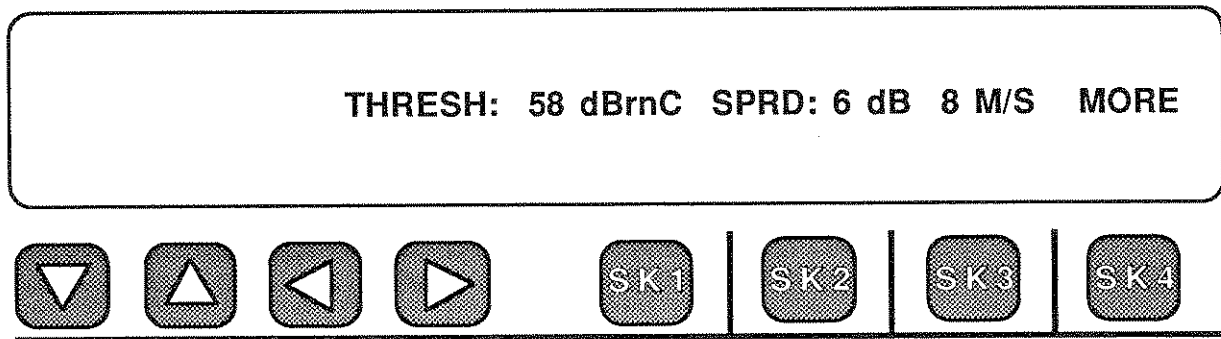

To change the measurement time period, press Softkey 4 (under MORE) and the 930A display will show:

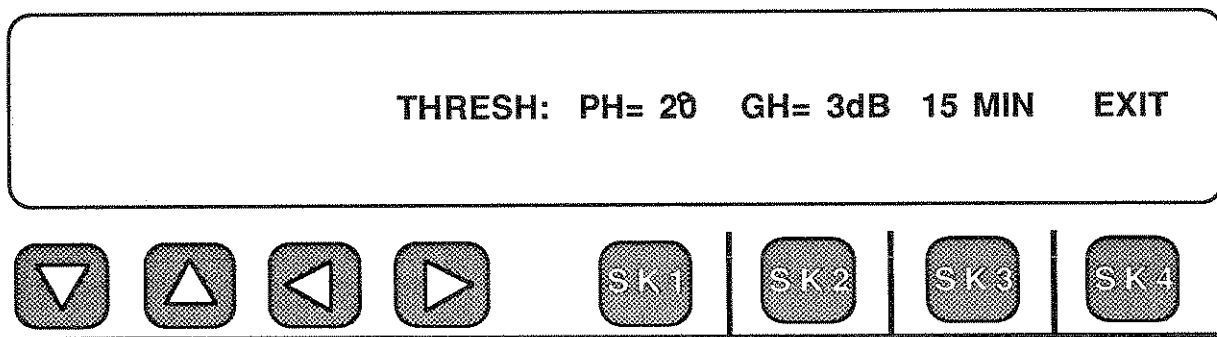

The standard value used is 15 minutes, however, the Model 930A can make timed measurements of Impulse Noise from 1 minute duration to 99 minutes duration or it can be set to continuously measure.

Suppose you want a 5 minute test length. Press Softkey 3 (under 15 MIN) and the 930A display becomes:

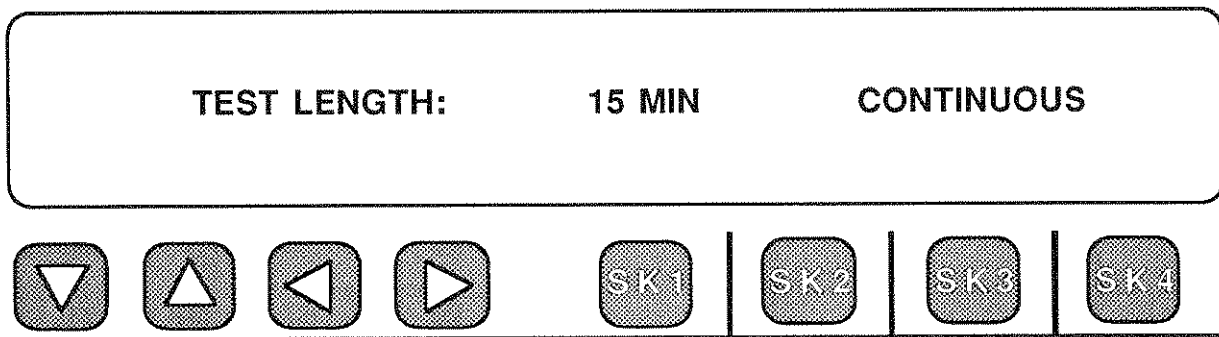

Press **5** and then **ENT**

and the 930A display changes to:

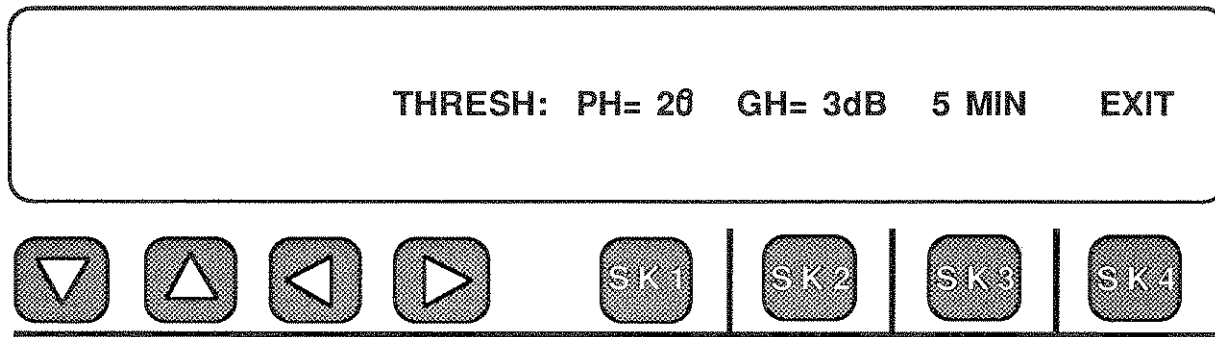

All of the Impulse Noise measurement parameters have now been changed. You are free to select other values within the acceptable ranges given for each parameter. This example was intended only to show the method.

When you have set-up the Model 930A, press Softkey 4 (under **EXIT**) in the above display. The 930A will go to the measurement display shown below:

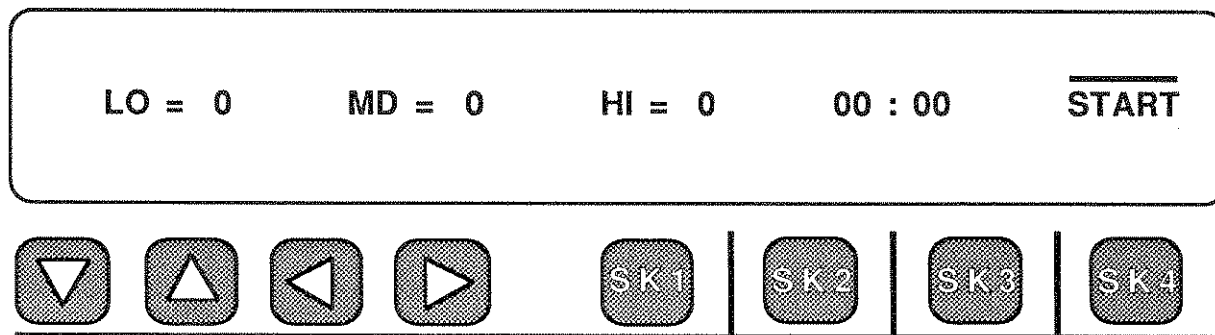

Pressing Softkey 4 (under **START**) begins the measurements.

After some time has elapsed (remember that this example has set a 5 minute measurement time), a typical display might appear as:

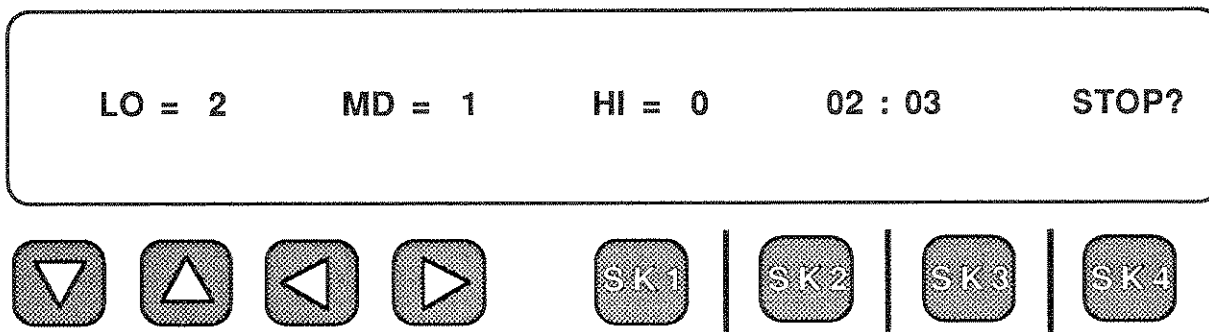

This display shows that after 2 minutes and 3 seconds of testing, there have been 2 impulse noise bursts that have exceeded the 58 dBrnC threshold, 1 that has exceeded the 64 dBrnC threshold, and none that has exceeded the 70 dBrnC threshold. This test would continue until 5 minutes had elapsed and then stop (time was set to 5 minutes in this example). You can stop the test at any time by pressing the **OPTION MENU** function key. The impulse counters have maximum values of 9999 impulses.

If the test is to be performed with holding tone over a loopback circuit, the 930A should be set to send 1004 Hz at -13.0 dBm using the **SEND TONE** function. The words "NO TONE!" will appear above Softkey 4 if the holding tone drops below -40.0 dBm at any time during the test, as shown below:

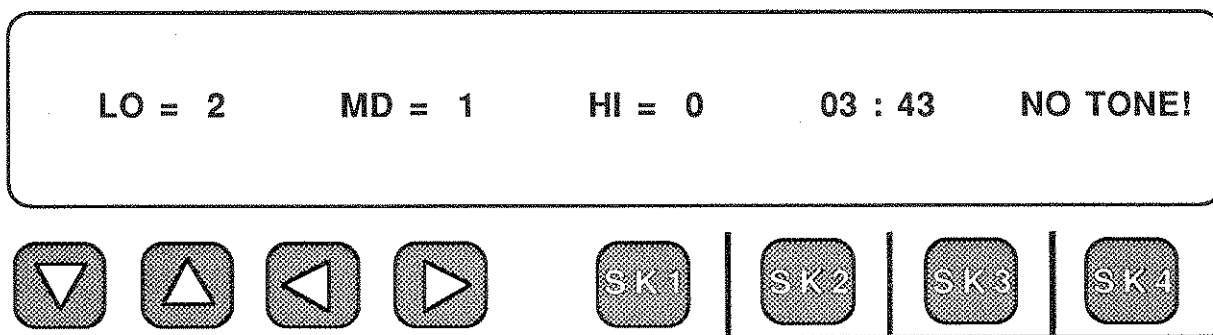

The default value of low threshold used by the 930A is 54 dBrnC0 which is the setting for voice frequency metallic cable facilities less than 500 miles in length. This threshold assumes the use of a -13 dBm0 holding tone.

If you have selected the **PCM or T-1 Carrier** trunk interface, then the 930A will select 67 dBrnC0 as its low threshold when **DEFAULT** is pressed. This is the correct low threshold on T-Carrier circuits.

Other commonly used low thresholds are: **59 dBrnC0 for PBX tie trunks** and **67 dBrnC0 for mixed metallic and T-1 carrier facilities** less than 500 miles long.

The maximum impulse counts allowed, without exceeding maintenance guidelines over a 15 minute period, relate to the threshold and step size. The following values come from the pre-divestiture days and are:

| | |
|------------------|-------------|
| Threshold | < 15 counts |
| Threshold + 4 dB | < 9 counts |
| Threshold + 8 dB | < 5 counts |

The overall end-to-end low threshold at the customer premises is usually 71 dBrnC0. The end-link low threshold alone is usually 67 dBrnC0. The mid-link low thresholds are based on mileage, and range from 54 to 73 dBrnC0. The diagram below explains the terminology of end-links and mid-links.

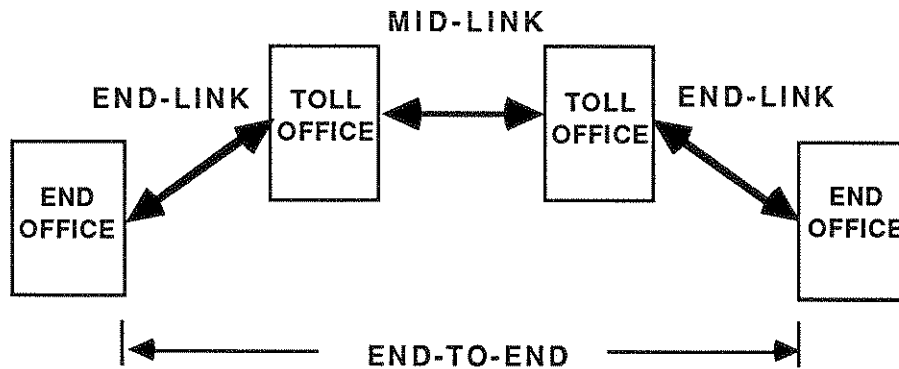



5-11.1 PHASE HITS, GAIN HITS AND DROPOUTS

The measurement of the transients known as Phase Hits, Gain Hits, and Dropouts requires that Option 930A-07 (3-Level Impulse Noise) be installed in the 930A as well as Option 930A-18. These measurements are performed in conjunction with Impulse Noise measurement and are displayed as a sub-menu of the Impulse Noise display.

To begin testing perform the following steps:

Press the OPTION MENU  Option Menu function key.

Use the UP/DOWN   arrow keys to
select Menu Option 11: IMPULSE NOISE & HITS.

The Model 930A display will appear as:

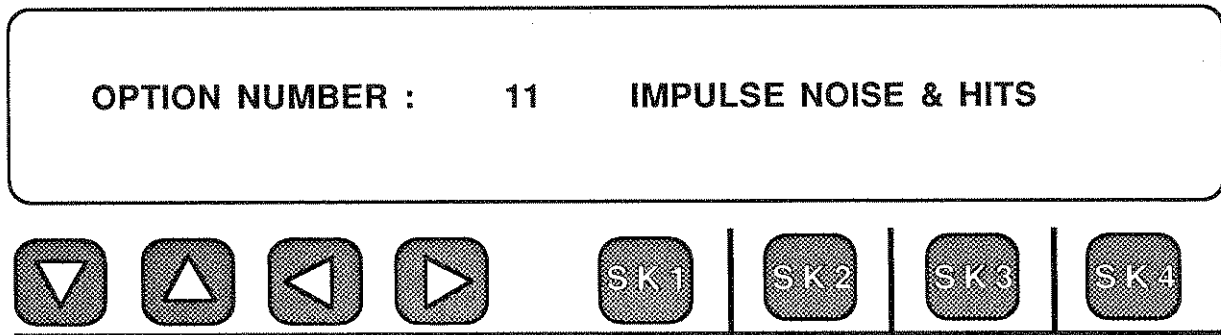

Press any softkey under the display and it will become:

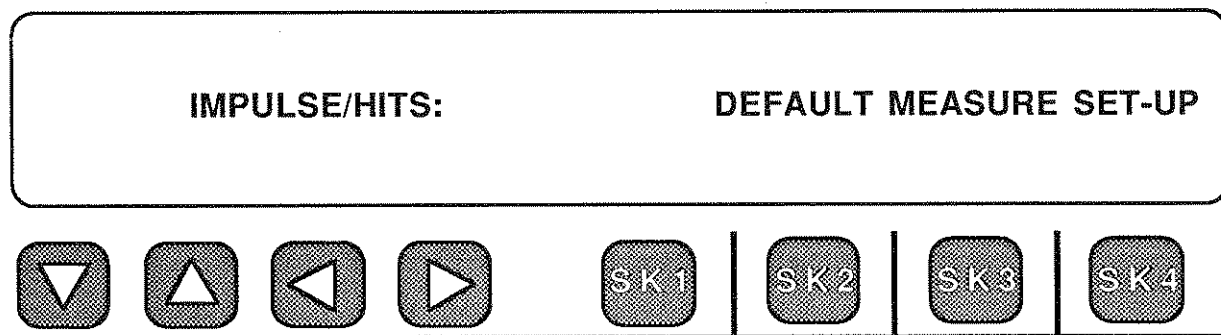

Softkey 2 (under **DEFAULT**) sets all the test parameters such as thresholds and time intervals to the factory defaults for the **TRUNK TYPE** selected. Pressing Softkey 2 causes the 930A to momentarily display the message:

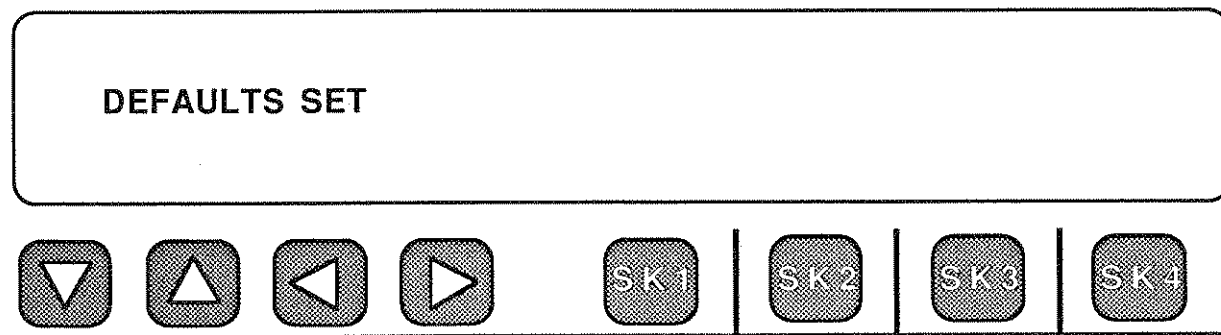

This also provides a convenient way to restore previously entered settings to the factory default values

5-12 TO MARGIN THE WINK DURATION OF THE 930A (MENU OPTION 12)

The Model 930A includes **Wink Margining** as part of Option 930A-01 (**MF, DTMF, and DP Receiver/Analyzer**). **Wink Margining** lets you change the default of the length of time the 930A will wait (200 milliseconds) after it sees a seizure before it gives back a **Wink**. This is called the **Pre-Wink** time or **Guard** time. You can also change the duration or length of the **Wink** itself (150 millisecond default).

You select Menu Option 12 in the same manner as any other Menu Option by the following steps:

Press the OPTION MENU  **Option Menu** function key.

Use the UP/DOWN   arrow keys to select Menu Option 12: WINK MARGINING.

The 930A display will appear as shown below:

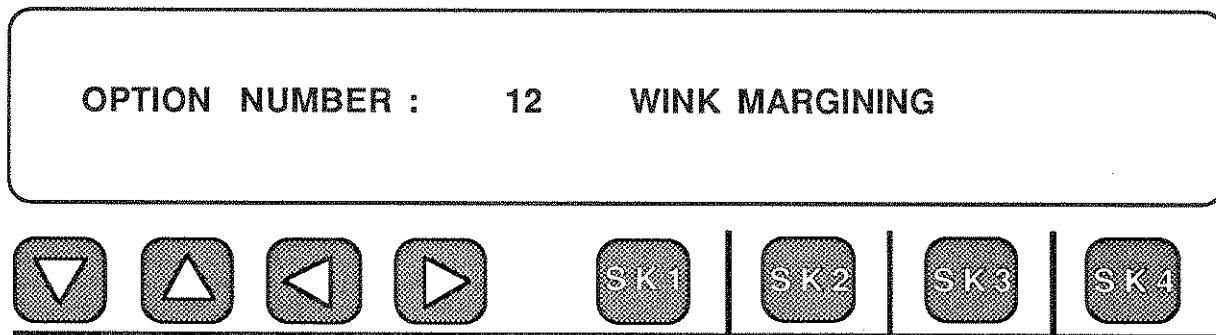

You get inside the Menu Option by pressing any softkey under the display.

Inside Menu Option 12, the display will first show either the default value of the "Pre-Wink", or the last value entered.

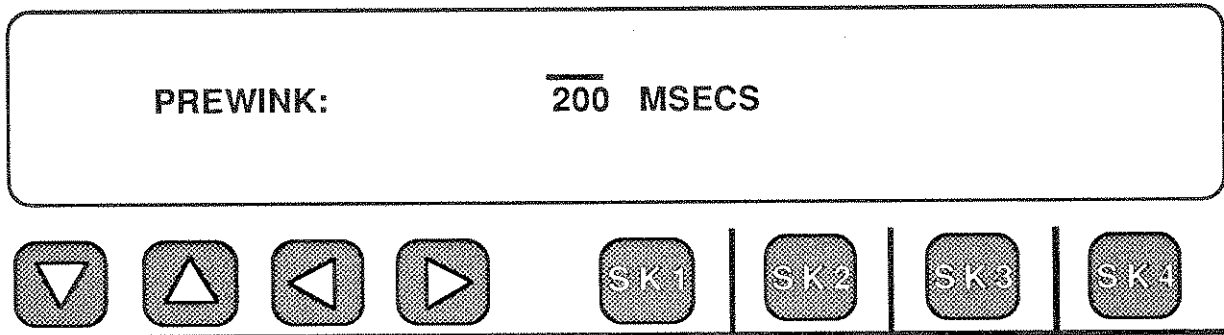

The "Pre-Wink" time is the number of milliseconds the 930A will wait after line seizure (or the end of a record) before giving a wink. The range of permissible values lies between 55 and 995 milliseconds. The factory set default value is 200 milliseconds. This Menu Option has a resolution of 10 msec. and an accuracy of 10 milliseconds. The front panel keys function as follows: To change the displayed **Pre-Wink** time, you enter the value you want from the keypad and then press the **ENTER** key. If you want to keep the default value, press **ENTER** or any softkey. In either case the display will advance to the **Wink** time.

The display will then read the **Wink Time** default value of 150 milliseconds, or the last value entered:

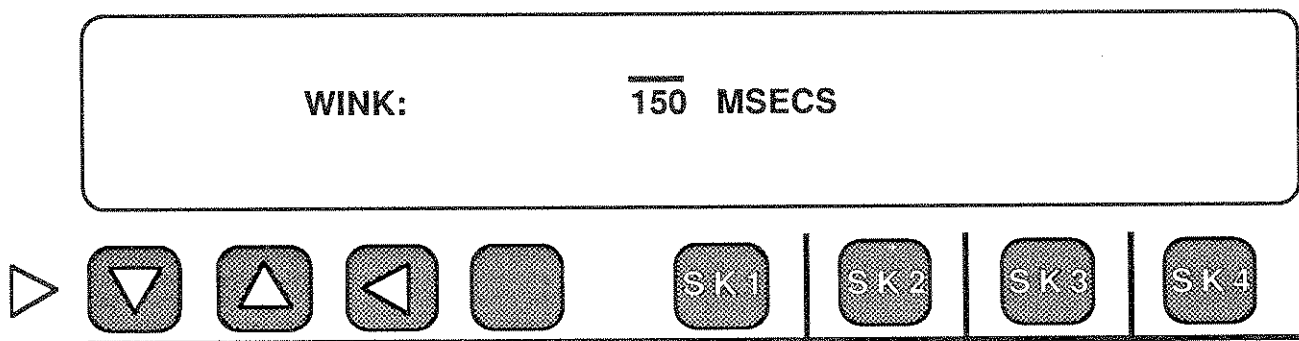

This is the number of milliseconds the 930A will remain Off-Hook during a Wink. The range of permissible values lies between 35 and 995 milliseconds. The factory set default value is 150 milliseconds. The accuracy is 10 milliseconds and the resolution is 10 milliseconds.

WINK: 150 MSECS

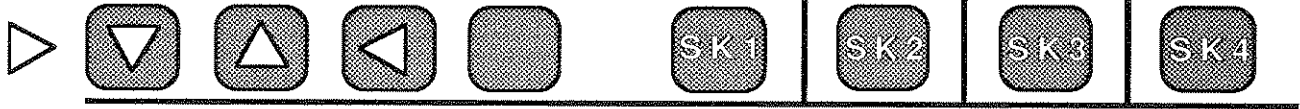

To change the displayed value of the Wink, enter the value you want the 930A to use from the keypad, and press **ENTER**. If you want to keep the default, just press **ENTER**, or any softkey. Either action will exit to the Option Menu.

OPTION NUMBER : 12 WINK MARGINING



5-13 PHASE/AMPLITUDE JITTER AND HITS (MENU OPTION 13)

Option 930A-18 works in conjunction with Option 930A-07 (Impulse Noise) to provide the capability to measure Phase and Amplitude Jitter on Voice Frequency channels as well as transient phenomena such as Phase Hits, Gain Hits, and Dropouts.



The Phase and Amplitude Jitter measurements are displayed under Option Menu 13 and the Hits are counted with Impulse Noise under Option Menu 11.

Connect the 930A to the trunk under test prior to setting up these measurements. In the case of Phase Jitter measurements however, it is **also necessary to perform a C-Message Noise measurement prior to measuring Phase Jitter. Excess noise can cause what appears to be significant amounts of jitter.**

5-13.1 TO MEASURE PHASE/AMPLITUDE JITTER

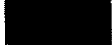
After making a C-Message noise test (readings should be less than 20 dBnC for quiet terminated line), do the following to select the Phase/Amplitude Jitter mode:

Press the OPTION MENU  Option Menu function key.

Use the UP/DOWN   arrow keys to select Menu Option 13: PHASE & AMPL JITTER.

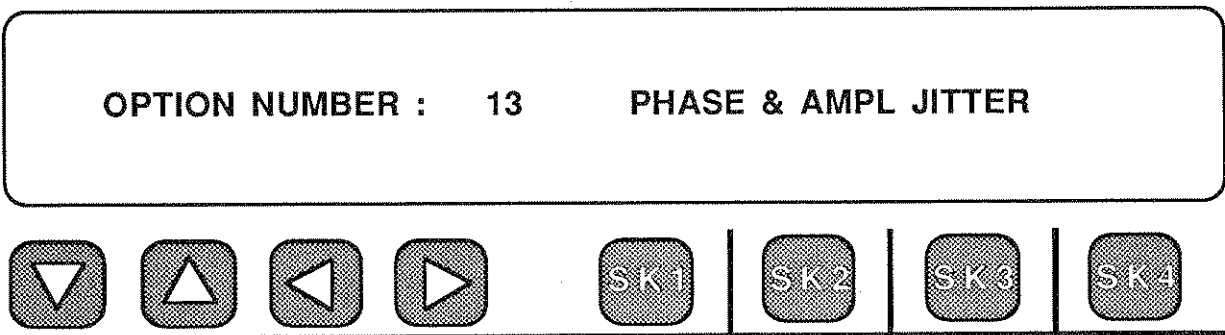

Press any softkey under the display to immediately begin measurements:

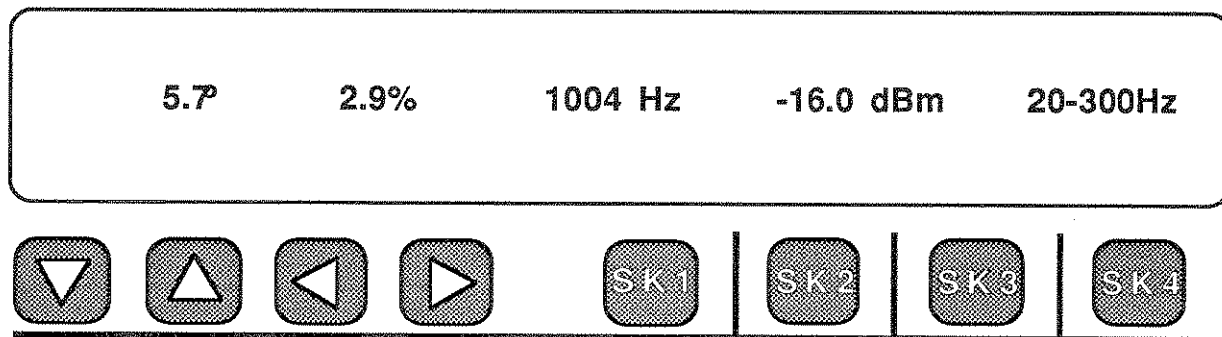

The 930A begins measuring Phase and Amplitude Jitter over the filter bandwidth of 20 Hz to 300 Hz. It also displays the level and frequency of the received holding tone (usually 1004 Hz).

There is a good deal of phase jitter on the trunk in this example. The full jitter measurement bandwidth (4-300 Hz) provides an overall picture of the jitter situation. **The next step** is to try to determine the source of the jitter. **Press Softkey 4** (under 20-300 Hz) to change the filter bandwidth selection from 20-300 Hz to 4-300 Hz. Assume that the 930A displays the following measurements:

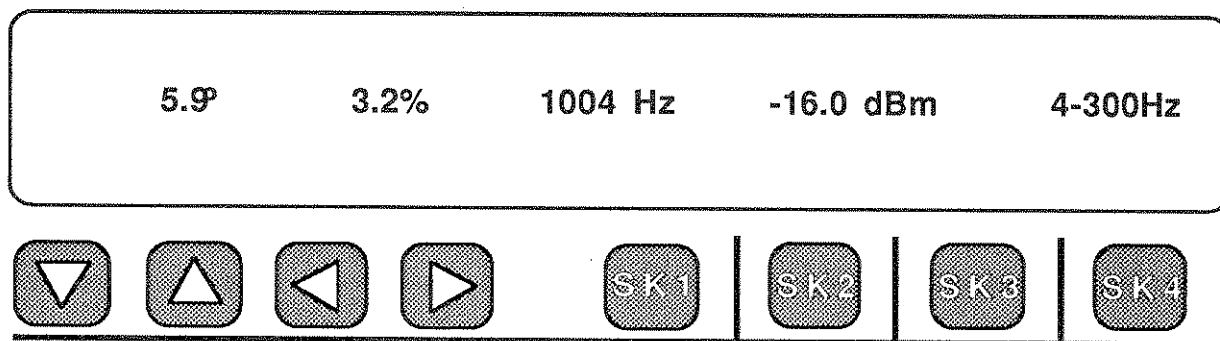

In this case, there is not significant change in either the 4-300 Hz or 20-300 Hz band readings. The interpretation of these results is relatively straightforward now that the measurements have been made. The fact that the readings are relatively the same suggests that the source of the excess jitter has a fundamental frequency above 20 Hz since there are no significant contributions to the levels from below 20 Hz.

Between 20 Hz and 300 Hz the most significant source of jitter is the 60 Hz AC power line frequency and its second through fifth harmonics (120 Hz, 180 Hz, 240 Hz, 300 Hz).

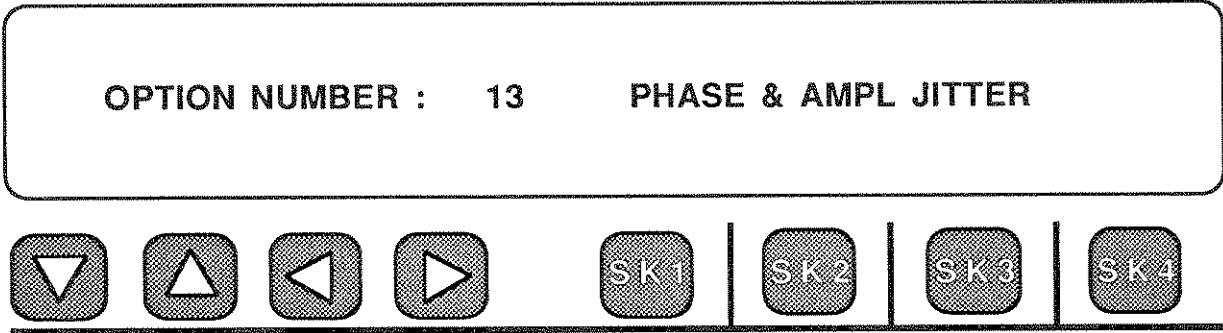

To stop testing and return to the main menu, press the **OPTION MENU** key.
The 930A display will return to:



5-14 SETTING THE TIME AND DATE (OPTION MENU 14)

To set the Time and Date, perform the following steps:

Press the OPTION MENU  Option Menu function key.

Use the UP/DOWN   arrow keys to select Menu Option 14, SET TIME AND DATE.

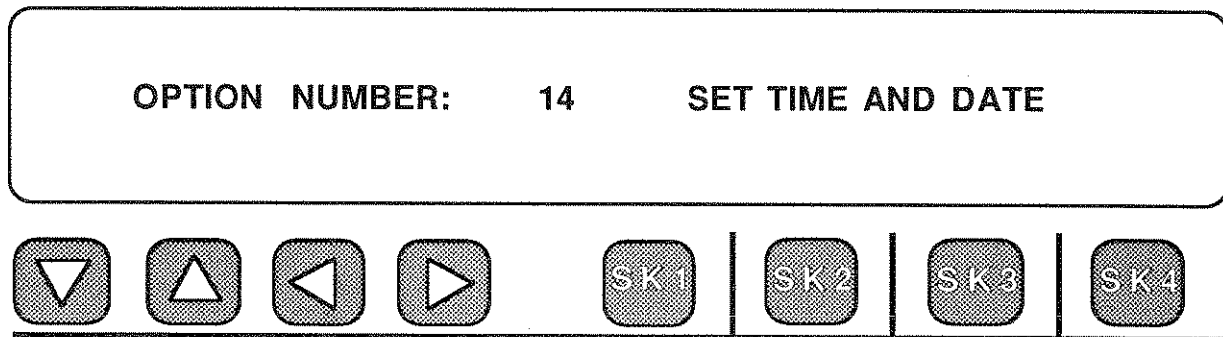

Press any softkey under the display and the currently stored time and date will be displayed. The cursor always appears over the day of the week.

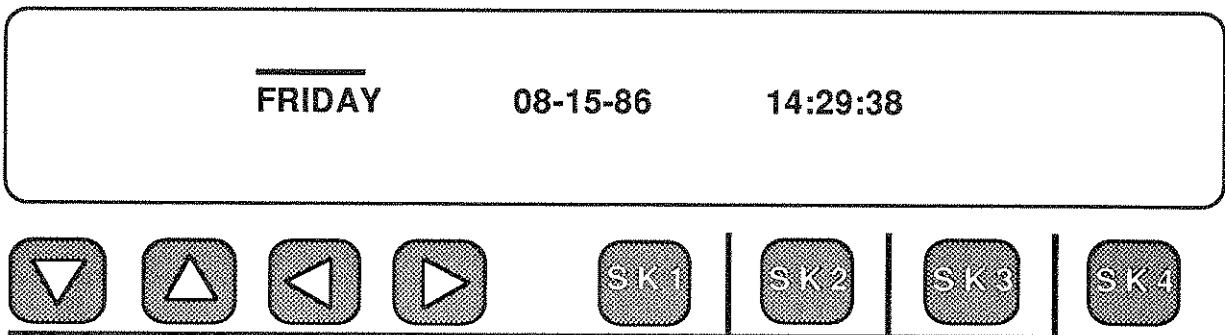

Use the LEFT/RIGHT   arrow keys

to position the cursor over the day, date or time parameter it is desired to change.

Use the UP/DOWN   arrow keys

to change the parameter under the cursor.

For parameters other than the day of the week, you may enter a number directly using the keypad and the **ENT** key. The cursor will automatically advance to the next field.

As an example, suppose it is desired to advance three hours to compensate for a time zone change from west coast to east coast time.

Use the **RIGHT** Arrow key to position the cursor over the "14" as shown:

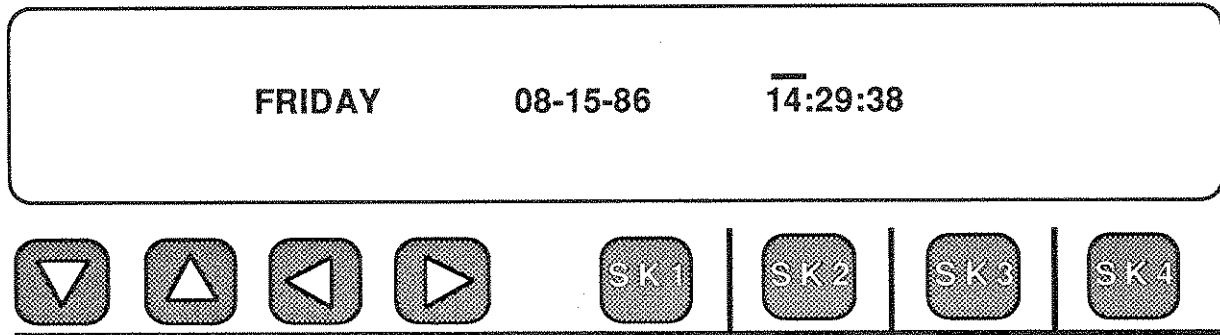

Use the **UP** arrow key to advance the hour to 17 as shown below:

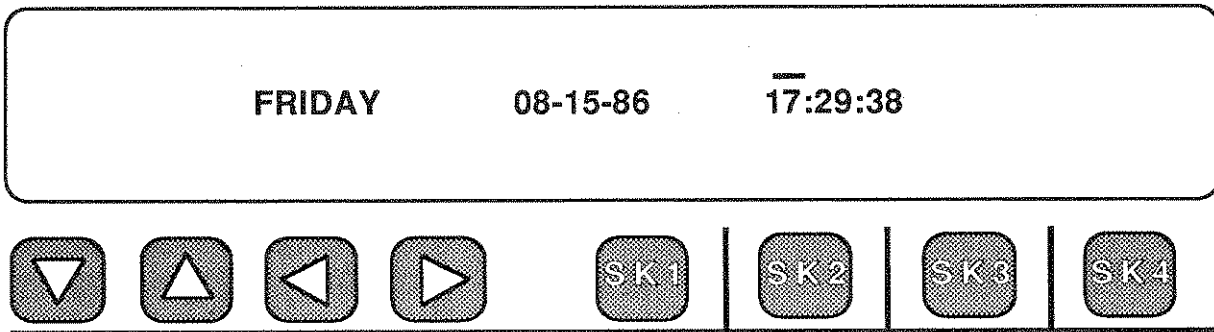



When the correct time and date have been set, press the **OPTION MENU** key to exit.

5-15 HOW TO STOP THE 930A FROM BEEPING (MENU OPTION 15)

Menu Option 15: **BEEP ON ERROR** provides you with an audible indication of various types of errors. These include errors of commission such as, trying to select a Trunk Type option that has not been installed. Since there are times when you don't care to listen to the beep, this Menu Option provides the means to turn off the beep without cutting the wires to the speaker. To control the **BEEP**, do the following:

Press the OPTION MENU  **Option Menu** function key.

Use the UP/DOWN   arrow keys to
to select Menu Option 15: **BEEP ON ERROR**.

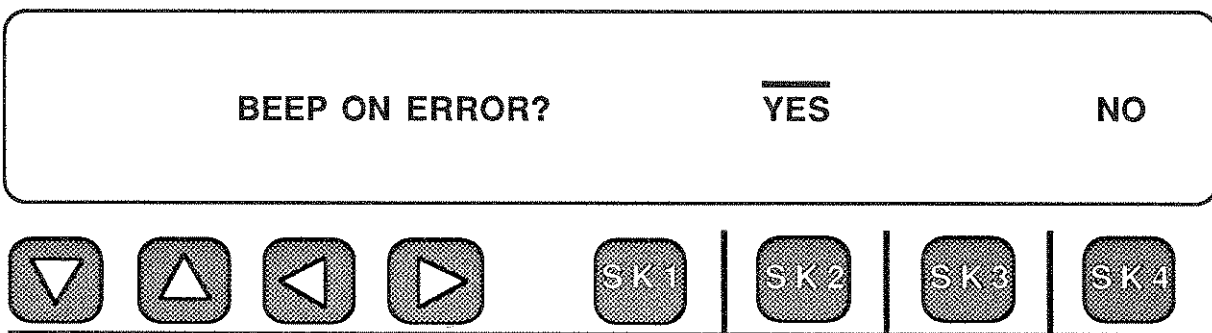

If the cursor appears over the **YES** field, the **BEEP** has been turned **on**. To turn it **off**, press Softkey 4. You are now free to make all the operating mistakes you want without the annoying **BEEP** to disturb you. To turn the **BEEP** back on, return to Menu Option 15 and, once inside the menu, press Softkey 2. If you have ordered Option 930A-10C (Remote Control), disabling the beep also prevents the 930A from sending the "Bell" character (ASCII 07) to a remote printer, terminal, or computer.

Most of the time **BEEP** is encountered when using the 930A with the PCM interface (Option 930A-08E or -09E). Usually it is because you don't have the 930A hooked into a span, so it has no PCM input and wants to tell you. You can shut up the **BEEP** in this case by looping **PCM IN 1** to **PCM OUT 1**, and setting the 930A to **TERMINATE** and **INTERNAL** clock, which gives it a signal. The beep interval is now 4 seconds long. Pressing any front panel key will add another 4 seconds which enables you to set up the 930A in peace.

5-16 DIGIT RECEIVER TIMEOUT (MENU OPTION 16)

Option Menu 16: DIGIT RECEIVER TIMEOUT allows the 930A to set a timeout from 0.2 to 60 seconds for the digit receiver. If the timeout elapses while the digit receiver is expecting a digit, the 930A closes the digit record. This allows the digit receiver to be used more easily when DTMF or dialpulse digits are expected and the user does not know for sure just how many digits are being used.

Press Option Menu 16 and press **ENTER**. The following screen will be displayed:

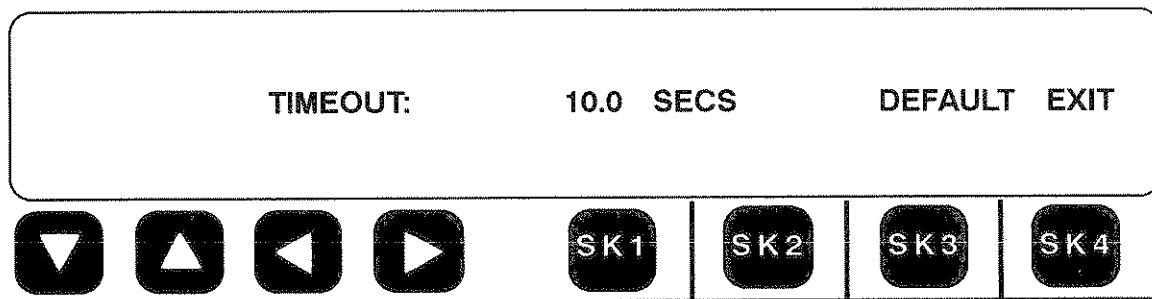

Press **DEFAULT** or determine the timeout length required. Enter change using the Keypad. Press **EXIT** when complete.

5-17 ENVELOPE DELAY DISTORTION (MENU OPTION 17)

Envelope Delay Distortion (EDD) is always an end-to-end test. It requires test sets at both ends of the circuit and a 4-wire transmission path. One end is set up in the **REPEAT** (or Slave) mode. The other end is set up in **SEND** (or Master) mode. The **SEND** unit transmits a single frequency (usually 1804 Hz) to establish a reference delay. This delay is "zeroed out", and the **SEND** unit sends a frequency sweep, measuring delay in microseconds relative to the reference. Then the **SEND** end transmits the reference frequency while the **REPEAT** end sweeps the returned carrier. All delay measurements are made at the **SEND** end. These tests are often referred to as **RETURN REFERENCE** and **FORWARD REFERENCE** measurements.

The measurement proceeds as shown below:

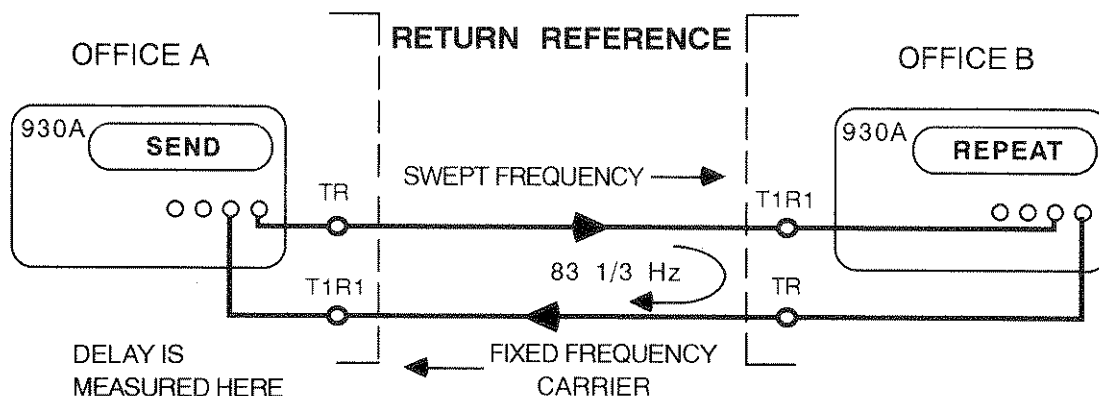

- 1) Office A sends an amplitude-modulated signal over the trunk under test.
- 2) Office B strips off the modulation and applies it to a carrier.
- 3) Office A recovers the returned modulation and compares it to that being sent. The difference in phase is proportional to the envelope delay.
- 4) The delay at a reference frequency is used as a zero reference, and a frequency sweep is then performed by the **SEND** unit. The delay at the other frequencies is measured in microseconds relative to the reference.

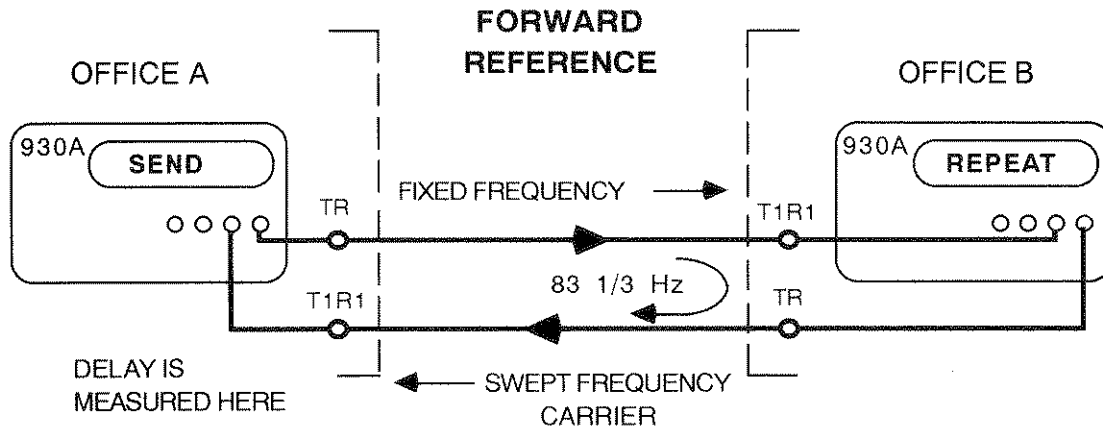

- 5) The **SEND** unit sends the reference frequency while the **REPEAT** unit sweeps the returned carrier. This allows the **SEND** unit to measure the delay on the return path.

5-17.1 MEASURING ENVELOPE DELAY DISTORTION

To make an Envelope Delay measurement, perform the following steps:

Make sure that the 930A at each end of the circuit is set to the correct Trunk Type and impedance (Refer to Section 3-4). Use the **DIAL/RING** function to place a call over the trunk under test. With both units off hook in the **DIAL/RING** function, a voice path is available through the front panel Tel-Set jacks. A handset can be connected to allow coordinating the test activities with the far-end if a separate voice path is not available. Decide at this point which unit will be the **SEND** end, and which will be the **REPEAT** end.

Press the OPTION MENU  Option Menu function key.

Use the UP/DOWN   arrow keys to select Menu Option 17: ENVELOPE DELAY.

The 930A display will appear as shown below:

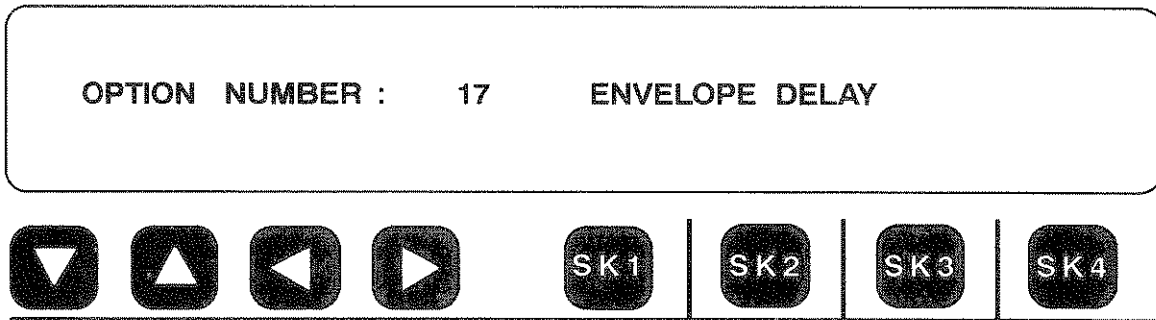

To enter the menu, press any softkey and the 930A display will change to the display below:

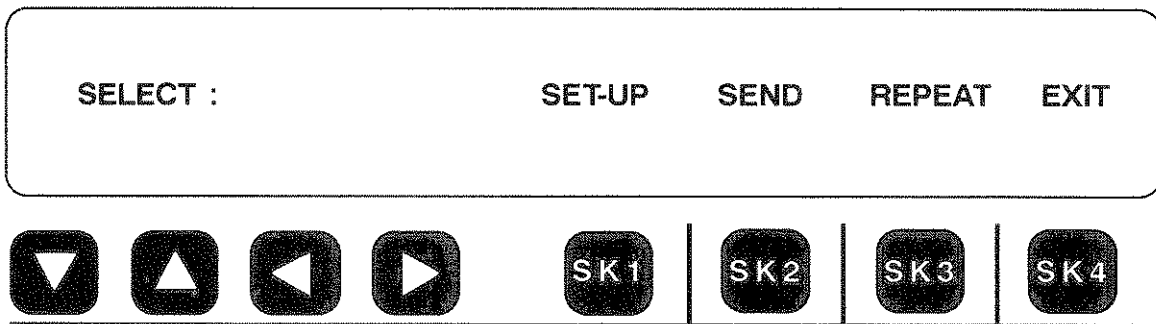

At this point, you can change any, or all, of the test parameters, or go directly to the measurement mode. If the test set-ups have been previously entered, and have not been changed, it is not necessary to re-enter the set-up mode. The 930A remembers the test set-ups.

SETTING UP A SWEEP:

To enter the Set-Up menu, press Softkey 1 (under **SET-UP**) and the display will change to:

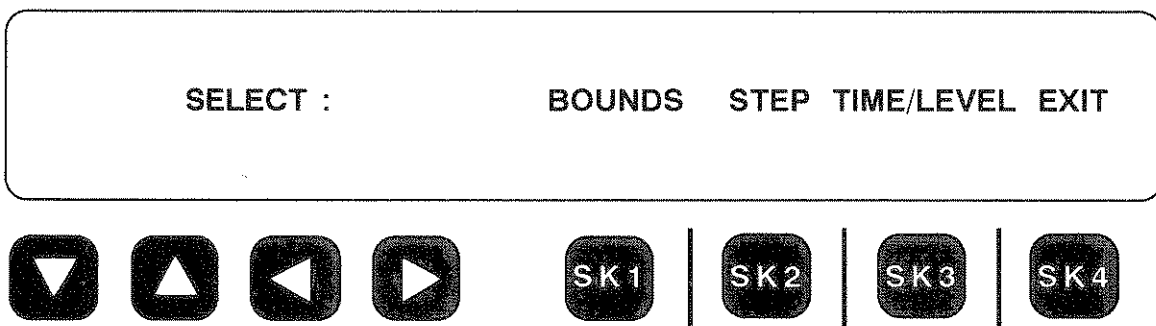

The **930A default parameters** have been preset to sweep from 304 Hz to 3204 Hz in 100 Hz steps at a level of -16 dBm and a time between steps of 3.5 seconds with the SF frequency band skipped. A typical Envelope Delay measurement would use these default settings. You **do not** need to enter the **SET-UP** menu unless you want to change these settings.

Some C-Conditioned line tariffs specify performance out to 3504 Hz. Also, older vintage test equipment operated at 5 seconds between steps and it is possible that a different test set than the 930A may be at the far end of the circuit. For these reasons it is good to know how to change the test set-ups.

To change the ending frequency bound from the 3204 Hz default value to 3504 Hz return to the **SELECT** display repeated below:

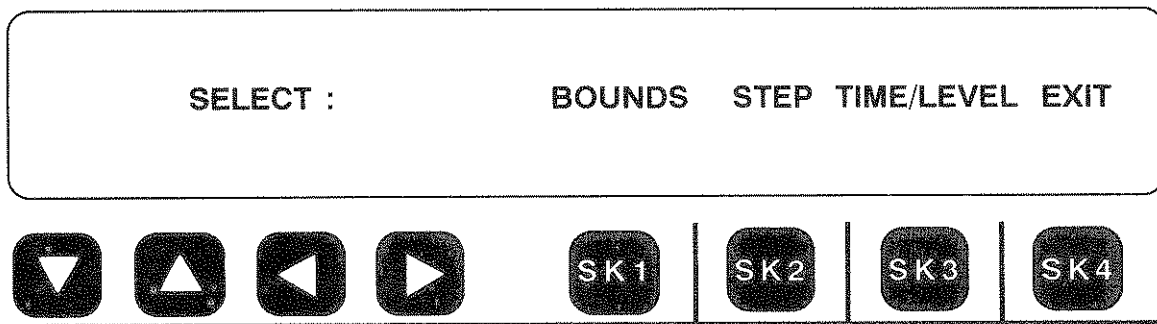

Pressing Softkey 1 (under **BOUNDS**) will bring up the following display:

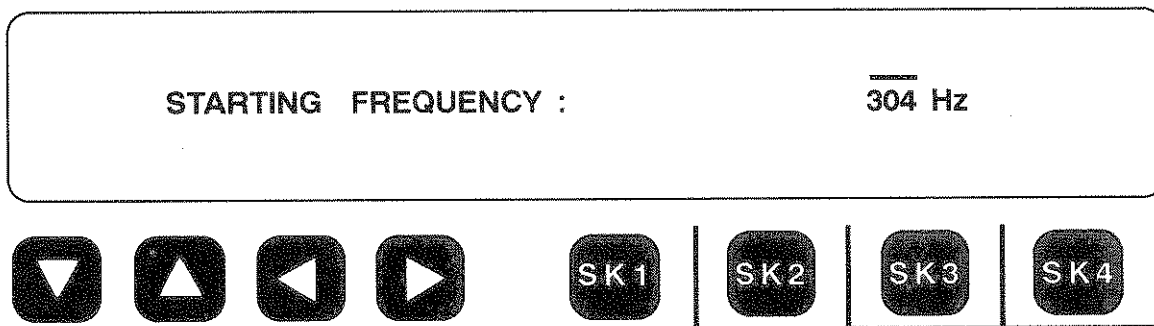

Press Softkey 3 (under **304 Hz**) to keep this value for our example. The display will advance to the next choice.

| | |
|--------------------|----------------|
| ENDING FREQUENCY : | <u>3204</u> Hz |
|--------------------|----------------|



This value is to be changed to 3504 Hz. Press **3**, **5**, **0** and **4** on the numeric keypad and press the **ENTER** key. The 930A will advance to the **Skip SF** display below:

| | | |
|---------------|------------|----|
| SKIP 2600 Hz? | <u>YES</u> | NO |
|---------------|------------|----|



Press Softkey 2 to **SKIP SF**. The 930A will return to the **SELECT** display repeated below:

| | | | | |
|----------|--------|------|------------|------|
| SELECT : | BOUNDS | STEP | TIME/LEVEL | EXIT |
|----------|--------|------|------------|------|



You can change the step size from 100 Hz to any value between 1 and 999 Hz. The time between steps can be changed from 3.5 seconds to any value between 0.1 and 9.9 seconds. The level may be changed from -16.0 dBm to any value between 0 and -40 dBm. The procedure is the same.

Since this menu is taken directly from Menu Option 10: FREQUENCY SWEEP, levels may be entered from +12.0 dBm to -60.0 dBm and they will appear to be accepted. However, the 930A will only transmit over the 0 dBm to -40.0 dBm range allowed in Envelope Delay Distortion measurements.

Press Softkey 4 (under EXIT) when the sweep parameters have been set to the desired specifications. This returns the 930A to the main EDD selection display:

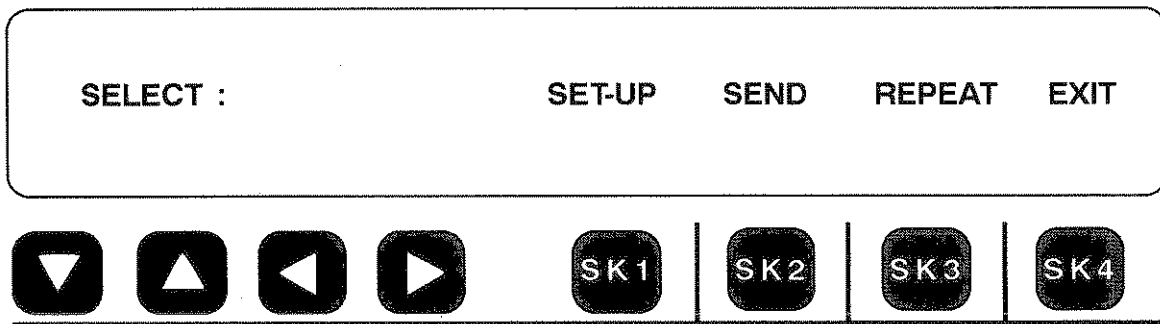

Again, once the 930A has been set up, it is not necessary to enter the set-up menu to start testing.

REMEMBER: One test set must be in the SEND, or MASTER, mode while the set at the other end must be in the REPEAT, or SLAVE, mode. Diagrams of test set-ups appear on pages 4-135 and 4-136.

The following sections explain the operation of the 930A when performing EDD measurements.

5-17.2 EDD MEASUREMENT IN THE SEND MODE

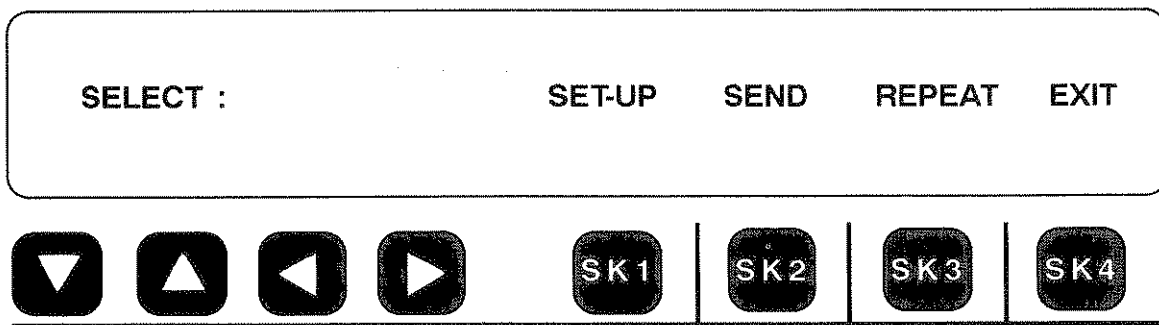

Starting from the main EDD selection display shown above, press Softkey 2 (under SEND) and a display similar to the following will appear:

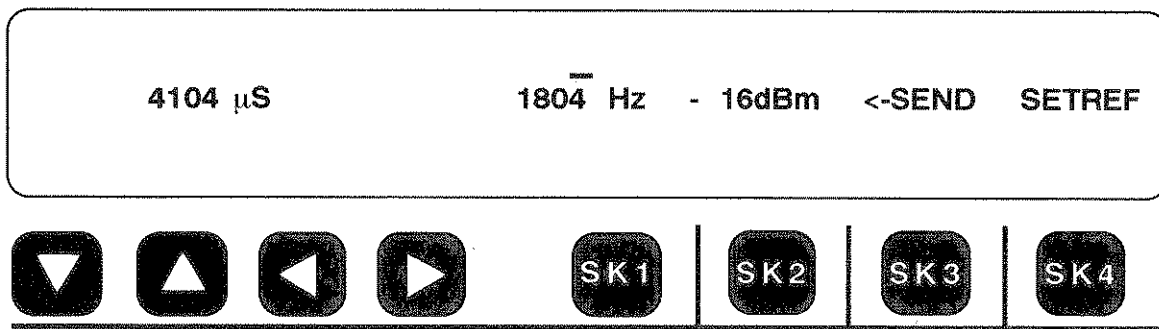

This display shows the calculated phase delay in microseconds for the return reference signal from the **REPEAT**, or **SLAVE**, unit and the level and frequency of the signal being sent from the **SEND**, or **MASTER**, unit. The usual reference (**FORWARD** or **RETURN**) signal is an 1804 Hz carrier at -16 dBm as shown above.

All measurements of **EDD** are made at the **SEND**, or **MASTER**, end of the circuit. **EDD** is also a referenced measurement. The first thing the 930A does when it enters the **SEND** mode is ask you to set the reference.

To change the reference frequency, press Softkey 1 (under the frequency). A highlighted cursor will appear over the last digit of the frequency (the "4" in this case) as shown above. Enter a new frequency using the keypad. Press the **ENT** key, or any softkey, to complete the entry. Only frequencies between 304 Hz and 3504 Hz are valid for this test.

To change the level, press Softkey 2 (under the level). A highlighted cursor will appear over the last digit of the level. Enter the new level using the keypad. Press **ENTER**, or any softkey, to complete the entry. Only levels between 0 dBm and -40 dBm are valid for **EDD** measurements.

To set the reference delay, press Softkey 4 (under **SETREF**) after allowing the delay reading to stabilize for a few seconds. The current envelope delay reading will become the reference and all subsequent measurements will be relative to this reference. This effectively "zeros out" the current measurement. Again, the normal convention is to "zero" the delay measured at 1804 Hz. The display should resemble that shown below.

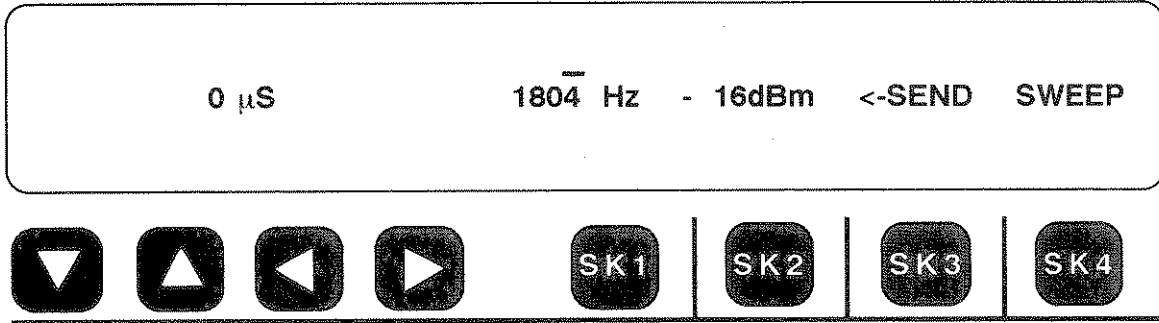

Once a reference has been established, the frequency or level of the outgoing reference signal can be changed or the frequency sweep can be generated. **To re-zero the reference without leaving the SEND mode**, press the CLR key. The current measurement will become the new zero reference.

To send a sweep and perform a Return Reference measurement after setting the reference delay, press Softkey 4 (now under **SWEEP**). The 930A display will now resemble the display shown below:

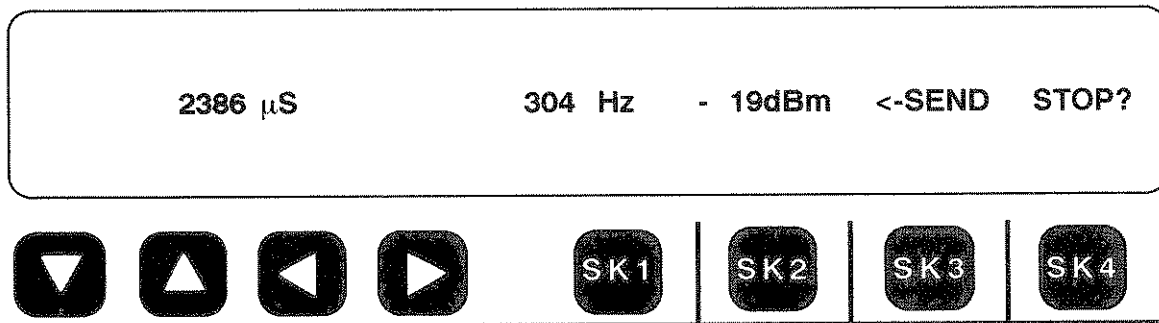
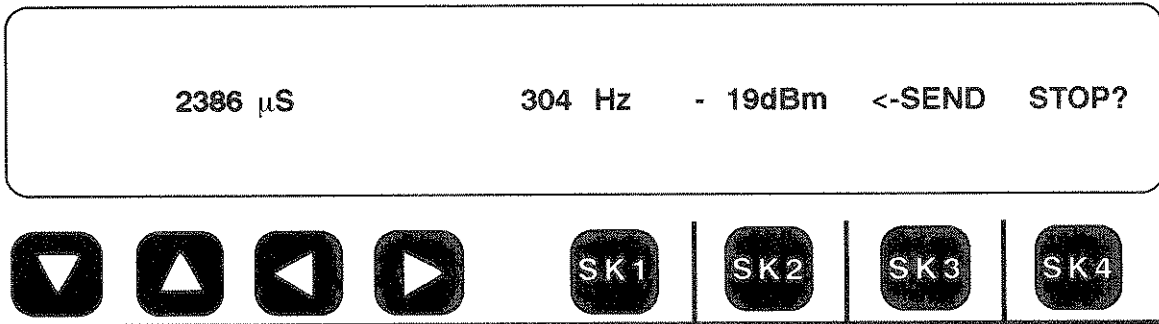

The sweep parameters which were set up earlier will automatically begin. The delay will be measured and displayed for each frequency in the sweep. If a terminal or 80 column printer is attached, and the 930A is in **PRINTER** remote mode (Requires Option 930A-10C), the 930A will automatically print the delay at each frequency of the sweep. **To interrupt the sweep**, without leaving the **SEND** mode, press Softkey 4 (now under **STOP?**) in the above display.

When the sweep completes, or is interrupted, the 930A will revert to sending the reference frequency. Softkey 4 will again be labeled "**SWEEP**" as shown below:

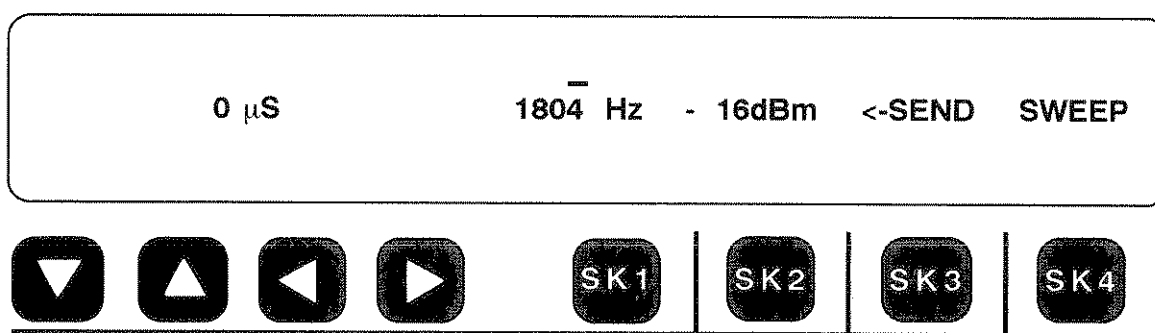

The sweep can be repeated or you can manually set the frequency of the signal to examine the delay at frequencies of interest.

When all of the measurements are complete, the operator at the near, or **SEND**, end can alert the operator at the far end to sweep the return carrier. This will allow a **Forward Reference** measurement to be made of the return path delay. The **SEND** unit transmits the fixed reference signal toward the **REPEAT**, or Slave, unit at the far end.

To examine the level and frequency of the returned carrier, press Softkey 3 (under **<-SEND**). The received level and frequency will be displayed and the label above Softkey 3 will change to read "**<-RECV**". You can toggle between viewing the outgoing signal or the returned carrier at any time. This is especially useful when the far-end is sweeping the returned carrier. An example display of the returned reference carrier while sweeping from the **SEND** unit is shown below:

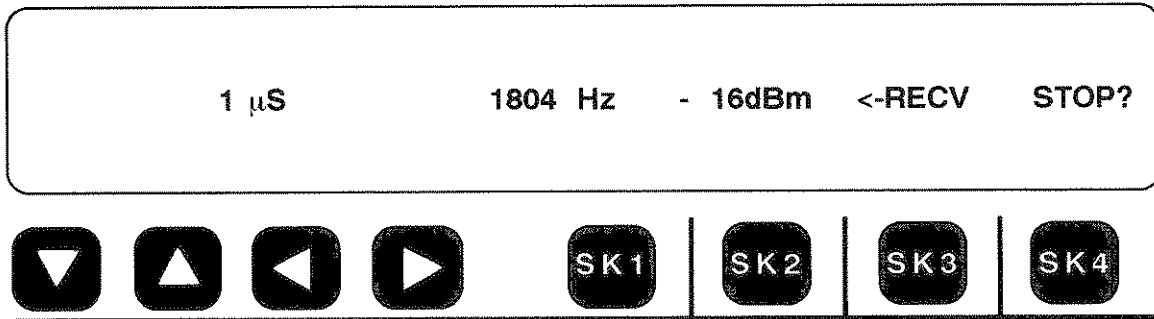

The carrier level should be within the 0 dBm to -40 dBm range and steady for the test to be valid.

5-17.3 EDD MEASUREMENT IN THE REPEAT OR SLAVE MODE

Once the near end 930A has been set up for the **SEND** mode, the 930A at the other end of the circuit must be set to the **REPEAT** mode. The main **EDD** selection display is repeated below:

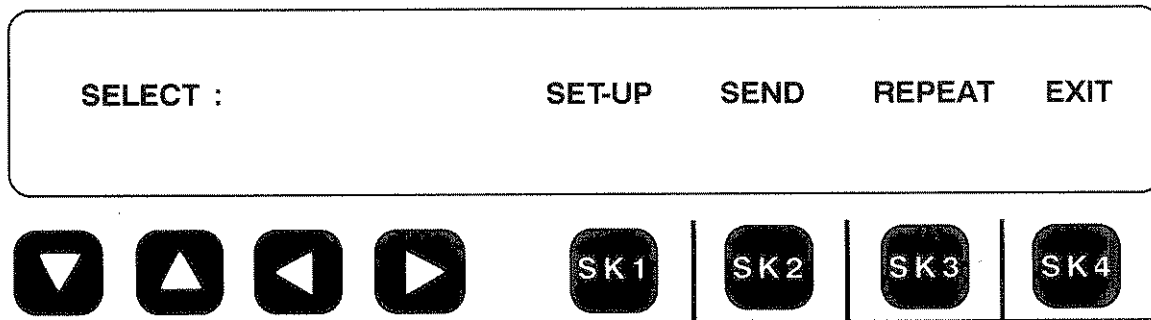

To place a 930A in the **REPEAT**, or Slave mode, press Softkey 3 (under **REPEAT**) and the display on the following page will appear.

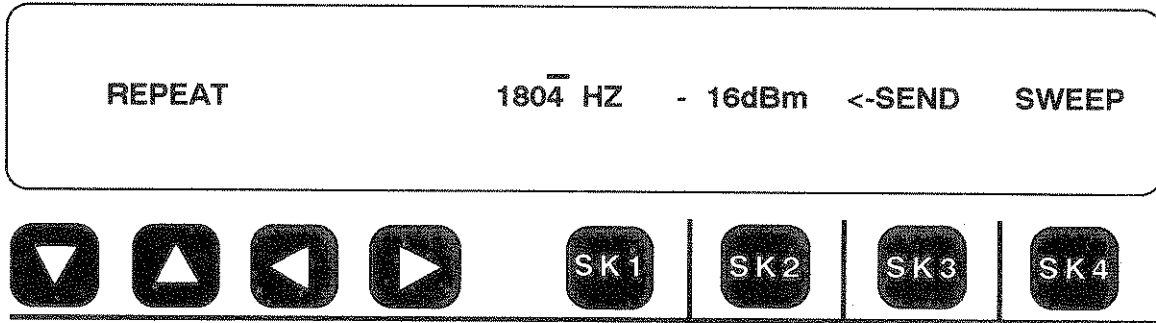

This display shows the level and frequency of the carrier tone that is being used to return the amplitude modulation to the **SEND** unit. The default value is 1804 Hz at -16 dBm.

To change the frequency of the carrier, press Softkey 1 (under the frequency). A highlighted cursor will appear over the last digit of the frequency, as shown above. Use the keypad to enter the new frequency. Press the **ENT** key, or any softkey, to complete the entry. Only frequencies from 304 Hz to 3504 Hz are valid carriers for this test.

To change the level of the carrier, press Softkey 2 (under the level). A highlighted cursor will appear over the last digit of the level, as shown below:

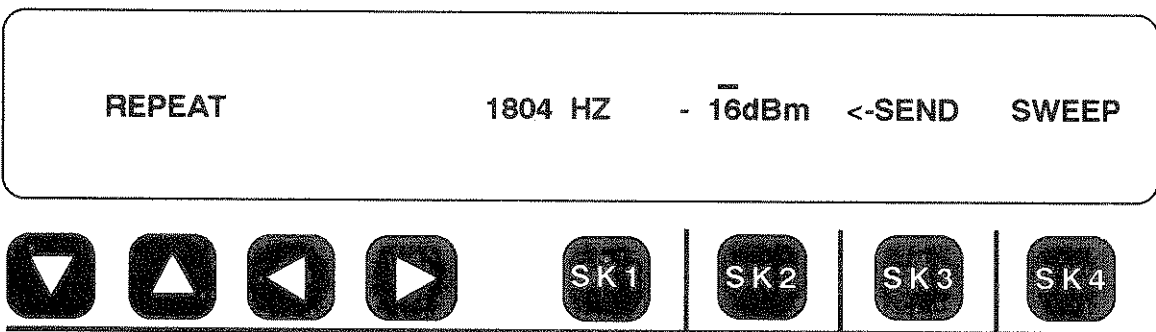

Use the numeric keypad to enter a new level. Press **ENT**, or any softkey, to complete the entry. Only levels from 0 dBm to -40 dBm are valid for this test.

To examine the level and frequency of the signal being received, press Softkey 3 (under <-SEND) and the display will change to that shown on the following page.

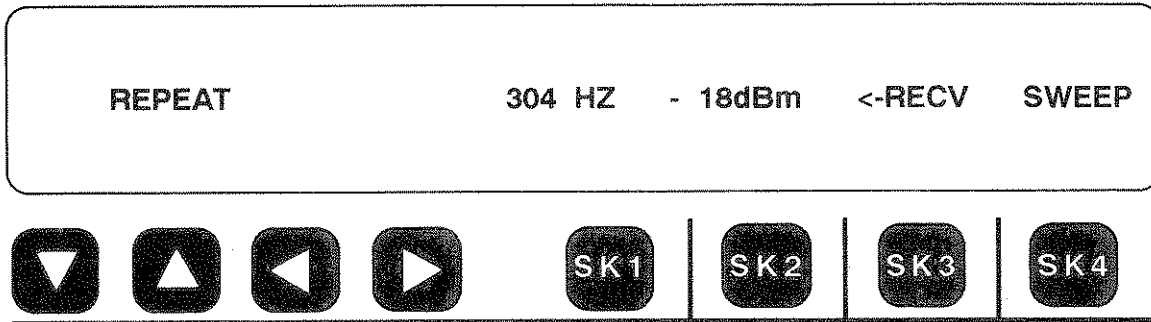

This shows the level and frequency of the signal being sent to the **REPEAT** unit from the **SEND** unit. The level must be between 0 dBm and -40 dBm for the test to be valid. Generally, this display would show a signal of 1804 Hz while the **SEND** end established a reference. This would be followed by a sweep from 304 Hz to 3204 Hz. When the sweep completes, the **Return Reference** part of the measurement is over. Then it is the turn of the **REPEAT** unit to sweep for the **Forward Reference** test. You can toggle between the received signal and the returned carrier by pressing Softkey 3 (under **<-SEND** or **<-RECV**).

To sweep the returned carrier for a **Forward Reference measurement**, press Softkey 4 (under **SWEEP**) and the 930A display will change to:

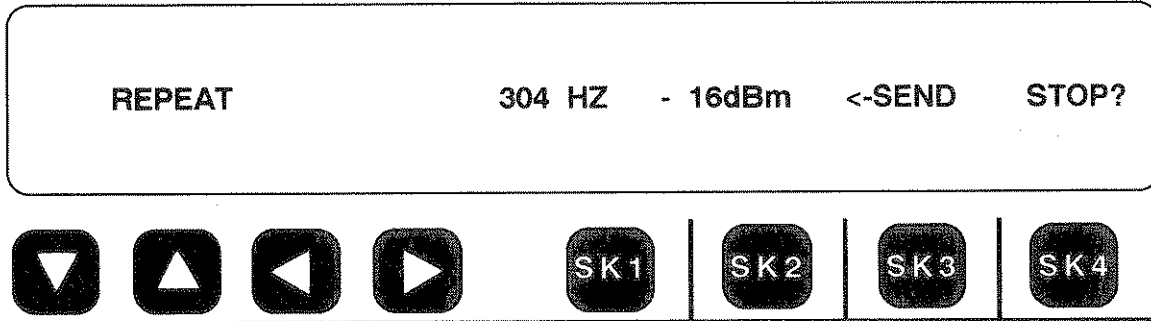

The 930A will begin to sweep the returned carrier through the frequencies that were selected previously. To interrupt the sweep, without leaving the **REPEAT** mode, press Softkey 4 (now under **STOP?**). When the sweep completes, or is interrupted, the 930A will revert to sending the reference frequency. Softkey 4 will once again be labeled "**SWEEP**".

Press the **OPTION MENU** key when testing is complete and the 930A will return to the main **EDD** selection display. You can **exit** by pressing Softkey 4 (under **EXIT**).



5-18 PEAK TO AVERAGE RATIO (P/AR) (MENU OPTION 18)

With Option 930A-06 installed in your 930A, you can measure **P/AR** values over a 0 to 120 P/AR unit range.

You connect the 930A to the circuit under test at the 2- or 4-wire analog trunk access point, or **DEMARC**. **It can also be used on a T-1 PCM Trunk** at the **DSX** with Option 930A-08E or -09E. **Before making a P/AR test**, set the 930A Trunk Type to the correct settings.

To begin making P/AR measurements, perform the following steps:

Press the OPTION MENU  Option Menu function key.

Use the UP/DOWN   arrow keys to select Menu Option 18: P/AR MEASUREMENT.

The Model 930A display will appear as shown below:

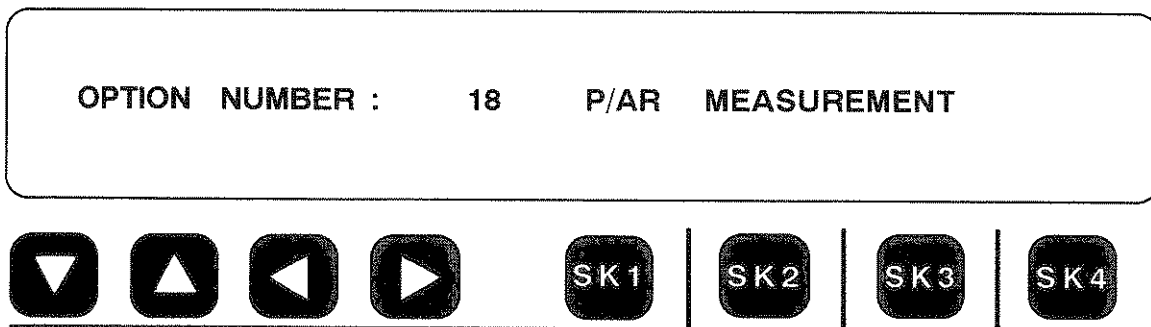

Press any softkey under the display to get into the main menu:

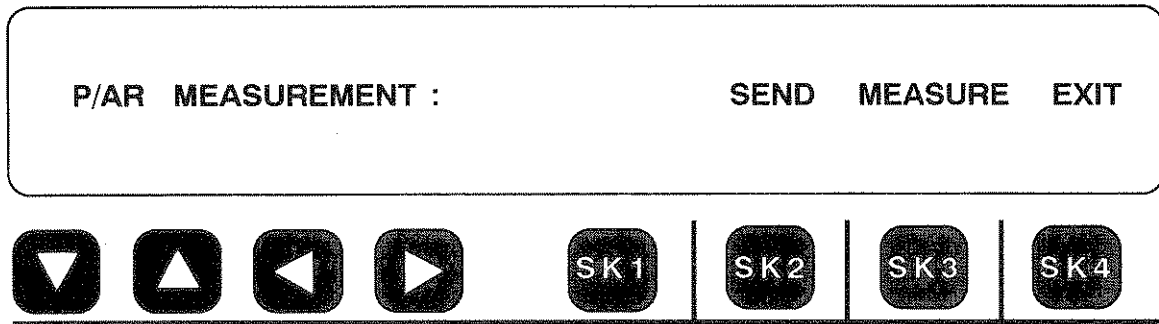

Softkey 2 (SEND) controls the set-up of the **P/AR** transmitter level and also sends the **P/AR** signal on 2- and 4-wire circuits. **The set-ups are retained** in non-volatile memory and need not be accessed every time a measurement is made, unless the level is to be changed.

Pressing Softkey 2 (SEND) brings up the **P/AR** transmit level display. The default **SEND** display is shown below:

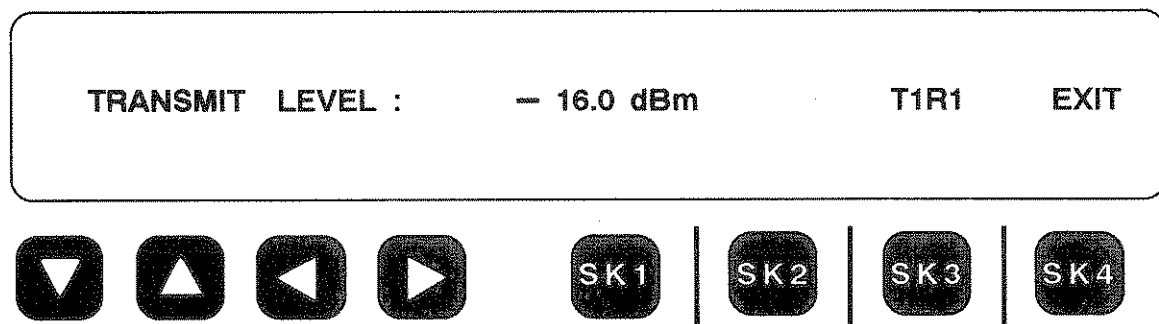

The test set at the far end of the circuit would receive and display the **P/AR** measurement. Normally, transmit levels are kept below -13 dBm, relative to the 0dB TLP, to prevent adjacent channel interference. **Select the desired level** using the numeric keypad and complete the data entry by pressing the **ENTER** key. **Pressing Softkey 4 (under EXIT)** in the above display returns the 930A to the main **P/AR** display.

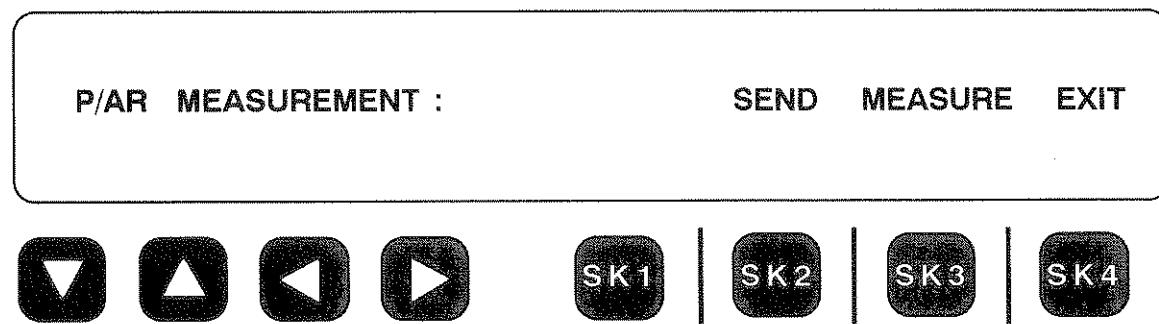

Once the **P/AR** transmitter has been turned on and the level has been set, you can begin **sending and receiving** the **P/AR** waveform on a 4-wire circuit, or **receiving P/AR** on a 2-wire circuit, by pressing **Softkey 3 (MEASURE)** in the above display. Pressing Softkey 3 brings up the **P/AR** measurement display. A **P/AR** measurement display is shown below:

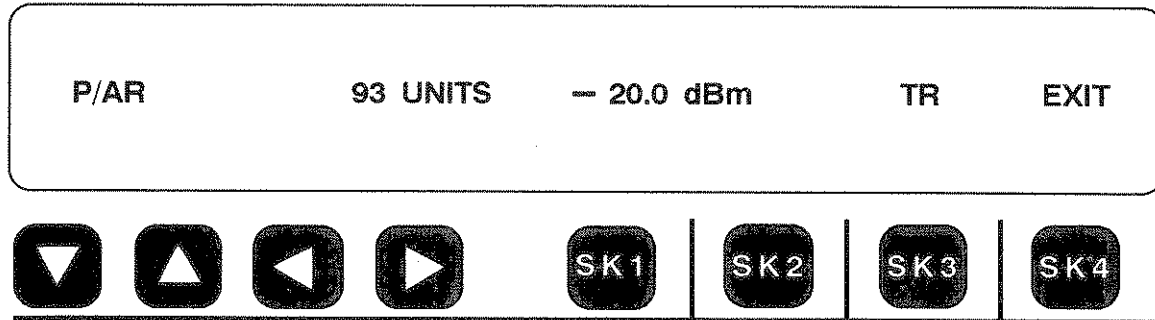

It is important to note that **P/AR** measurements are end-to-end measurements. **On 2-wire circuits**, one end transmits while the other receives, and then the sender and receiver switch places. **When measuring P/AR on 2-wire circuits**, one of the test sets must have its transmitter turned off and act as a receiver only. To accomplish this, press Softkey 3 under **MEASURE** immediately after entering the **P/AR** menu option. **Do not** press Softkey 2 under **SEND**. This keeps the **P/AR** transmitter turned off.

On 4-wire circuits, simultaneous transmitting and receiving is possible. When entering the **P/AR** option menu, press Softkey 2 under **SEND** first. Then after checking or adjusting the transmit level, press Softkey 4 to **EXIT** and then press Softkey 3 under **MEASURE**. The **MEASURE** mode does not disable the transmitter so you are now transmitting and receiving at the same time.

5-19 INTERMODULATION DISTORTION (MENU OPTION 19)

Intermodulation Distortion (IMD) measures the second- and third-order distortion products created in a non-linear circuit in the presence of a four tone signal.*

Intermodulation Distortion, sometimes referred to as Non-Linear Distortion, or 4-Tone Intermod, is an end-to-end measurement. That is, one test set sends the tone pairs at 857 Hz, 863 Hz and 1372 Hz, 1388 Hz while the other set has it's receiver looking at a band of frequencies centered around 520 Hz, 2240 Hz and 1900 Hz. The energy received in these filters constitutes the energy in the second- and third-order **IMD** products. **On 4-wire circuits**, a loopback can be inserted at the distant end so that one set may send and receive. On a 2-wire circuit, two sets are required, with one set either sending, or receiving, in turn.

Before testing, the user must select the appropriate Trunk Type. Connect the 930A to the circuit. Once this has been accomplished, perform the following steps to place the 930A in the Intermodulation Distortion measurement mode:

Press the Option Menu  Option Menu key.

Use the UP/DOWN   arrow keys

to select Menu Option 19: INTERMOD DISTORTION.

* Licensed under HLI Patent No. 3,862,380

The Model 930A display will appear as shown below:

OPTION NUMBER : 19 INTERMOD DISTORTION



Press any softkey under the display to enter the Menu Option:

4-TONE INTERMOD: SEND MEASURE EXIT



Press Softkey 2 (under **SEND**) to transmit and/or adjust the **IMD** tones being sent, to select the signal-to-noise test tones, or to send the Intermod tones over a two-wire circuit. Press Softkey 2 to bring up the display:

SEND: SIG/NOISE 4-TONE -13 dBm EXIT



The cursor appears over the last test selected. To send the signal-to-noise test tones, press Softkey 1 (under **SIG/NOISE**). This will suppress one tone pair while amplifying the other pair to maintain the same average level. This measurement is usually performed before **IMD** testing since the test set uses the **S/N** value to automatically correct the **IMD** measurement results.

A Signal-to-Noise measurement display example is shown below:

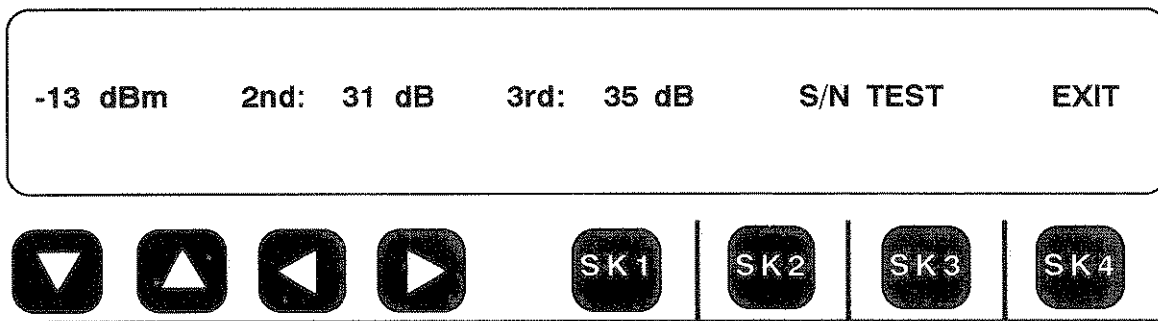

The **S/N** values for the low and high tone pairs occupy the 2nd and 3rd order distortion positions.

Returning to the main **SEND** display:

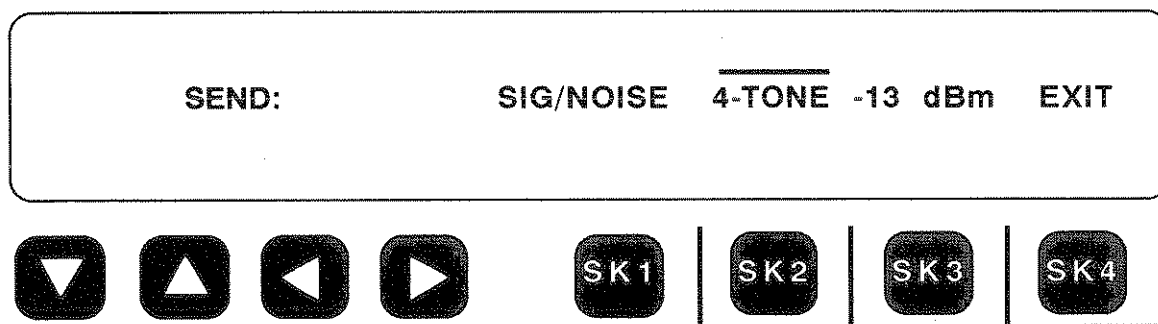

Press Softkey 2 (under **4-TONE**) to send the four intermodulation distortion test tones at the level displayed. On a two-wire circuit, another 930A, or a test set with Intermod Distortion measuring capability, must be at the distant end.

If a transmit level other than the default value of -13 dBm is desired, simply enter the new value using the numeric keypad. Press the **ENT**(Enter) key after the new level has been keyed in. The range of permissible values for the send levels vary with Trunk Type selected. These values are:

Analog: -40 dBm to +0 dBm
 PCM: -40 dBm to -6 dBm

The Model 930A will prevent entry of levels outside those specified above.

Press Softkey 4 to **EXIT** to the main **IMD** menu. This will not interrupt the tones being sent. From the main menu, the test can be terminated, or the **MEASURE** mode can be selected to test on a 4-wire looped-back circuit.

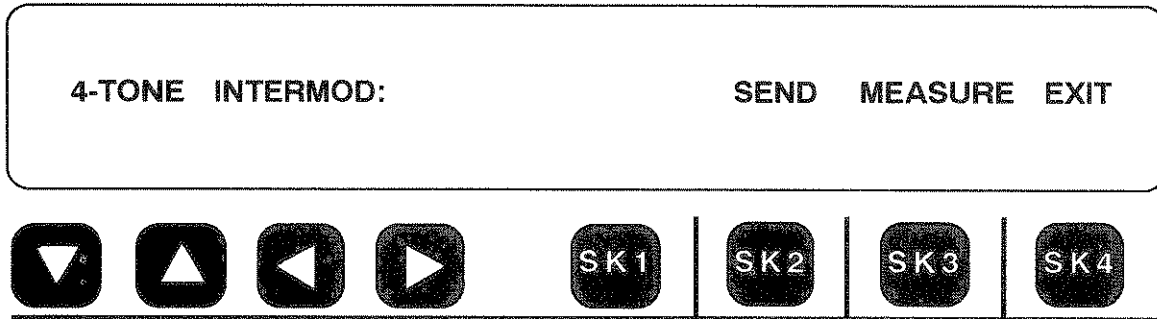

Pressing Softkey 4 (under **EXIT**) will terminate testing. Pressing Softkey 3 (under **MEASURE**) measures the Intermodulation Distortion present on the trunk under test. This will not disable the tones being sent under the **SEND** sub-menu unless a 2-wire trunk type has been selected.

Pressing Softkey 3 (under **MEASURE**) will bring up the **IMD** measurement display. A typical display is shown below:

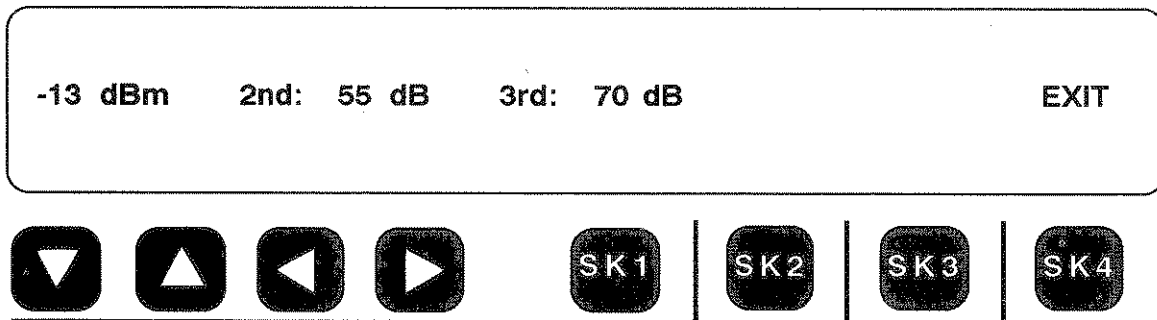

The first field in the above display (labeled **-13 dBm**) shows the composite received level of the four **IMD** tones in this example. If no signal is present this field will be blank. The second field (labeled "**2nd: dB**") is the level at which the second-order IM products are being received below the level of the four **IMD** tones. In this example, the second-order products are 55 dB below the **IMD** tone level of -13 dBm for a total of -68 dBm. Similarly, the third field (labeled "**3rd: dB**") is the level at which the third-order IM products are being received below the -13 dBm signal level.

The gap between the third field and the word "**EXIT**" is reserved for messages.

These messages are:

1. The message "**INVALID**" indicates an invalid signal; i.e., the **IMD** signal is absent, the level is below -40 dBm, or too high for the circuit (>0 dBm in analog, >-6 dBm in PCM). A typical display is shown below:

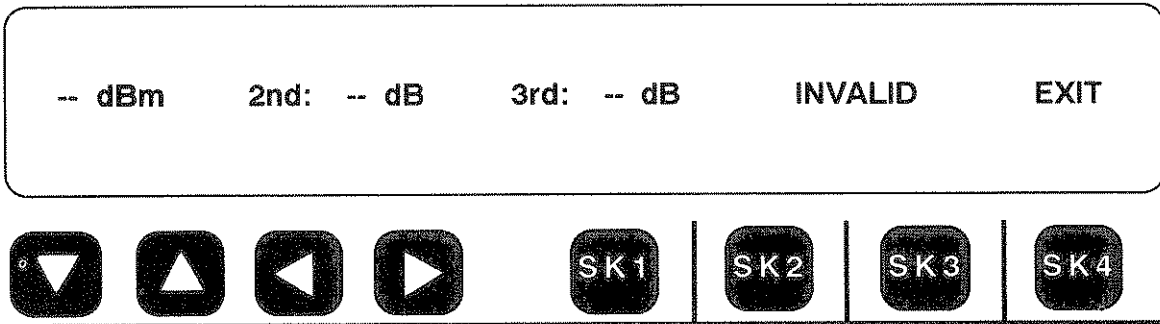

2. The message "**TWIST**" indicates that the **IMD** tones are being received at unequal levels (i.e., they differ by more than 6 dB from each other). A sample display is:

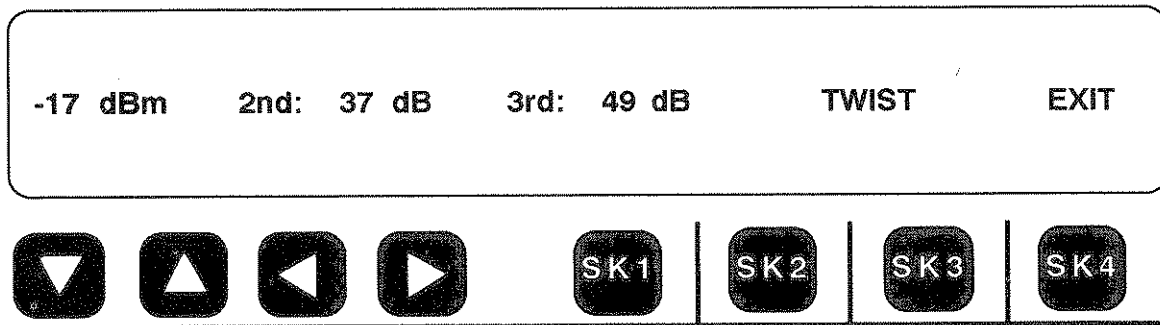

3. The message "**SPURIOUS**" indicates the presence of a spurious tone (any tone other than the four test tones). A typical display follows:

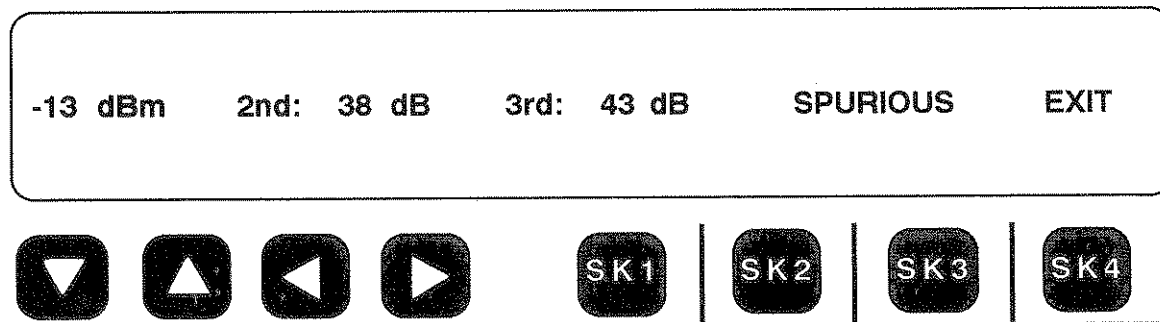

4. The message "S/N TEST" shows that the 930A is receiving the signal-to-noise test tones. The fields labeled "2nd: dB" and "3rd: dB" now contain noise measurements where the distortion products used to be. The measurements are in dB below the received signal as a S/N ratio. The display will appear as:

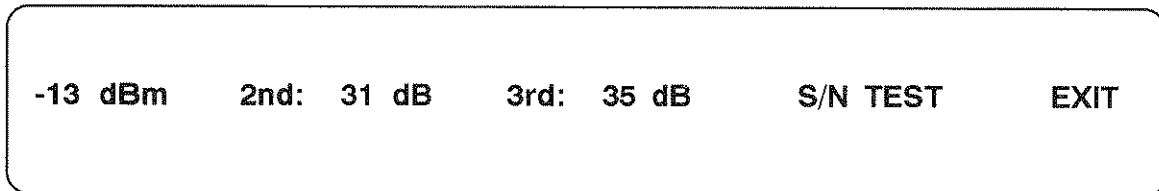

5. The message "ADJUSTED" indicates that the distortion measurements are being corrected automatically for signal-to-noise ratio. A typical display is:

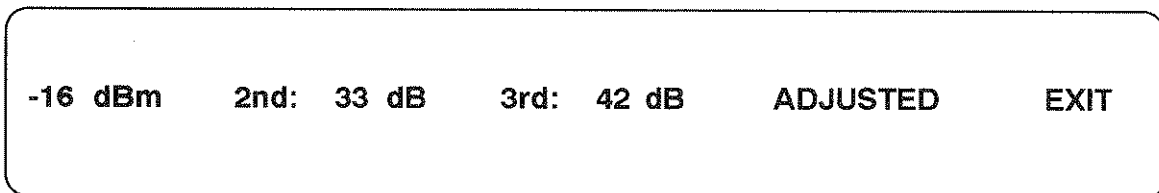

The following example of a corrected **IMD** test performed on a 4-wire circuit will serve to clarify the procedure.

5-19.1 MAKING A 4-TONE IMD TEST ON A FOUR-WIRE CIRCUIT

The trunk to be tested is a 4-wire circuit. It is also assumed that there is Network Channel Terminating Equipment (NCTE) at the far end which is capable of providing a loopback on the line. A typical circuit diagram is shown below:

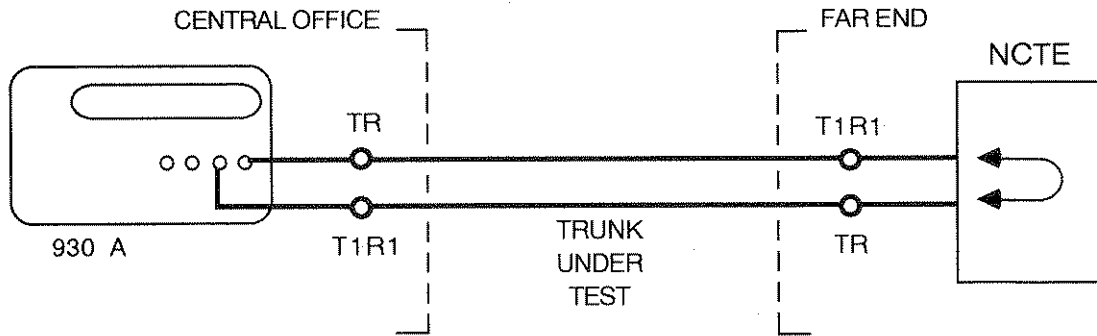

To make a corrected measurement of Intermodulation Distortion:

1. Select the correct Trunk Type on the 930A and connect the test cords.
2. If the trunk under test is a dedicated line, and not a dial-up line, proceed to step 3. If not, press the **DIAL/RING** key, go **Off Hook**, and dial the far end loopback device's number.
3. Press the **SEND TONE** key and set the 930A to send 2713 Hz at -10 dBm for 5 seconds to loop the device at the far end.
4. Press the **MEASURE TONE** key. When the line is looped, the 2713 Hz tone will be displayed and the tone will be audible.
5. Press the **SEND TONE** key again and press Softkey 4 to turn off the 2713 Hz tone.
6. Press the **OPTION MENU** key. Enter the numbers **1** and **9**. Press the **ENT** (Enter) key. The 930A display will become:

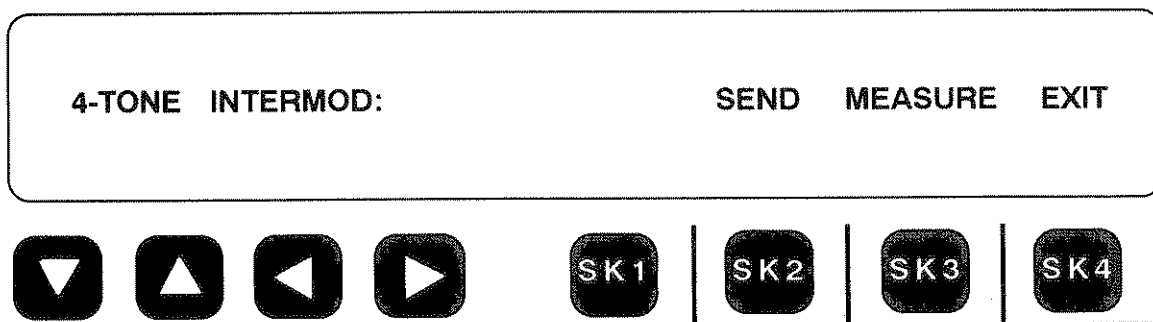

7. Press Softkey 2 (under **SEND**). The 930A display will change to:

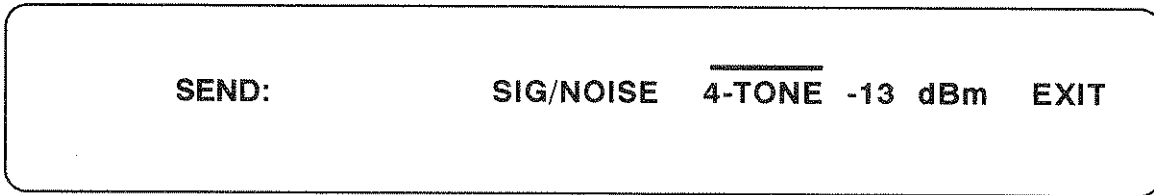

8. Press Softkey 1 (under **SIG/NOISE**), and set the level to -13 dBm if it is not at that level. Press Softkey 4 to **EXIT** to the main menu. The 930A sends the Signal-to-Noise test tones.
9. Press Softkey 3 to select **MEASURE**. Wait for a few seconds for the measurements to stabilize. The received level and the fields labeled "2nd: dB" and "3rd: dB" will contain test results. A typical display will be:

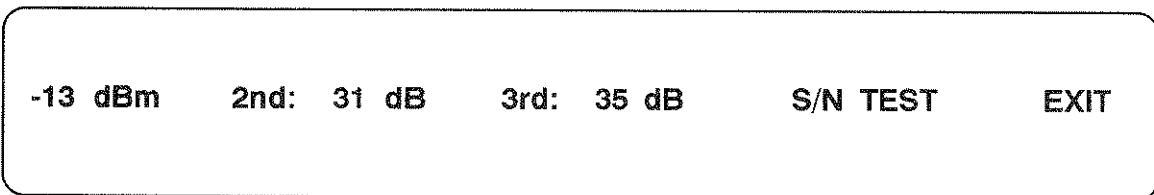

10. Press Softkey 4 to exit back to the main menu.

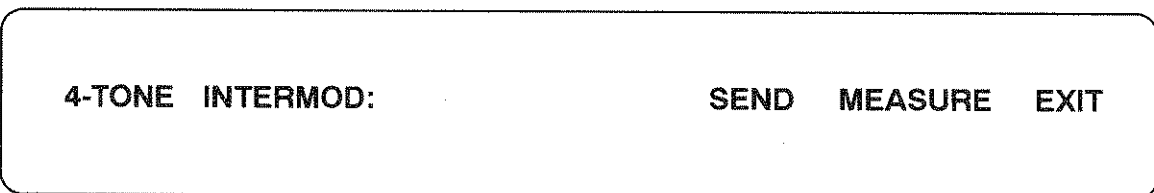

11. Press Softkey 2 to select **SEND**.

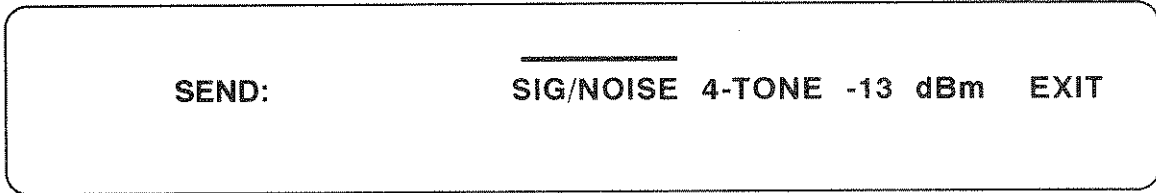

12. Press Softkey 2 (under **4-TONE**) and the 930A sends the **IMD** test tones at -13 dBm. Press Softkey 4 to exit back to the main menu.



13. Press Softkey 3 (under **MEASURE**). Wait for a few seconds for the measurement to stabilize. The word "**ADJUSTED**" should appear to the left of the word "**EXIT**". An example of a corrected Intermodulation Distortion products display is shown on the following page.

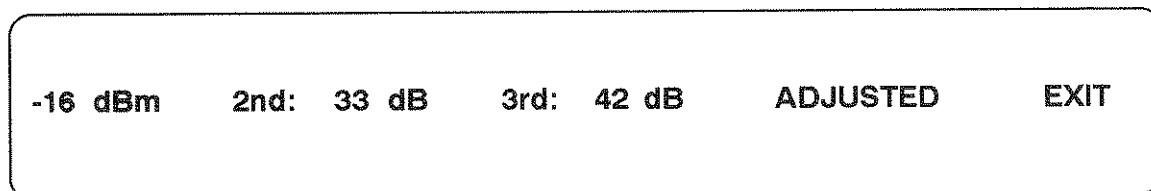

14. Before going back On-Hook, press the **SEND TONE** key and send the 2713 Hz tone again to release the loopback. When this has been accomplished, place the 930A On-Hook, or **EXIT** from the Menu Option, to terminate testing.

This page intentionally left blank.





5-20 TO CHECK A/B/C/D BIT STATES ON ALL 24 CHANNELS (MENU OPTION 20)

When you are working on a T-1 span, it is sometimes very useful to be able to see the state of the A and B bits (also C and D bits on ESF) on all 24 channels simultaneously. With the 930A, you can see these bits at the DSX monitor jacks, and you can check them in one direction (Option 930A-08E), or in both directions (Option 930A-09E).

To look at the supervision states, all you have to do is connect your 930A to the DSX. Make sure the 930A is set to the PCM Trunk Type and that default settings are correct. If it is set to the **MON-1** mode, you will be able to look at the supervision bits on one side at a time. If you are in the **MON-1&2** mode, you can switch from **RECV-1** to **RECV-2**, and look at the supervision bits in both directions. When the 930A is set-up, do the following:

Press the OPTION MENU  **Option Menu** function key.

Use the UP/DOWN   arrow keys to get to **Menu Option 20: 24 BIT DISPLAY.**

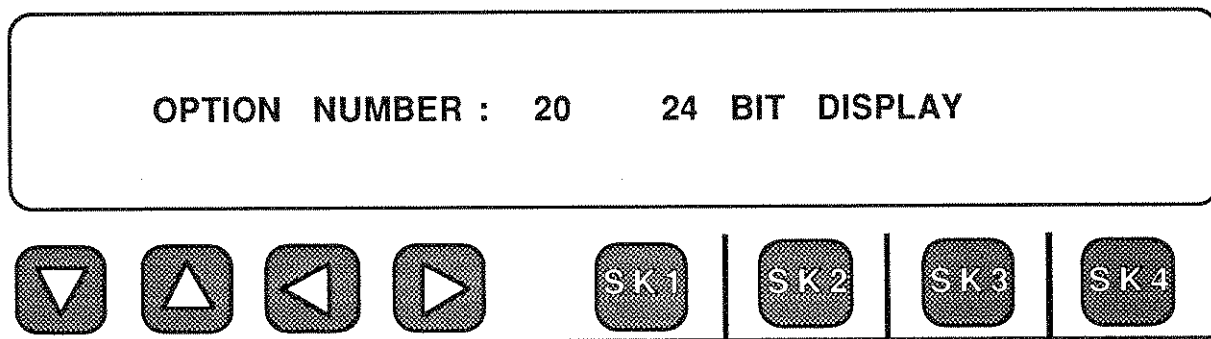

Press any softkey under the display and the A bit display will come up. An example appears below:

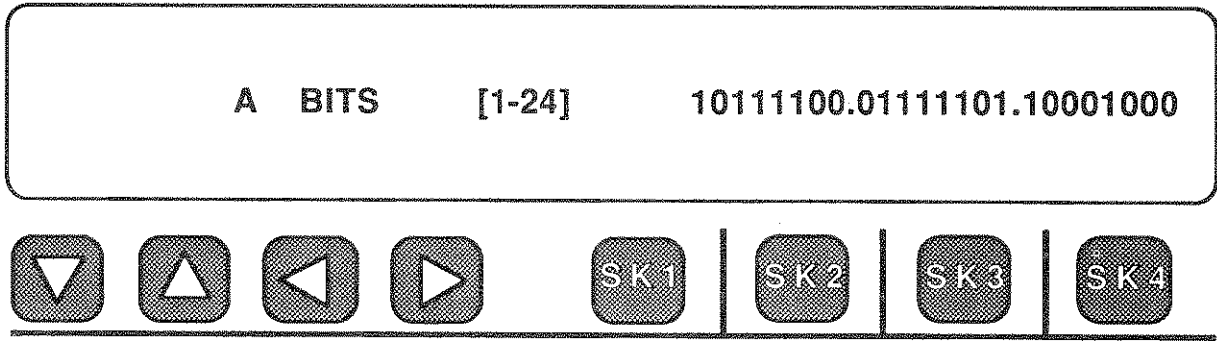



The channels are numbered from 1 to 24, left to right. The bits have two states, 0 and 1. Usually a 0 indicates On Hook and a 1 indicates Off Hook or busy. On a working span, you will see calls completing and terminating, so the display will be changing constantly as calls come and go. Pressing any softkey or arrow key will page you through the B bit display. On an Extended Superframe span, you will also get the C and D bit displays.

If you are in **PRINTER** Remote mode, the 930A will print a copy of its' display whenever a bit changes. In **COMPUTER** remote, it will send a Bell (ASCII 07) to the computer.

5-21 TO MANUALLY TOGGLE THE A/B/C/D BITS OR VIEW BOTH DIRECTIONS SIMULTANEOUSLY (MENU OPTION 21)

Normally, you go ON and OFF HOOK by using the front panel Hook Switch. The 930A also provides you with Menu Option 21 which gives you complete control over the A/B/C/D bit states. This Menu Option also lets you view the A/B/C/D bit status on the selected channel in both directions when you are in the MON-1&2 mode. You can set the states of your supervision bits manually from Menu Option 21: TOGGLE A\B BITS.

Press the OPTION MENU  Option Menu function key.

Use the UP/DOWN   arrow keys to get to Menu Option 21: TOGGLE A\B BITS.

Once you get to this menu, the front panel Hook Switch is disabled, and control of the ON and OFF HOOK states lies with this Menu Option.

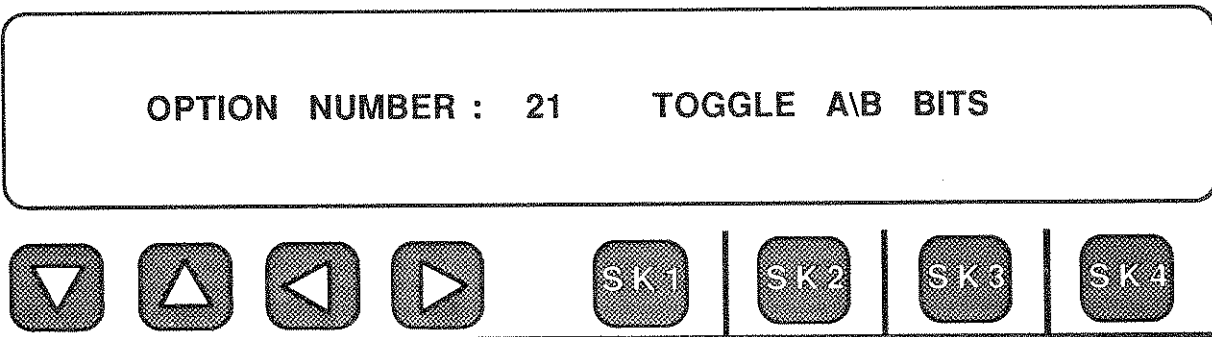

Press any softkey under the display, and depending upon whether you are on a D4 Superframe, SLC 96 or Extended Superframe T-1 span, the display will be:

For normal D4 Superframe:

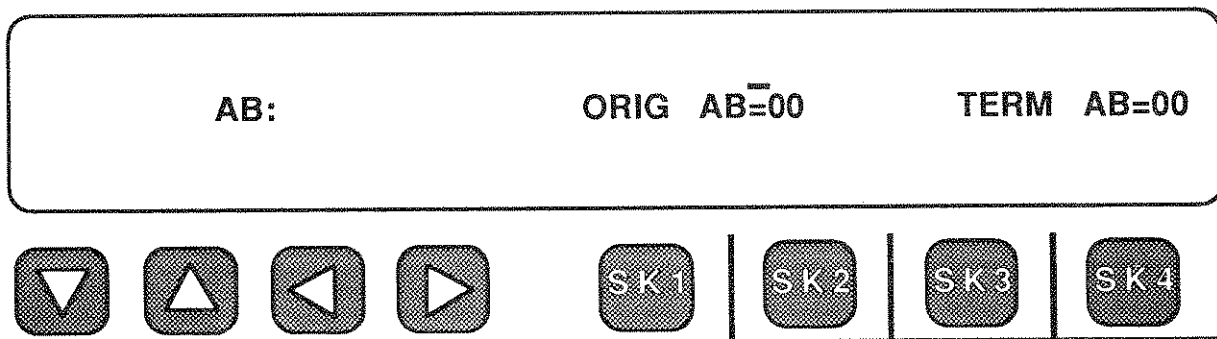

For normal SLC96:

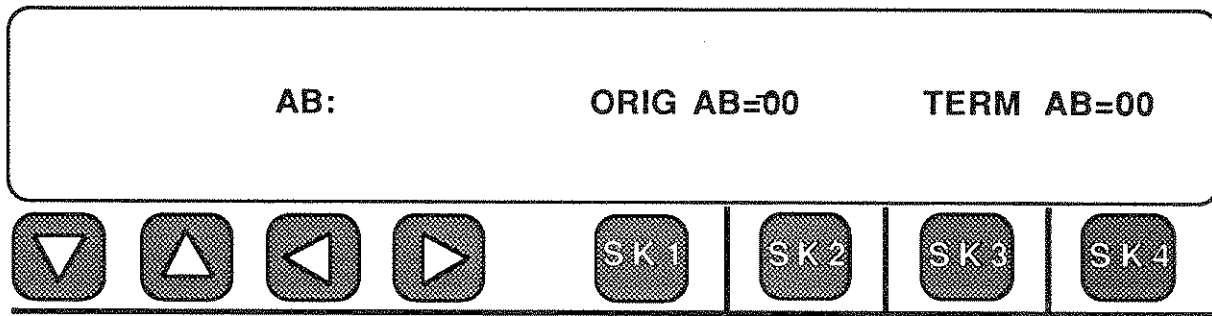

For Extended Superframe:

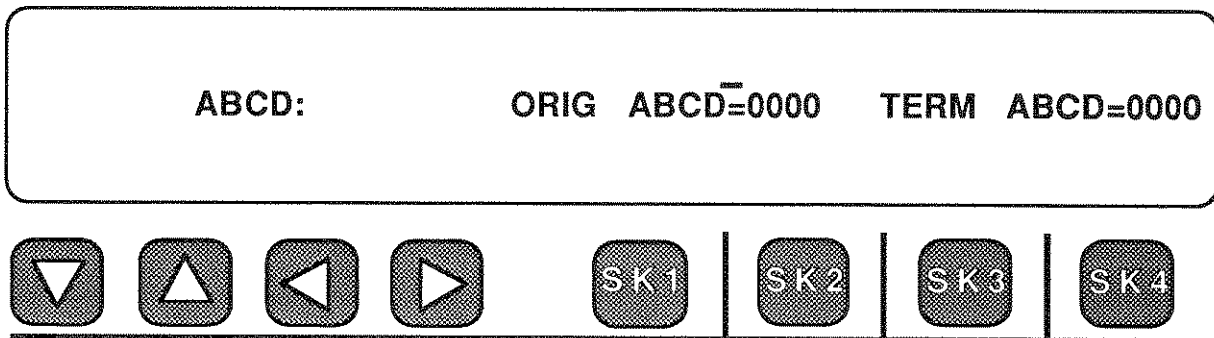

In all of these examples, the originating end is **ON HOOK** since the states of the bits are all 0.

Note that the cursor is flashing over the first digit (the A bit) in both cases.

To change the state of the A bit to a 1, press 1 on the keypad and the A bit will be changed. The cursor will then move over the next digit.

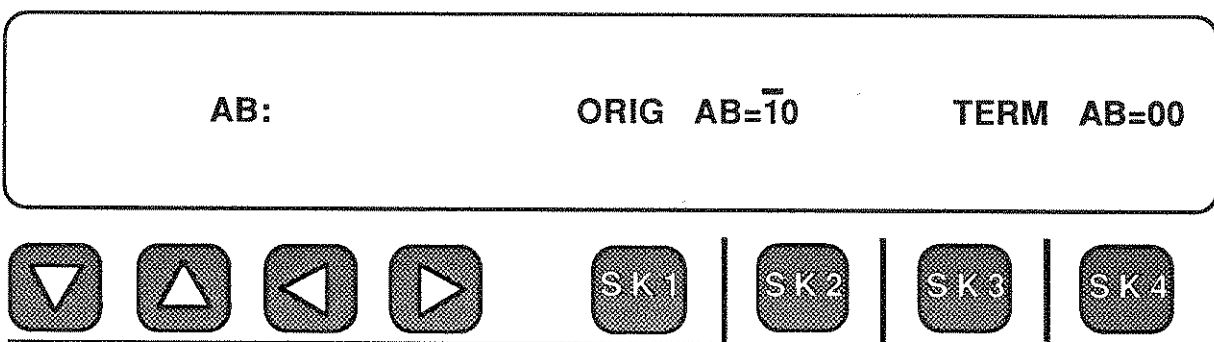

You could scroll down the line and change all the bits to a 1 state. In **ESF** this would look like:

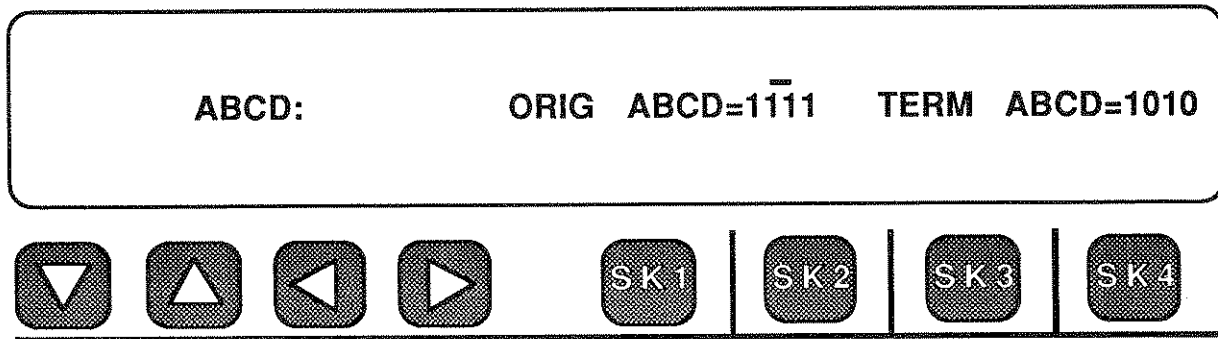

The **TERM** side shows the state of the supervision being returned from the far end of the circuit. In the above example you see that the B and D bits never went high.

The **TERM** bits come from the **PCM IN** jack in the **RECV** direction (**PCM IN 1** for **RECV-1**). In **TERMINATE** or **MON-1** modes, the **ORIG** bits come from the 930A. In **MON-1&2** or **D&I** modes, the **ORIG** bits come from the other direction. In all cases, **TERM** is the **RECV** bit stream and **ORIG** is the other.

5-22 ABSOLUTE DELAY (930A-21)

5-22.1 INTRODUCTION

Absolute Delay is now available on the 930A. This capability provides a Round Trip delay measurement in Milliseconds of the total delay for a given circuit. Some major differences between Absolute Delay and Envelope Delay are the following:

1. Forward frequency for Absolute Delay will be 1020 Hz.
2. Return frequency for both is 1804 Hz.
3. The Modulation frequency for both is 83.333 Hz.
4. The level of the signal is measured for Absolute delay.
5. Absolute Delay may also require a Echo Canceller Disable tone of 2100 Hz.
6. The Absolute Delay measurements are displayed to 1 millisecond resolution.

5-22.2 SETUP PROCEDURE

To setup Absolute Delay, do the following:

Select **OPTION MENU 22**. Press Enter or the first Softkey. The initial screen is:

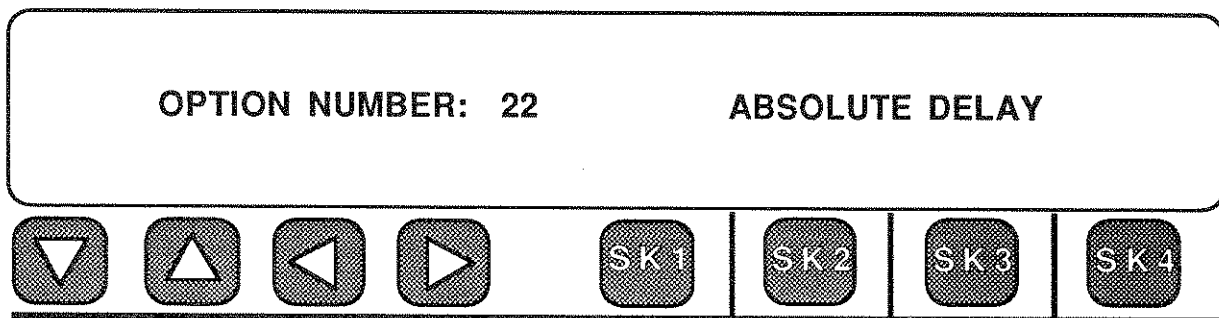

Press any key:

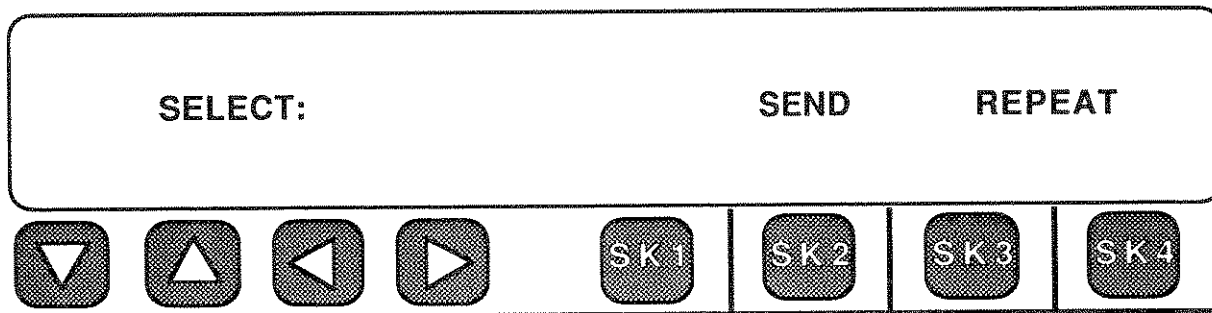

To select **REPEAT** Mode, Press (SK3). This places the 930A in a Slave/Remote mode that repeats the signal back to the other end (Forward) 930A.

Note: Early versions of this feature are designed to work only into a loopback at the far-end, thus eliminating the need for a **REPEAT** feature.

To make an Absolute Delay measurement, proceed as follows:

For early versions, make sure a 4-Wire loopback is in effect at the far-end. Press **SEND** (SK2) and verify the measurement: See display below:

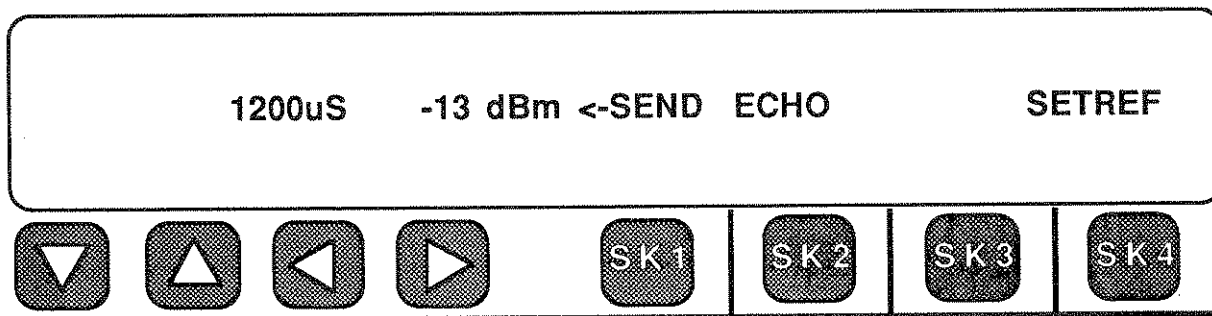

The initial measurement is normally in microseconds and is considered preliminary. If the Echo Canceller must be disabled, Press **ECHO** (SK2) to send 2100 Hz disabling tone.

The following screen is displayed:

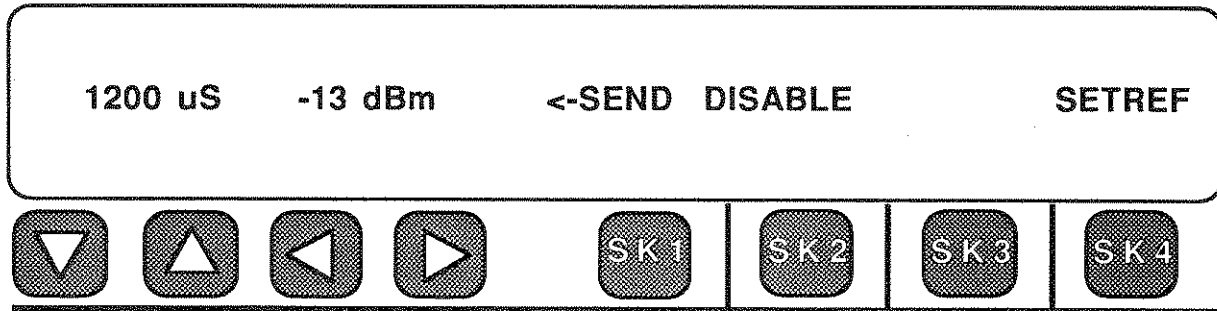

Disabling tone is typically sent for a minimum of 2700. Normal Absolute Delay signal must be resumed within 75 Milliseconds of the end of Disable tone.

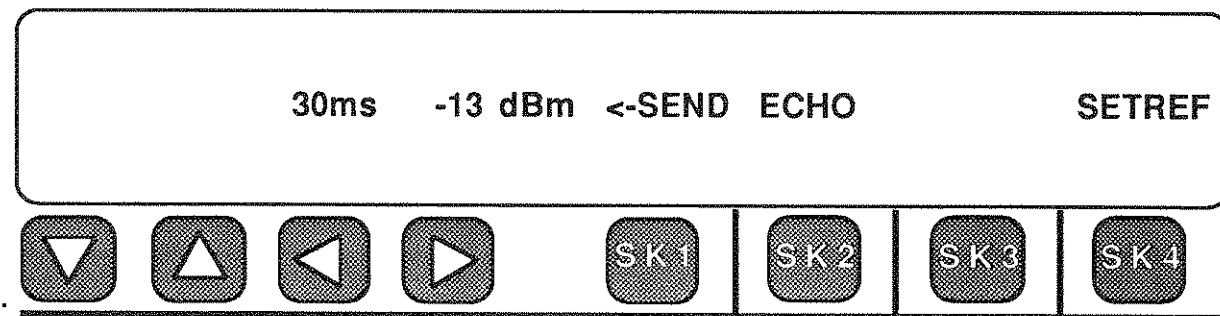

Wait for the measurement to settle. Record the reading. Press **SETREF** (SK4). Again, wait for the measurement to settle and record the second reading. The second reading is typically the most accurate measurement. It would be logical to make a few additional measurements and verify that these measurements continue to be the same. This test is now complete.

The current version of Absolute Delay will allow you to select **REPEAT** mode. When this is done, the 930A will go into the **REPEAT** mode.

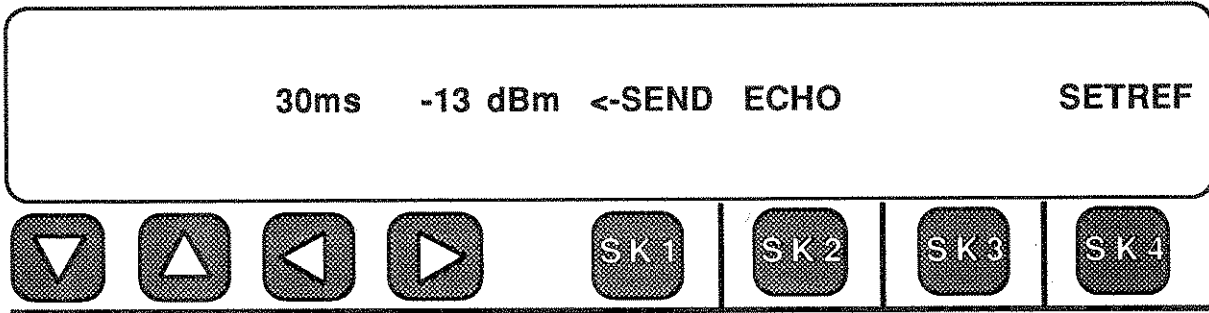



Take a second measurement as above. Record the second reading as the true measurement.

5-25 USING THE 930A AS A TYPE 105 FAR END RESPONDER (MENU OPTION 25)

With Option 930A-12, you can configure the 930A as a Type 105 Far End Responder. The 930A can then be controlled by any CAROT compatible ROTL. You can measure Loss, Noise, Noise with Tone, Gain/Slope, and Return Loss. The 930A can be accessed over any of it's analog interfaces, or it can provide this function directly on a T-1 PCM channel.

Before testing, set up the **Trunk Type**. Connect the 930A to the circuit. Once this has been accomplished, perform the following steps to place the 930A in Far End Responder mode:

- Press the Option Menu  Option Menu key.
- Use the UP/DOWN   arrow keys to select Menu Option 25: FAR END RESPONDER.

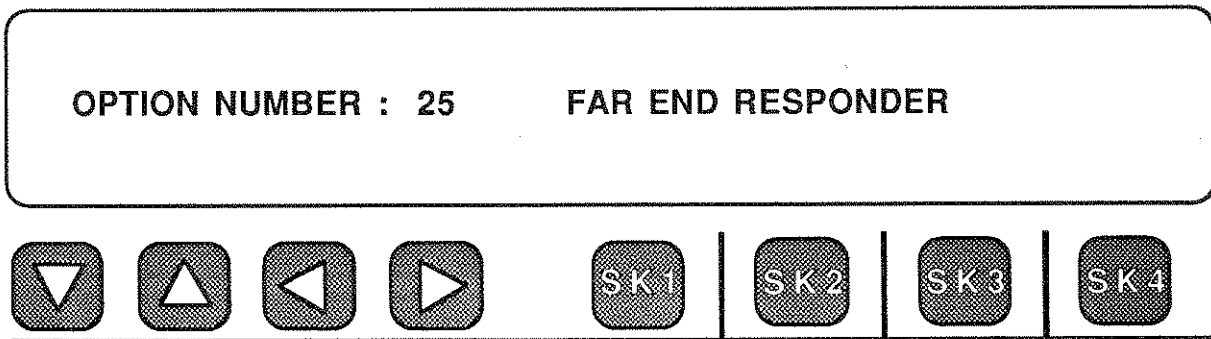

To change the **SEND TLP**, press Softkey 1 and then enter the desired TLP using the keypad. Press ENTER to complete the selection. To change the **RECEIVE TLP**, press Softkey 3 and enter the desired TLP from the keypad. Press ENTER to complete the selection. When you have finished, press Softkey 4 to EXIT and the display changes to:

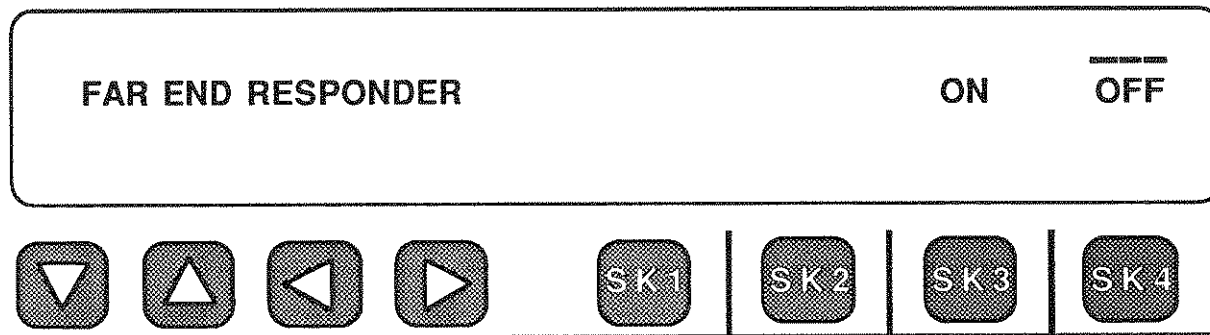

You turn on the **far end responder** by pressing **Softkey 3**. A cursor will appear over the **ON** indication. The 930A is now acting as a Type 105 Responder waiting to be accessed. The above display appears regardless of whether or not you choose the manual sequence. In either case, pressing Softkey 3 is necessary to enable the responder function.

When accessed by ringing, or far-end seizure, the 930A goes off hook and responds with a 2225 Hz test progress tone (**TPT**). The 930A then waits for **MF** commands and performs the corresponding Type 105 tests. The 930A will continue in this mode until:

- a. It is released by the calling party via an MF "release" command.
- b. The calling party goes **"On Hook"** (See Note).
- c. No **MF** command is received for 20 seconds (930A defaults to Manual mode if selected).
- d. The operator presses the **"OFF"** softkey, or any Function key on the 930A front panel.

When the 930A is released, or the calling party goes **On Hook**, the 930A goes On Hook for 1 second and then awaits seizure or ringing. If the 930A is allowed to time out (20 seconds without an **MF** command), it will either go **On Hook**, or initiate the manual test sequence (if selected).

NOTE: If the 930A is on a **LOOP** trunk, simulating the subscriber (providing **CONTACT** rather than **BATTERY**), it will expect the far end to remain **On-**

Hook, and will not treat this as a release condition.

For **PBX** testing, the manual mode sequence is most useful. If the Manual mode has been selected, the responder is allowed to time out (no **MF** command is sent) for 20 seconds or more. The Model 930A then provides the manual trunk test tone sequence shown below:

1. 9 seconds of 1004 Hz tone at -16 dBm0
2. 1 second of quiet termination
3. 9 seconds of 404 Hz tone at -16 dBm0
4. 1 second of quiet termination
5. 9 seconds of 2804 Hz tone at -16 dBm0
6. 30 seconds of quiet termination
7. Short burst of TPT (2225 Hz) signaling end of sequence
8. On-hook

If the manual test sequence is not enabled, the 930A will return to the **On Hook** state after a 20 second time out.

NOTE: To initiate manual testing, you must enable the Manual Sequence when the 930A display asks for the choice. That display is repeated below and shows **OFF** as the previous condition.

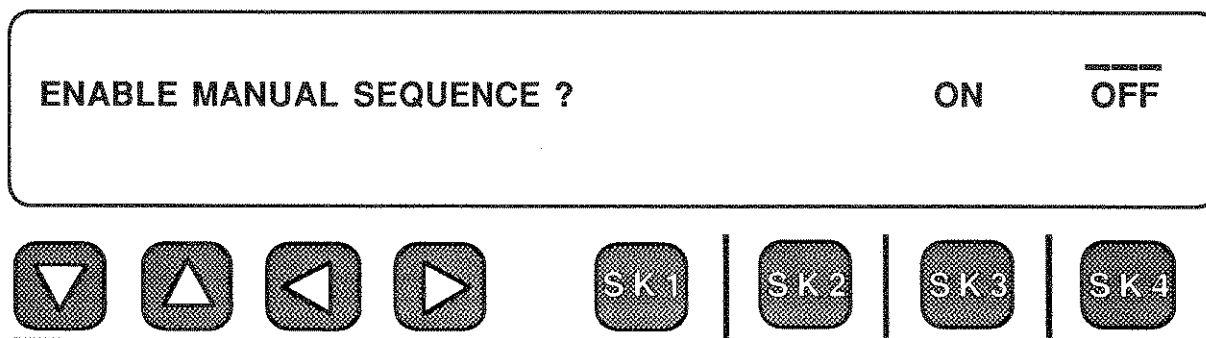

Press **Softkey 3** to enable the Manual Sequence. Press **Softkey 4** if you do not want it.

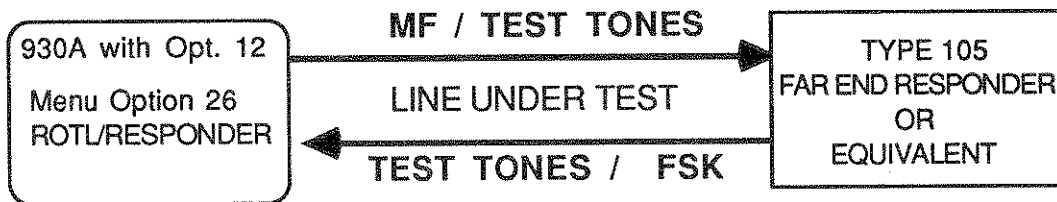

**5-26 USING THE 930A AS A ROTL/NEAR-END RESPONDER
(MENU OPTION 26)**

With Option 930A-12, the Model 930A can also perform the functions of a **ROTL/Near-End Responder**. The 930A can access a 105 far-end responder and supply the MF signaling necessary to initiate Loss, Gain/Slope, C-message Noise, Noise with Tone, and Return Loss measurements. A typical connection is shown below:



The 930A can also access a SAGE Model 356E Far End Responder or another 930A and do the extended range of tests listed on page 4-77.

To set the Model 930A up as a ROTL/Near-End Responder, do the following:

- Press the Option Menu  Option Menu key.
- Use the UP/DOWN   arrow keys to select Menu Option 26: ROTL/RESPONDER.

The 930A display will appear as:

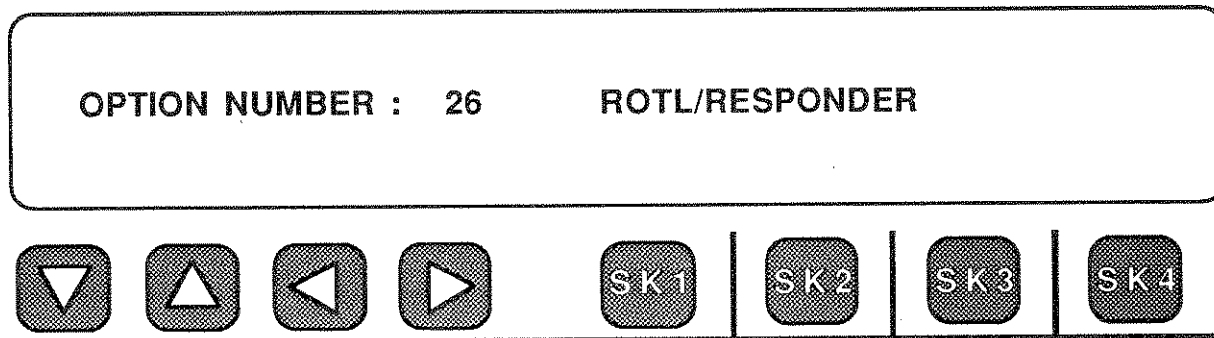

Press any softkey under the display and the main menu will appear:

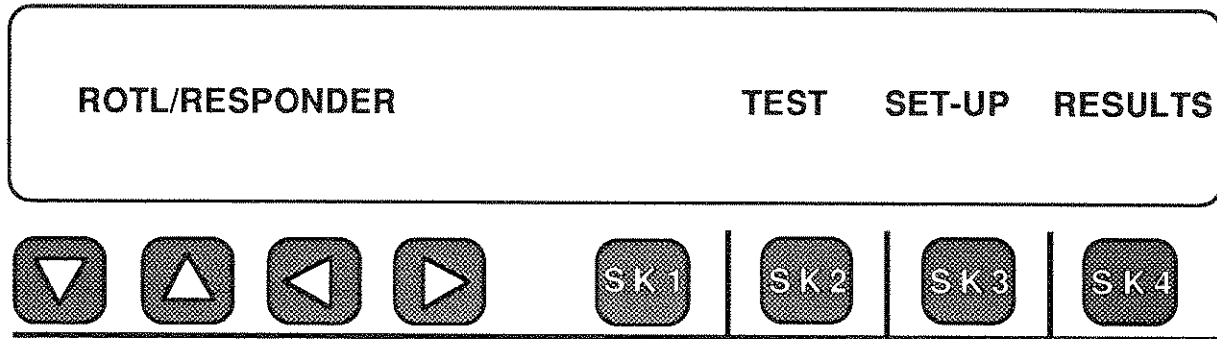

To begin, press Softkey 3 (under SET-UP). The 930A display changes to:

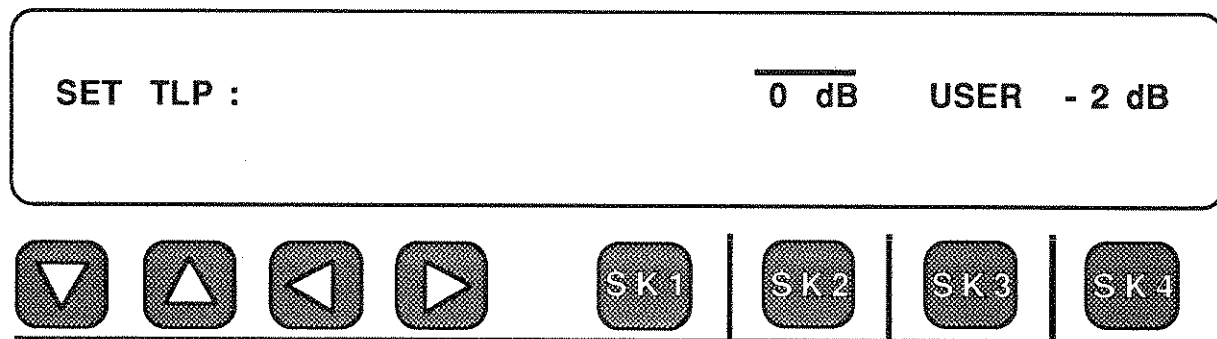

Press Softkey 2 if the set is connected at a 0 dB point, or Softkey 4 if the set is connected at a -2 dB point. Press Softkey 3 under USER, if you wish to set Send or Receive TLP values other than 0 or -2 dB. The 930A display will then change to:

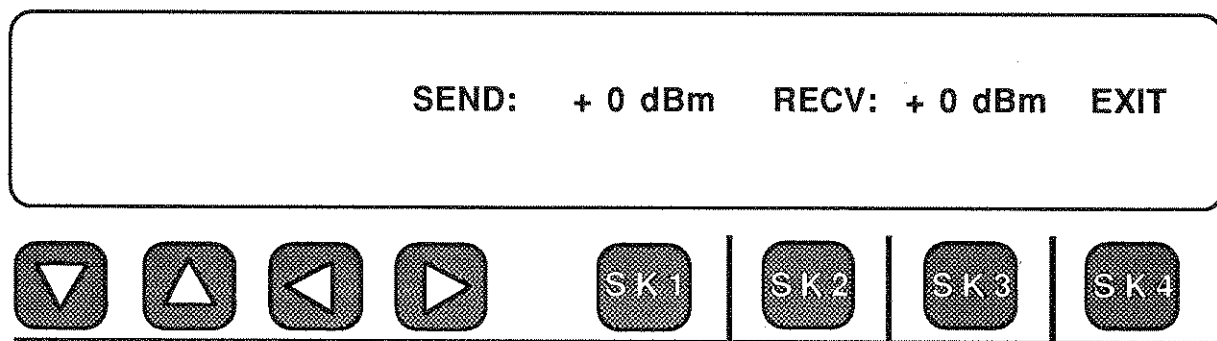

Press Softkey 1 to change the SEND TLP. The range is +7 dB to -25 dB. Use the keypad to enter your choice and press ENTER to complete the selection. Press Softkey 3 to change the RECEIVE TLP. The range is + 7 dB to -16 dB. Use the keypad to enter your selection and then press ENTER. When you have finished press Softkey 4 under EXIT and the next display will appear.

You may also select **SRL-LO** and/or **SRL-HI**. **Return Loss testing** is not standard in all far-end responders. If you get a far-end "failed" response from the 930A, you will know the far-end does not have Return Loss capability. Press the **OPTION MENU** key to return to the main menu and begin testing toward standard responders. If you are testing toward a SAGE Model 356E Far End Responder or another 930A, you may press Softkey 4 under **MORE** to select additional tests.

The standard code 105 transmission tests which can be performed by the 930A are briefly described below:

1. **LOSS** tests the two-way loss at 1004 Hz, 0 dBm.
2. **GAIN/SLOPE** tests the two-way loss at 404 Hz, 1004 Hz, and 2804 Hz. All tone levels are at -16 dBm.
3. **NOISE** tests **C-Message** noise in both directions and tests two-way **C-Notch** noise using a -16 dBm, 1004 Hz holding tone.
4. **ERL, SRL-LO and SRL-HI** tests the two-way **return loss** for each of the three types.

The enhanced responder transmission tests also include the following:

5. **FREQ SWP** tests two-way attenuation distortion.
6. **S/N** tests two-way signal-to-noise ratio.
7. **3K FLAT** tests 3 KHz flat-weighted noise in both directions.
8. **P/AR** tests Peak-To-Average ratio in both directions.
9. **INTERMOD** tests two-way 4-Tone Intermodulation Distortion.
10. **JIT HI** tests phase and amplitude jitter in 20-300 Hz band in both directions.
11. **JIT LO** tests phase and amplitude jitter in 4-300 Hz band in both directions.
12. **EDD** tests Forward and Return Reference Envelope Delay.
13. **IMP/HITS** tests three-level Impulse Noise, Phase Hits, Gain Hits, and Dropouts in both directions. Test length and other parameters are user selectable.

Once you select the tests you want, the set-up phase of the test procedure is finished. This need not be repeated unless the **TLP** changes, or different tests are wanted.

Press the **OPTION MENU** key, or **Softkey 4** under **EXIT**, to get back to the main menu and the 930A display will return to:

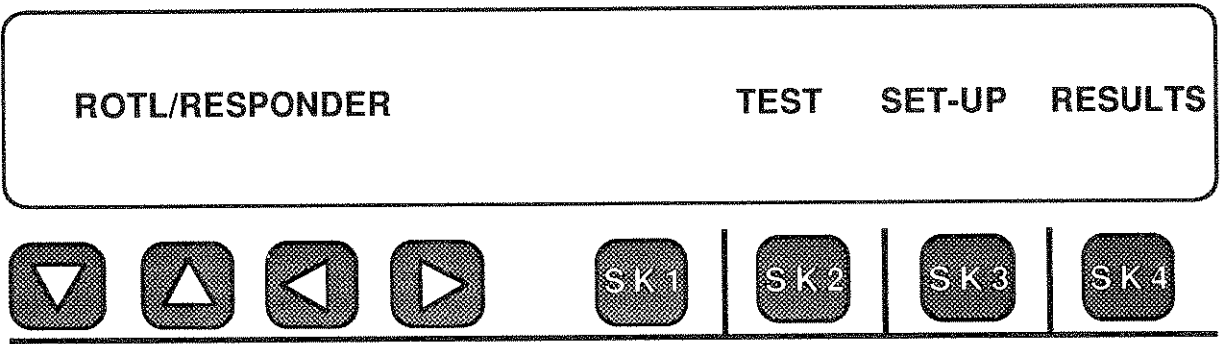

To begin the test procedure, press **Softkey 2** (under **TEST**). The 930A display will change to the following:

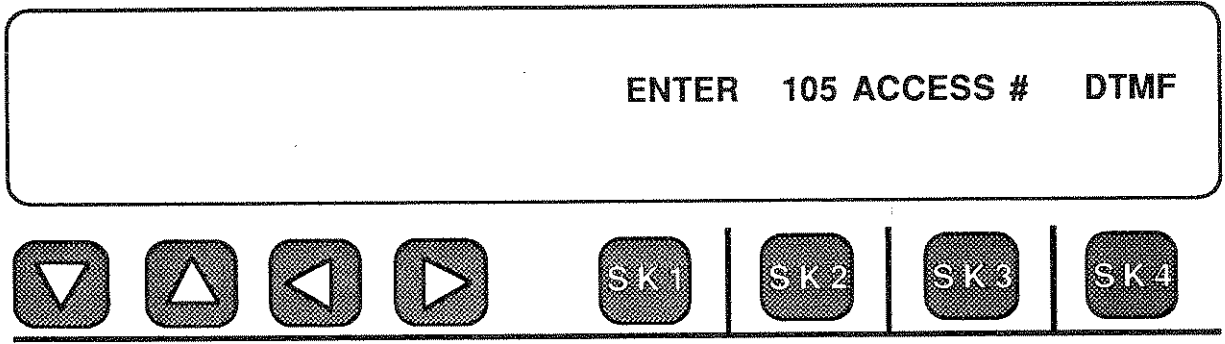

The digit sequence may be **DP**, **MF** or **DTMF**. You select the appropriate type of signaling using **Softkey 4**. In the example above, **DTMF** output pulsing has been selected.

Now enter the phone number of the far end test line using the numeric keypad. An example of a **DTMF** phone number is shown below:

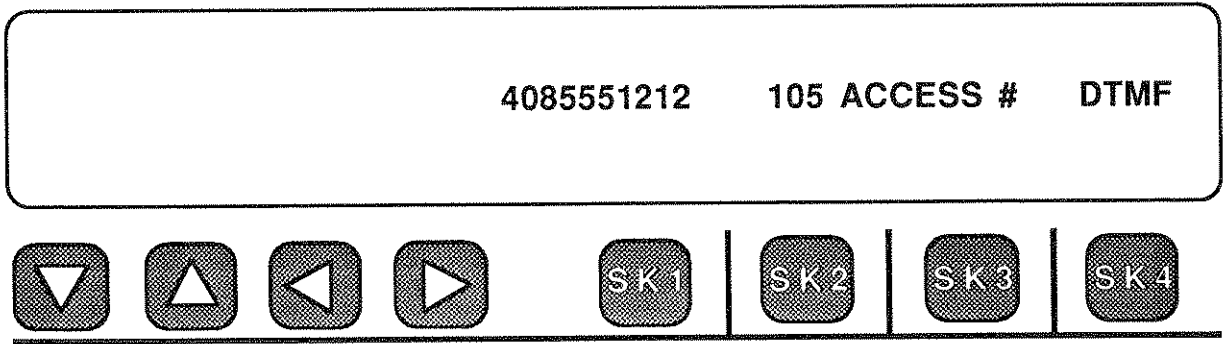

After you have entered the correct phone number, place the front panel hook switch in the **OFF HOOK** position to seize the line and send the call. When the far end has been accessed, you will hear a series of test progress tones as the 930A goes through the series of tests which were programmed.

For example, if you had selected only Loss, Noise and Noise with Tone, and Echo Return Loss measurements, the following series of displays would be shown on the 930A as it performed each measurement.

Notice that **Call Completion time is measured first**. For this example, typical displays might be:

CALL COMPLETION TIME: 7.4 SEC.



LOSS : NEAR -7.6 dB FAR -7.7 dB



NOISE : NEAR 14dBrn FAR 15 dBrn



| | | | | | | | |
|--------------|--|------|--------|-----|--------|-----|-----|
| NOISE/TONE : | | NEAR | 27 dBm | FAR | 34 dBm | | |
| | | | | SK1 | SK2 | SK3 | SK4 |

| | | | | | | | |
|-------------|--|------|-------|-----|-------|-----|-----|
| RLOSS ERL : | | NEAR | 37 dB | FAR | 29 dB | | |
| | | | | SK1 | SK2 | SK3 | SK4 |

The **NEAR** results equate to **Far-to-Near** results given by CAROT. Similarly the **FAR** results equate to the **Near-to-Far** results.

The 930A sequences through these tests and flashes the results briefly. The results are also stored in battery-backed **CMOS RAM**. If a printer is connected, the test results will be printed out as they occur. Once the sequence of tests has been completed the 930A releases the far-end responder.

At the end, the 930A returns to the main display shown below:

| | | | | | | | |
|----------------|--|------|--------|---------|-----|-----|-----|
| ROTL/RESPONDER | | TEST | SET-UP | RESULTS | | | |
| | | | | SK1 | SK2 | SK3 | SK4 |

To view the results of the tests (which were flashed by at a reasonably rapid rate during testing), press Softkey 4 (under **RESULTS**). The 930A will recall the stored results of the previous test sequence.

In the previous example, after pressing Softkey 4, the **CALL COMPLETION** test results would have appeared as:

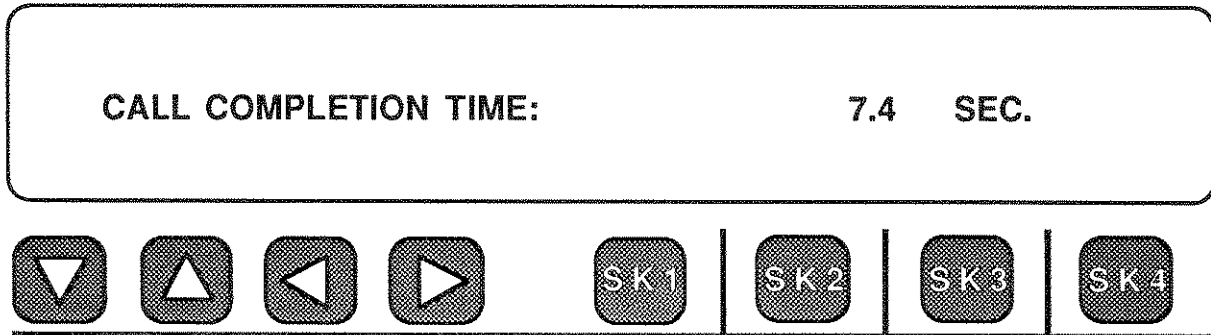

You can then use the **UP/DOWN** arrow keys, or Softkey 1 to scroll through the various test results. For instance, pressing Softkey 1 would bring up:

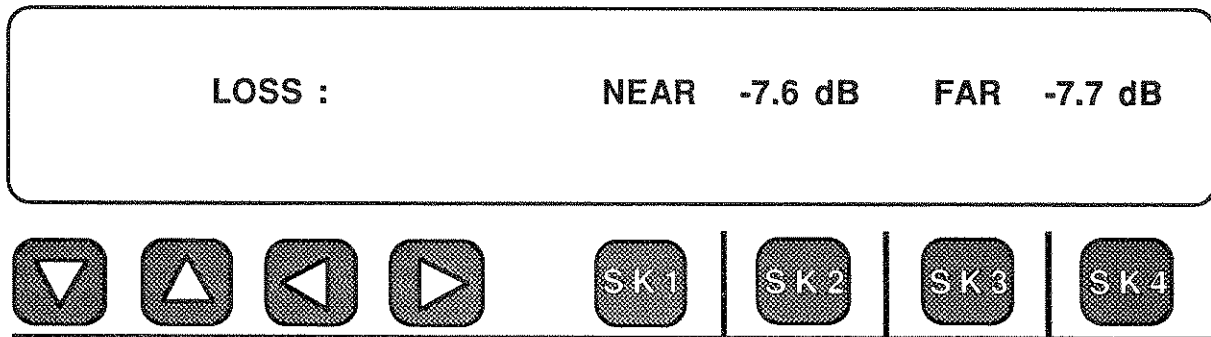

Continued pressing of Softkey 1, or the arrow keys, would enable you to review all of the test results in a convenient manner. The results are retained in memory until a new series of tests is begun and the old results are overwritten. Press the **Option Menu** key, or any front panel function key, to return to the main **ROTL/RESPONDER** menu display.

5-27 USING THE 930A TO INTERROGATE A ROTL (MENU OPTION 27)

The Interrogator portion of Option 930A-12 lets the 930A command a ROTL from a ROTL access port or over a dial-up line. The 930A supports two-way transmission testing to type 105 test lines and one-way transmission testing to type 100 and 102 test lines. Operational balance and long term (BALT) tests can also be performed, but support for these tests is limited to the return of audible tones to the operator. A typical test line arrangement showing the 930A connected to the near end switch ROTL access port is shown below.

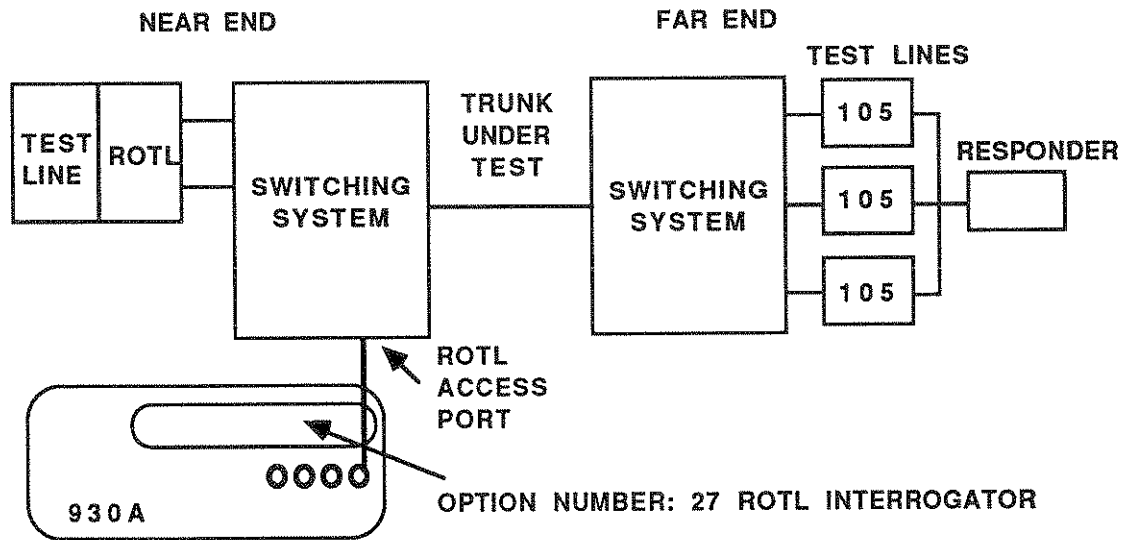

INTERROGATOR CONNECTED AT ROTL ACCESS PORT

Since the ROTL access port is usually tied up by the CAROT controller, the 930A can gain test access over any dial-up line, or T-1 PCM channel at the DSX, and interrogate the ROTL from there.

Before starting to test, you must set the 930A to the correct TRUNK TYPE. Connect the 930A to either the ROTL access port, the dial-up line, or the DSX (Select the Trunk Type for the connection between the 930A and the ROTL, not the line under test).

You can set up the 930A as an Interrogator by performing the following steps:

Press the Option Menu  Option Menu key.

Use the UP/DOWN   arrow keys

to select Menu Option 27: ROTL INTERROGATOR

The Model 930A display will appear as follows:

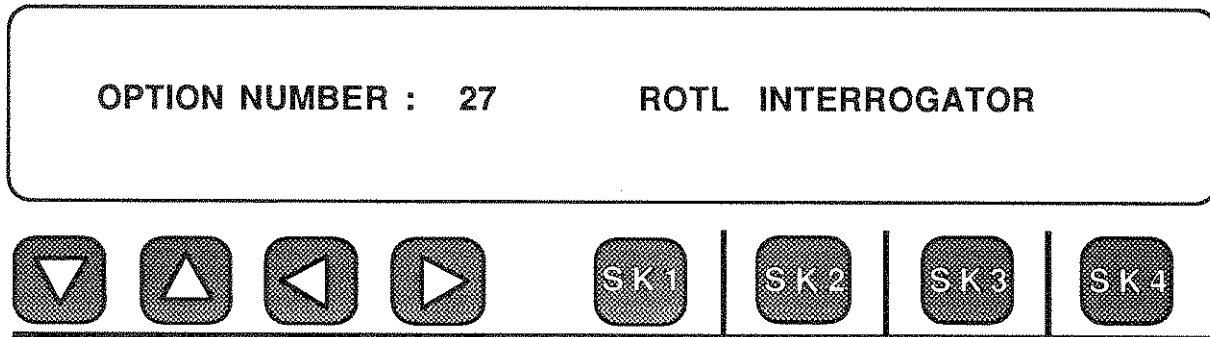

Press any softkey under the display and it becomes:

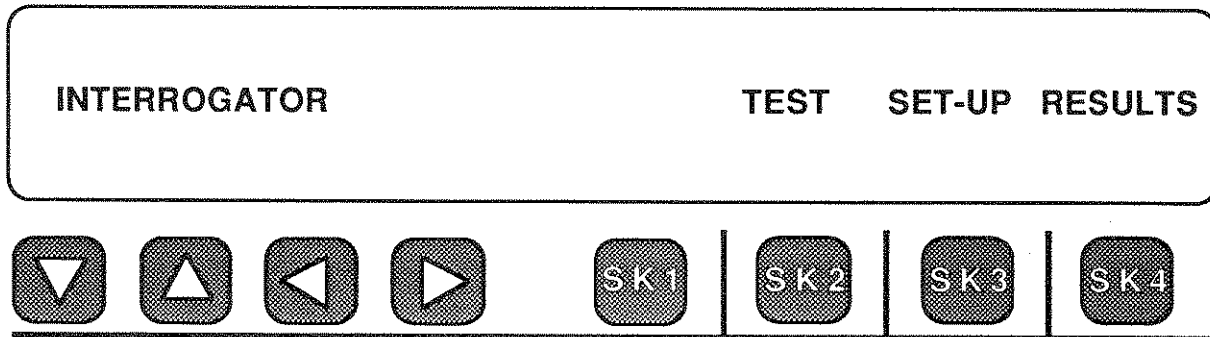

For this example, we will start from the beginning using the factory default displays. This means we have to start with the **SET-UP** menu before we can test.

5-27.1 ENTERING THE ROTL PRIMING DIGITS

To begin, press Softkey 3 (under **SET-UP**). The 930A display will then briefly flash the following:

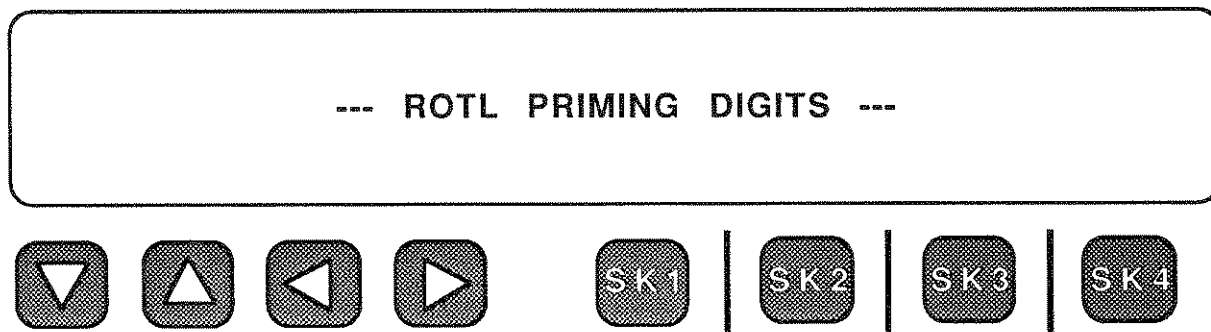

If no priming digits have been entered, the display will prompt you by showing the following:

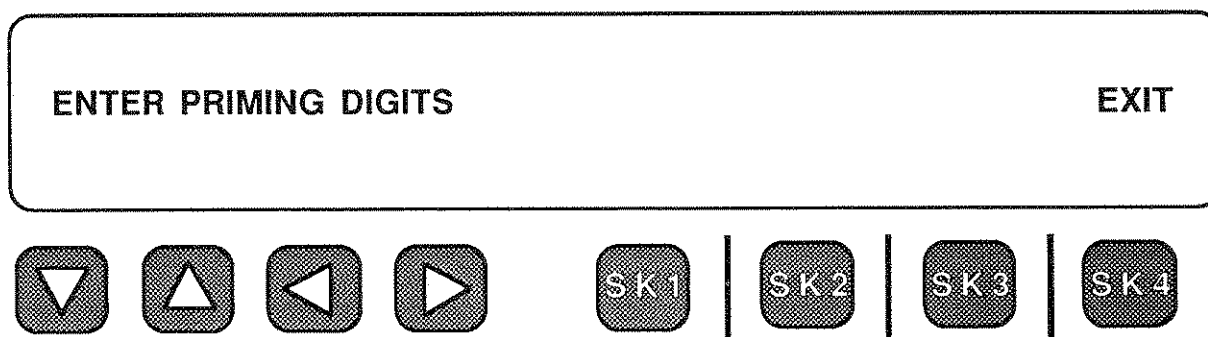

If priming digits had previously been entered, as would normally be the case, then the last string of priming digits would have been displayed instead of the words "ENTER PRIMING DIGITS". If an unwanted string of digits is present, they can be removed by pressing the **CLR** key. New **ROTL** priming digits may now be entered by using the numeric keypad. **First**, however, it is necessary to say a few words about **ROTL** priming digit sequences and how the 930A displays them.

IMPORTANT NOTE:

ROTL priming digits are always MF digits. The 930A has been set to automatically insert the KP and ST delimiters. You only have to enter the numerical digits. This is a deviation from the way in which the DIAL/RING Function operates.

You can enter up to thirty (30) digits in the **ROTL** priming digits field. These digits consist of the Test Type (up to 3 digits long), the Trunk Identification Number (up to 7 digits long) and the far-end Test Line number (up to 11 digits long). The 930A lets you enter blank characters between the groups for readability. These blank characters are inserted by the **UP** Arrow key and have no effect on outpulsing.

A typical 930A display of **ROTL** priming digits, with blank spaces inserted to separate the groups, might appear as shown below:

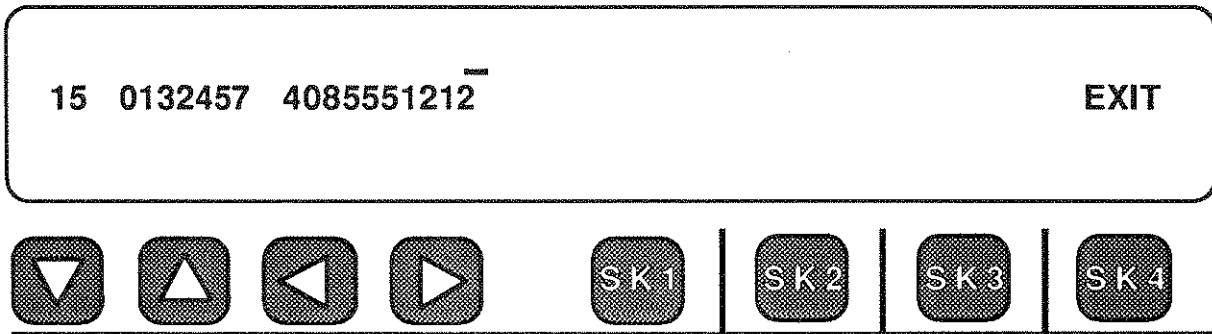

In this example, the first two digits identify the Test Type (Transmission Test with Busy Override using a 105 Type test line in this case), the second group of 7 digits might be the Trunk Appearance Number (**TAN**) of a No. 4 ESS for example, and the last group is an example of a Far End Test Line number.

ROTL priming digit sequences vary in accordance with the type and vintage of switching equipment, the type of testing to be performed, the test lines available and their manufacturer. Tables of Priming Digit Formats for recent AT&T switches and for Northern Telecom, GTE and ITT switches, are provided at the end of this section.



You can edit the string of priming digits to insert or delete individual characters, rather than re-entering the entire string if a mistake, or an omission, has occurred. The **LEFT** and **RIGHT** Arrow keys move the cursor around the display. The **UP** Arrow key inserts a blank space. The **DOWN** arrow key deletes an unwanted digit.

The next section outlines the rest of the **SET-UP** procedure after you have entered the **ROTL** priming digits.

5-28 TESTING TO TYPE 125 TRANSPONDERS (MENU OPTION 28)

This option allows you to place test calls to responders that do not use the standard Type 105 format. Specifically, the Hekimian Laboratories Type 125 and 135 transponders.

To begin testing, connect the 930A to the trunk under test and select the correct Trunk Type on the instrument. Now do the following:

Press the Option Menu  Option Menu key.
Use the UP/DOWN   arrow keys
to select Menu Option 28: TRANSPONDER TEST.

Press any softkey to enter the option and you will see the following display:

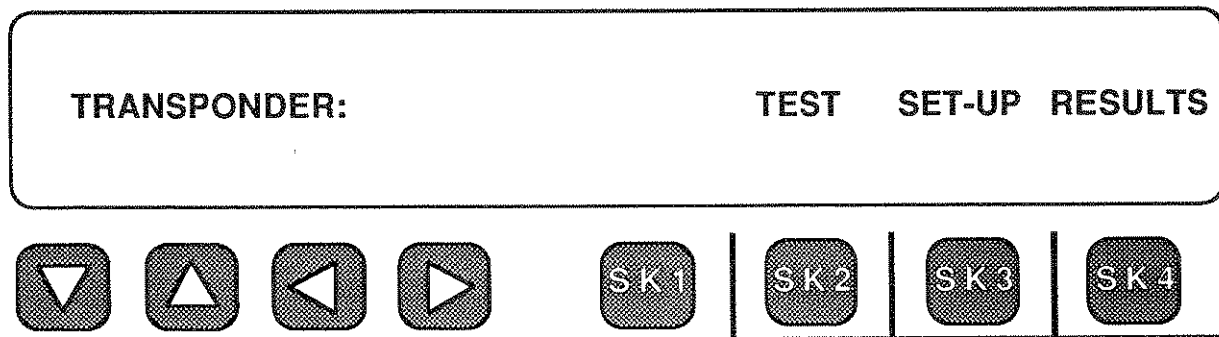

5-28.1 HOW TO SET UP MENU OPTION 28: TRANSPONDER TEST

If you have not previously set up for a transponder test, press Softkey 3 under **SET-UP**. You will see this display:

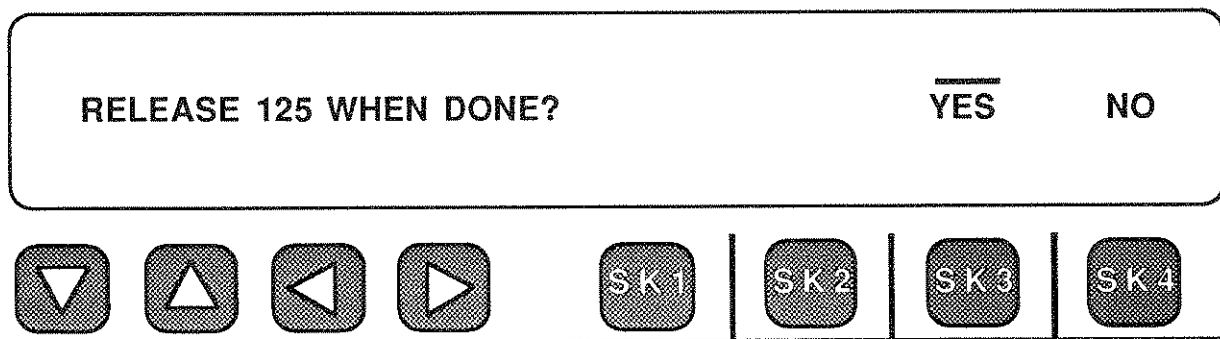

If you press Softkey 3 under **YES**, the 125 transponder will be automatically released after the selected tests are performed. If you press Softkey 4 under **NO**, the transponder will not be released at the end of the tests. This allows you to perform further tests manually.

Once you have pressed either softkey, the display will advance to:

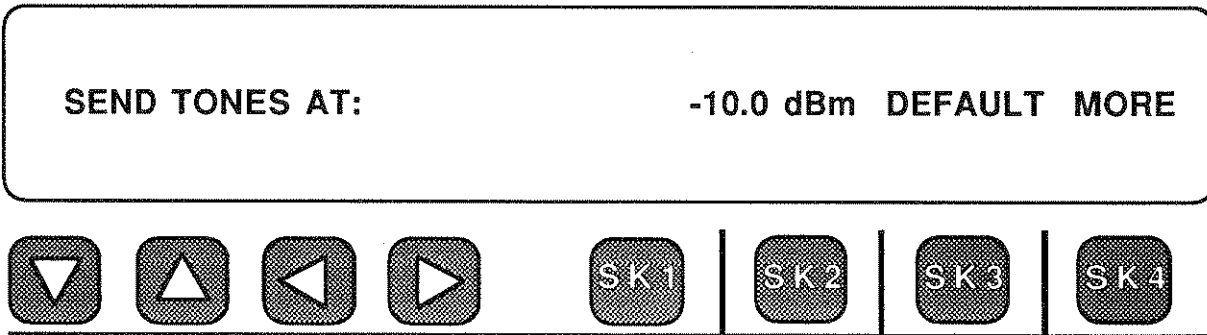

This screen is used to select the level at which test tones will be sent and received. You must set this level to match the level to which the 125 transponder at the far end has been set. Transponders may be strapped to send at either -10 dBm or -20 dBm. The 930A can be set to either of these levels, or to some other level that takes an arbitrary pad into account. For accurate test results, the 930A and the far end transponder must be sending tones at the same level.

Press Softkey 3 under **DEFAULT** to select -10.0 dBm level.

Use the numeric keypad to enter any other level.

Press Softkey 4 under **MORE** to continue with the set-up.

You will then see the test selection screen:

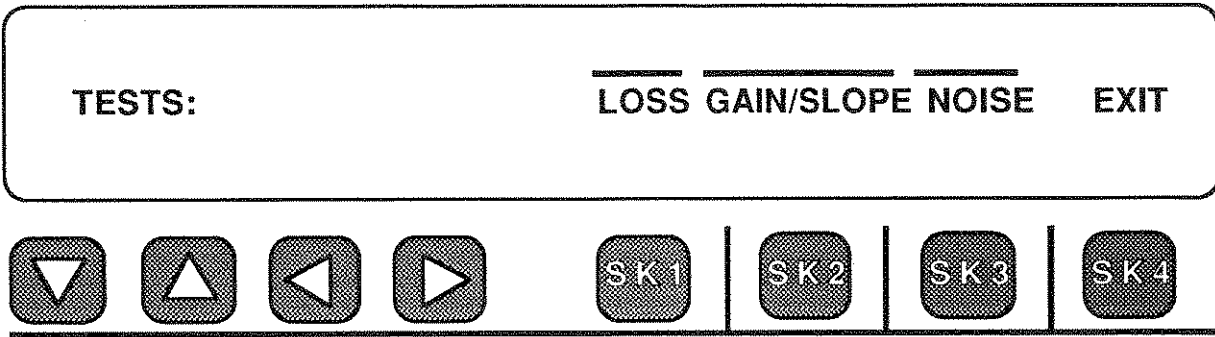

LOSS tests loss at 1004 Hz.

GAIN/SLOPE tests loss at 404 Hz, 1004 Hz and 2804 Hz. The **GAIN/SLOPE** test includes **LOSS**. It is redundant to select them both.

NOISE measures C-Message and C-Notch noise.

There will be a highlighted cursor over any selected test. Press the softkey beneath the test to toggle it on or off. When the desired tests are highlighted, press Softkey 4 under **EXIT**.

In **COMPUTER remote mode**, all previous selections will be cleared when the softkey under **SET-UP** is pressed. Send an ASCII "J" to select **LOSS**, an ASCII "K" to select **GAIN/SLOPE**, and an ASCII "L" to select **NOISE**.

When all the selections are made, press Softkey 4 under **EXIT**. Your set up will be retained in battery-backed CMOS RAM. You will not need to use the **SET-UP** function again unless you wish to change the set up.

You will be returned to the main transponder menu:

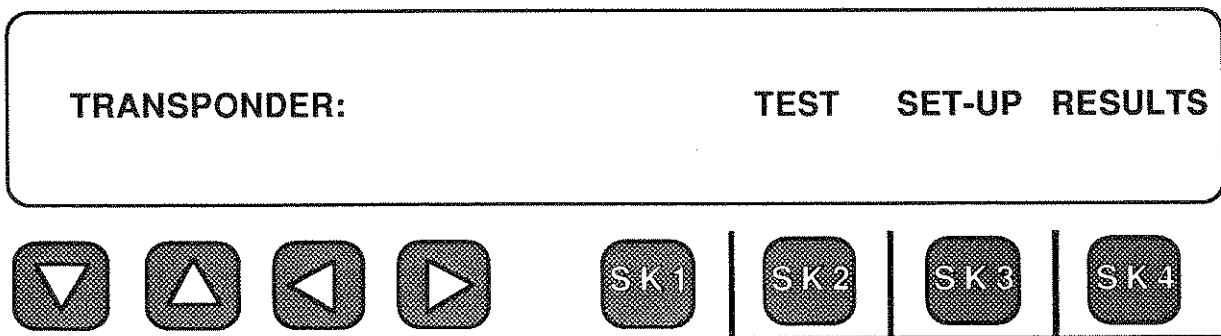

5-28.2 HOW TO TEST TO A TYPE 125 TRANSPONDER

When you are ready to begin testing, press Softkey 2 under **TEST** on the main transponder display shown on the previous page. You will see a display similar to:

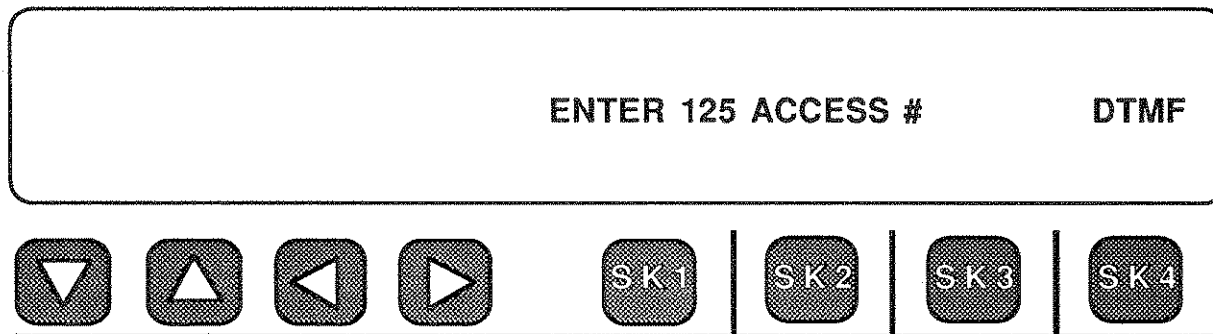

The number most recently entered in the **DIAL/RING** mode will usually be displayed. Press the **CLR** (Clear) key to remove any previous entry and return to a display similar to the one above.

Press Softkey 4, labeled **MF**, **DTMF**, or **DP**, to change the outpulsing format to the type required for your circuit. This will also clear any old numbers.

Enter the access number of the far end transponder using the numeric keypad.

Use the front panel Hook Switch to go off hook and begin testing. The 930A will seize the line, send any digits you have entered in the window, and expect the transponder at the far end to answer the call. If no number has been entered in the window, no digits will be sent. If the 930A is already off hook when you press **TEST**, it will send any displayed digits immediately. For this reason you should make sure the 930A is on hook before pressing the softkey under **TEST**. In **PRINTER** remote mode, the 930A will send a time and date stamp and the current access number to the printer to identify the test.

After it has sent the displayed digits, the 930A will look for a 1004 Hz tone from the transponder. If it does not receive the tone within 60 seconds, or if it detects busy, reorder, dial-tone or a non-1004 Hz tone (less than 950 Hz or greater than 1050 Hz), it will abort the test with one of these messages:

| | |
|------------------------|-----------------|
| ABORT: BUSY | xx.x SEC |
| ABORT: REORDER | xx.x SEC |
| ABORT: DIALTONE | xx.x SEC |

| | |
|-------------------------|-----------------|
| ABORT: TONE | xx.x SEC |
| ABORT: DEAD LINE | xx.x SEC |
| ABORT: RINGING | xx.x SEC |
| ABORT: SPEECH? | xx.x SEC |

If the 930A successfully detects 1004 Hz within 60 seconds, it will instead display the message: **CALL COMPLETION TIME: xx.x SECS.**

In **PRINTER** remote mode, a copy of the display will be sent to the printer.

In **COMPUTER** remote mode, the 930A will send a prompt ">" and a bell when it detects 1004 Hz or when it aborts a test. You may inspect the 930A display for the word "**ABORT:**" or "**CALL**" to determine which has occurred. If the display shows "**CALL COMPLETION TIME:**", the xx.x seconds is the time from the last digit outputted to the receipt of the 1004 Hz envelope. If the display shows "**BUSY**", "**REORDER**", "**DIAL-TONE**" or "**TONE**", the xx.x seconds is the network response time. If the display shows "**DEAD LINE**", "**RINGING**" or "**SPEECH?**", the xx.x seconds are not significant.

The 930A will now perform the selected tests. The results of each test will be displayed at the end of each test. In **PRINTER** remote mode, the results of each test will be sent to the printer as they occur. In **COMPUTER** remote mode, a bell will be sent to the computer at the conclusion of each test. The test results can be read from the display at that time.

The format of the possible results is:

| | | | | |
|--------------------|-------------|-----------------|------------|-----------------|
| LOSS: | NEAR | +nn.n dB | FAR | +nn.n dB |
| SLOPE 404: | NEAR | +nn.n dB | FAR | +nn.n dB |
| SLOPE 1004: | NEAR | +nn.n dB | FAR | +nn.n dB |
| SLOPE 2804: | NEAR | +nn.n dB | FAR | +nn.n dB |
| NOISE: | NEAR | nn dBrn | FAR | nn dBrn |
| NOISE/TONE: | NEAR | nn dBrn | FAR | nn dBrn |

The **NEAR** measurement is really the **FAR-TO-NEAR** measurement and the **FAR** measurement is the **NEAR-TO-FAR** measurement. Some transponders do not support the C-Message noise test. In such cases, the **NEAR** noise measurement will be meaningful but the **FAR** noise measurement will not. There is no failure indication from the far end for unsupported tests. If unlikely results appear in the **FAR** noise measurement, consult the documentation provided with your transponder.

When all the selected tests have been completed, you will be returned to the main transponder display.

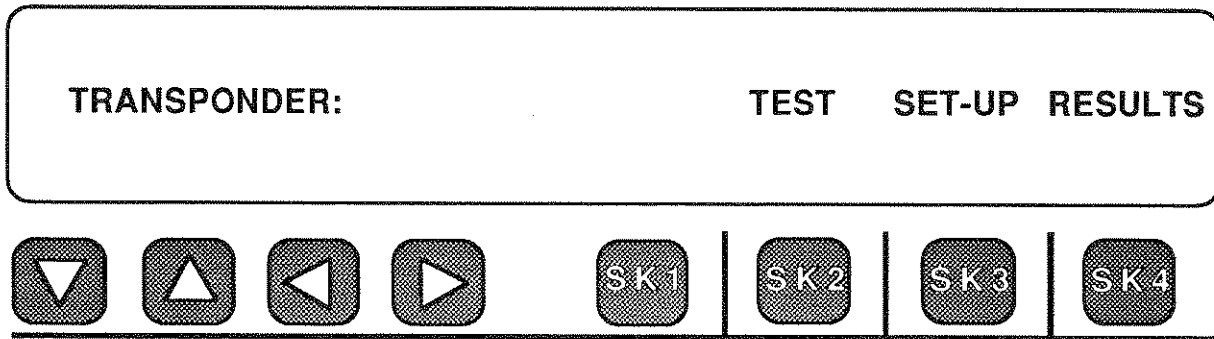

If the 930A was in **COMPUTER** remote mode, it sends another prompt when testing is complete.

The transponder will be released automatically if you have selected this option in the set up. Otherwise it will remain active. Use the hook switch to put the 930A back on hook and release the telephone line when you finish testing.

To examine the test results, press Softkey 4 under **RESULTS**. You will see either the Call Completion time, such as:

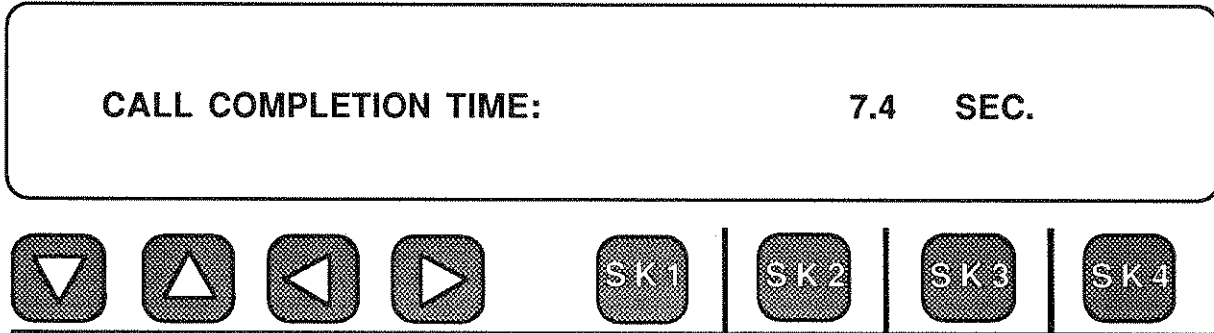

or a call failure message, such as:

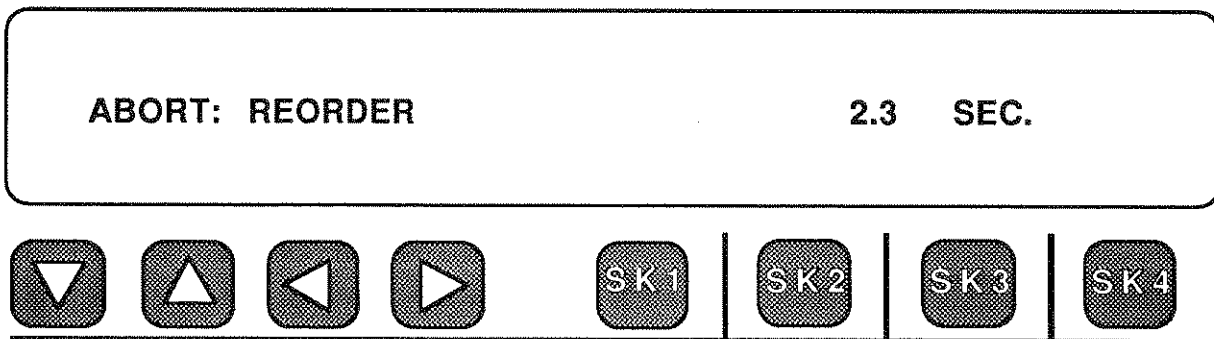

If a call failure message is displayed, there are no other results. Press the **OPTION MENU** key to return to the main menu.

If the call completion time is displayed, you are seeing the time elapsed from the last outpulsed digit in the 125 access number to the receipt of the 1004 Hz envelope.

Press **Softkey 1** or the **UP/DOWN** arrow keys to scroll through the remaining test results.

5-28.3 TABLES OF ROTL PRIMING DIGITS

The following Tables are intended for two-way Transmission They are not complete lists of all **ROTL Priming Digits** for all types of tests such as Terminal Balance, Connection Appraisal, etc.

**FIGURE 5-2
STEP-BY-STEP OFFICE MINI-ROTL PRIMING DIGIT FORMAT**

| TEST TYPE | TEST LINE | DIGITS | | | | | | | | | | | | | | | |
|--------------------|-----------|--------|---|---|----------|------|-------------------------|---|---|---|----|----|----|----|----|----|----|
| | | 1 | 2 | 3 | 4 | 5 | 6 | 7 | 8 | 9 | 10 | 11 | 12 | 13 | 14 | 15 | 16 |
| TRANSMISSION TESTS | 100 | 0 | 0 | 0 | TRUNK ID | NOTE | FAR END TESTLINE NUMBER | | | | | | | | | | |
| | 102 | 0 | 2 | 0 | | | | | | | | | | | | | |
| | 105 | 0 | 5 | 0 | | | | | | | | | | | | | |

NOTE: The seventh digit depends upon the Trunk Type

| DIGITS | TRUNK TYPE |
|--------|--|
| 0 | Dial Pulse on Loop Supervision Trunk |
| 1 | Dial Pulse on Loop Supervision with Stop Dial |
| 2 | Dial Pulse on Simplex Supervision Trunk |
| 3 | Dial Pulse on Simplex Supervision with Stop Dial |
| 4 | MF Signaling on Loop Supervision Trunk |
| 5 | MF Signaling on Simplex Supervision Trunk |

5ESS Priming Chart

| Test Type | Line | 1 | 2 | 3 | 4 | 5 | 6 | 7 | 8 | 9 | 10 | 11 | 12 | 13 | 14 | 15 | 16 | 17 | 18 | | |
|-------------------------|------|---|---|--------------------------------------|--------------------|---|---|---|---------------|---|----|----|----|----|----|----|----|----|----|--------------------------|--|
| Transmission Tests | 100 | 0 | 0 | 0 | Trunk Group Number | | | | Member Number | | | | | | | | | | | Far End Test Line Number | |
| | 102 | 0 | 2 | 0 | | | | | | | | | | | | | | | | | |
| | 105 | 0 | 5 | 0 | | | | | | | | | | | | | | | | | |
| Out of Service Override | 100 | 1 | 0 | 0 | | | | | | | | | | | | | | | | | |
| | 102 | 1 | 2 | 0 | | | | | | | | | | | | | | | | | |
| | 105 | 1 | 5 | 0 | | | | | | | | | | | | | | | | | |
| Connection Appraisal | 100 | 6 | 0 | Far End Test Line Number < 12 Digits | | | | | | | | | | | | | | | | | |
| | 102 | 6 | 2 | | | | | | | | | | | | | | | | | | |
| | 105 | 6 | 5 | | | | | | | | | | | | | | | | | | |

FIGURE 5-3 5ESS PRIMING CHART

**FIGURE 5-4
STEP-BY-STEP OFFICE EXPANDED FORMAT**

| TEST TYPE | TEST LINE | DIGITS | | | | | | | | | | | | | | | | | | |
|---------------------------------------|-----------|--------|---|----------|---|---|---|------|---|---|----|----|----|----|----|----|----|----|----|-------------------------|
| | | 1 | 2 | 3 | 4 | 5 | 6 | 7 | 8 | 9 | 10 | 11 | 12 | 13 | 14 | 15 | 16 | 17 | 18 | |
| TRANSMISSION TESTS | 100 | 0 | 0 | TRUNK ID | | | | NOTE | | | | | | | | | | | | FAR END TESTLINE NUMBER |
| | 102 | 0 | 2 | | | | | | | | | | | | | | | | | |
| | 105 | 0 | 5 | | | | | | | | | | | | | | | | | |
| TRANSMISSION TESTS WITH BUSY OVERRIDE | 100 | 1 | 0 | | | | | | | | | | | | | | | | | |
| | 102 | 1 | 2 | | | | | | | | | | | | | | | | | |
| | 105 | 1 | 5 | | | | | | | | | | | | | | | | | |

NOTE: The seventh digit depends upon the Trunk Type

| DIGITS | TRUNK TYPE |
|--------|--|
| 0 | Dial Pulse on Loop Supervision Trunk |
| 1 | Dial Pulse on Loop Supervision with Stop Dial |
| 2 | Dial Pulse on Simplex Supervision Trunk |
| 3 | Dial Pulse on Simplex Supervision with Stop Dial |
| 4 | MF Signaling on Loop Supervision Trunk |
| 5 | MF Signaling on Simplex Supervision Trunk |

**FIGURE 5-5
NO. 1 ESS ROTL PRIMING DIGITS FORMAT**

| TEST TYPE | TEST LINE | DIGITS | | | | | | | | | | | | | | | | | | | |
|---------------------------------------|-----------|--------|---|------|----------------------|---|---|---|---|--------------------------|----|----|----|----|----|----|----|----|----|----|----|
| | | 1 | 2 | 3 | 4 | 5 | 6 | 7 | 8 | 9 | 10 | 11 | 12 | 13 | 14 | 15 | 16 | 17 | 18 | 19 | 20 |
| TRANSMISSION TESTS | 100 | 0 | 0 | NOTE | TRUNK NETWORK NUMBER | | | | | FAR-END TEST LINE NUMBER | | | | | | | | | | | |
| | 102 | 0 | 2 | | | | | | | | | | | | | | | | | | |
| | 105 | 0 | 5 | | | | | | | | | | | | | | | | | | |
| TRANSMISSION TESTS WITH BUSY OVERRIDE | 100 | 1 | 0 | | | | | | | | | | | | | | | | | | |
| | 102 | 1 | 2 | | | | | | | | | | | | | | | | | | |
| | 105 | 1 | 5 | | | | | | | | | | | | | | | | | | |

NOTE: The third digit is a modifier digit:

- 1) 0 = Local originating mode.
- 2) 1 = Tandem 1 (2-Wire tandem configuration with transformers).
- 3) 2 = Tandem 2 (4-Wire to 2-Wire tandem configuration without transformers).

**FIGURE 5-6
NO. 4 ESS ROTL PRIMING DIGITS FORMAT**

| TEST TYPE | TEST LINE | DIGITS | | | | | | | | | | | | | | |
|---------------------------------------|-----------|--------|---|--------------------------------------|---|---|---|---|-------------------------|---|----|----|----|----|----|----|
| | | 1 | 2 | 3 | 4 | 5 | 6 | 7 | 8 | 9 | 10 | 11 | 12 | 13 | 14 | 15 |
| TRANSMISSION TESTS | 100 | 0 | 0 | TRUNK ID FOR TRUNK APPEARANCE NUMBER | | | | | FAR END TESTLINE NUMBER | | | | | | | |
| | 102 | 0 | 2 | | | | | | | | | | | | | |
| | 105 | 0 | 5 | | | | | | | | | | | | | |
| TRANSMISSION TESTS WITH BUSY OVERRIDE | 100 | 1 | 0 | | | | | | | | | | | | | |
| | 102 | 1 | 2 | | | | | | | | | | | | | |
| | 105 | 1 | 5 | | | | | | | | | | | | | |

**FIGURE 5-7
GTD-5, ITT 1210 PRIMING DIGITS FORMAT**

| TEST TYPE | TEST LINE | DIGITS | | | | | | | | | | | | | | | | | | | |
|---------------------------------------|-----------|--------|---|-------------|---|---|---|--------------------------|---|---|----|----|----|----|----|----|----|----|----|----|----|
| | | 1 | 2 | 3 | 4 | 5 | 6 | 7 | 8 | 9 | 10 | 11 | 12 | 13 | 14 | 15 | 16 | 17 | 18 | 19 | 20 |
| TRANSMISSION TESTS | 100 | 0 | 0 | N O T | E | E | E | FAR-END TEST LINE NUMBER | | | | | | | | | | | | | |
| | 102 | 0 | 2 | | | | | | | | | | | | | | | | | | |
| | 105 | 0 | 5 | | | | | | | | | | | | | | | | | | |
| TRANSMISSION TESTS WITH BUSY OVERRIDE | 100 | 1 | 0 | 1 | 2 | 3 | | | | | | | | | | | | | | | |
| | 102 | 1 | 2 | | | | | | | | | | | | | | | | | | |
| | 105 | 1 | 5 | | | | | | | | | | | | | | | | | | |

- NOTE 1:** The third digit is a modifier:
 1) 0= Talk tandem Off-Hook state without a transformer in the talk path.
 2) 1= Talk tandem Off-Hook state with a transformer in the talk path.
- NOTE 2:** Three digit Trunk Group Number
- NOTE 3:** Three digit Trunk Group Member Number

**FIGURE 5-8
DMS 100/200 ROTL PRIMING DIGITS FORMAT**

| TEST TYPE | TEST LINE | DIGITS | | | | | | | | | | | | | | | | | | | |
|---------------------------------------|-----------|--------|---|------------------------|------------------------------------|---------|--------------------------|-------------------------|---|---|----|----|----|----|----|----|----|----|----|----|----|
| | | 1 | 2 | 3 | 4 | 5 | 6 | 7 | 8 | 9 | 10 | 11 | 12 | 13 | 14 | 15 | 16 | 17 | 18 | 19 | 20 |
| TRANSMISSION TESTS | 100 | 0 | 0 | TRUNK GROUP NMBR | TRUNK GROUP MEMBER NUMBER | 100/200 | NOT SENT TO DMS | FAR END TESTLINE NUMBER | | | | | | | | | | | | | |
| | 102 | 0 | 2 | | | | | | | | | | | | | | | | | | |
| | 105 | 0 | 5 | | | | | | | | | | | | | | | | | | |
| TRANSMISSION TESTS WITH BUSY OVERRIDE | 100 | 1 | 0 | 1 | 2 | 3 | | | | | | | | | | | | | | | |
| | 102 | 1 | 2 | | | | | | | | | | | | | | | | | | |
| | 105 | 1 | 5 | | | | | | | | | | | | | | | | | | |

5-29 CALLING A 102 TEST LINE (MENU OPTION 29)

Menu Option 29 was added to Batch Mode to allow easy access to type 102 test lines, commonly known as milliwatt lines. These are dial-up test lines that return a nominal 1004 Hz signal at 0 dBm.

To begin testing, connect the 930A to the trunk under test and select the correct Trunk Type on the instrument. Now do the following:

Press the Option Menu  Option Menu key.

Use the UP/DOWN   arrow keys

to select Menu Option 29: CALL 102 LINE.

Press any softkey to enter the option and you will see the following display:

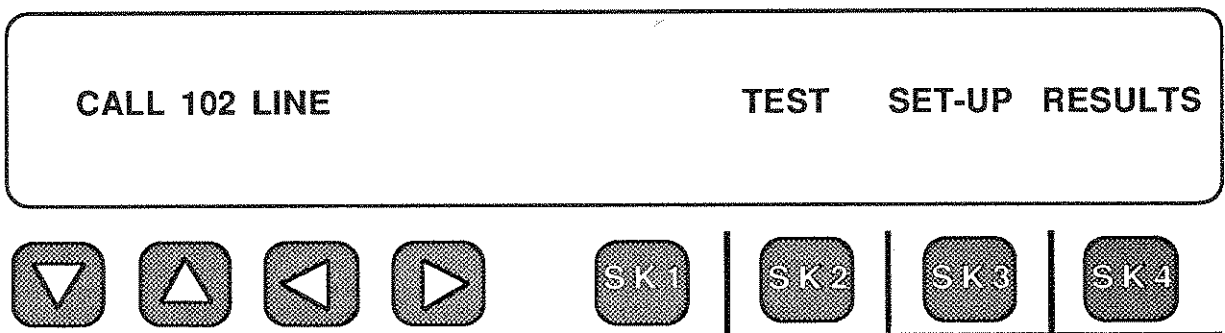

If you have not previously set up for a test, press Softkey 3 under **SET-UP**. You will see this display:

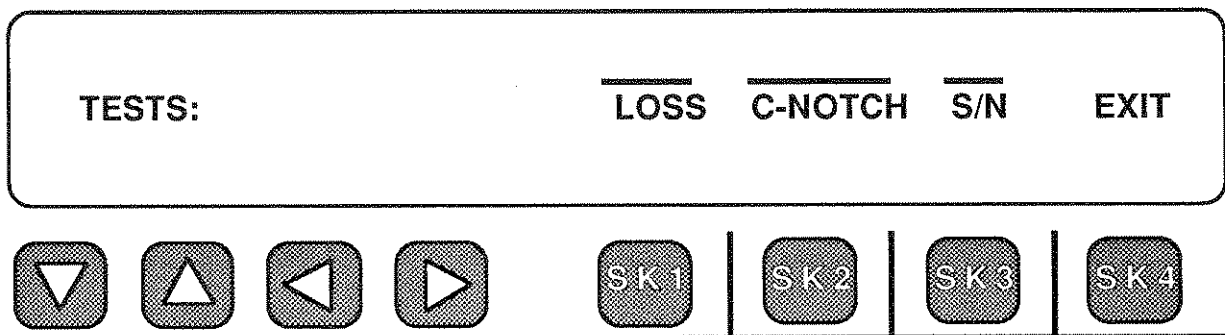

LOSS tests loss at 1004 Hz.

C-NOTCH measures C-Notch noise.

S/N measures signal-to-noise ratio.

There will be a highlighted cursor over any selected test. Press the softkey beneath the test to toggle it on or off. When the desired tests have been highlighted, press Softkey 4 under **EXIT**.

In **COMPUTER remote mode**, all previous selections will be cleared when the softkey under **SET-UP** is pressed. Send an ASCII "J" to select **LOSS**, an ASCII "K" to select **C-NOTCH**, and an ASCII "L" to select **S/N**.

When all the selections are made, press Softkey 4 under **EXIT**. Your set up will be retained in battery-backed CMOS RAM. You will not need to use the **SET-UP** function again unless you wish to change the set up.

You will be returned to the main menu:

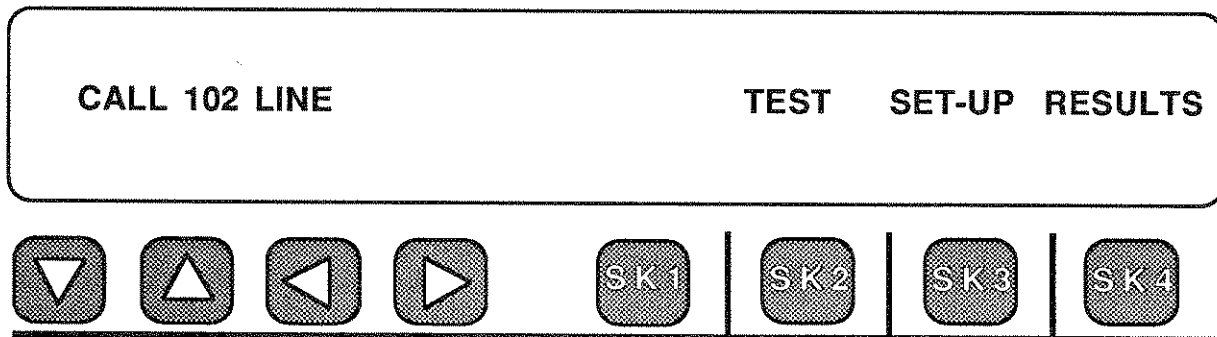

When you are ready to begin testing, press Softkey 2 under **TEST** on the main menu display shown above. You will see a display similar to:

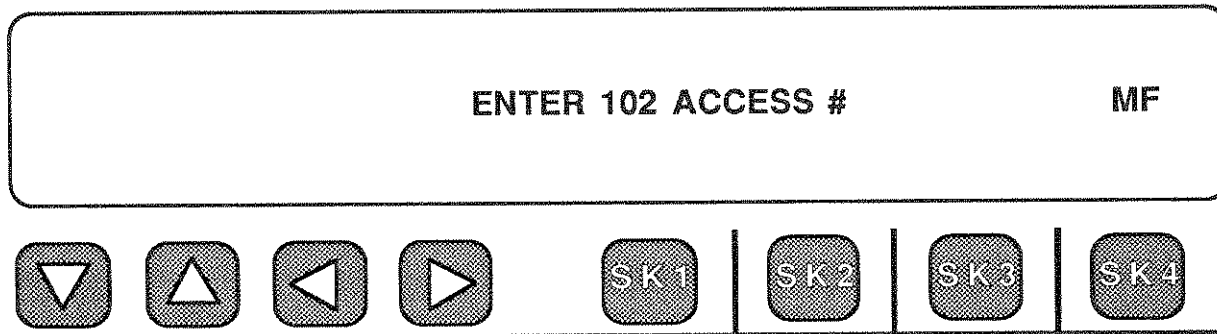

The number most recently entered in the **DIAL/RING** mode will usually be displayed. Press the **CLR** (Clear) key to remove any previous entry and return to a display similar to the one above.

Press Softkey 4, labeled **MF**, **DTMF**, or **DP**, to change the outpulsing format to the type required for your circuit. This will also clear any old numbers.

Enter the access number of the far end transponder using the numeric keypad.

Use the front panel Hook Switch to go off hook and begin testing. The 930A will seize the line, send any digits you have entered in the window, and expect the responder at the far end to answer the call. If no number has been entered in the window, no digits will be sent. If the 930A is already off hook when you press **TEST**, it will send any displayed digits immediately. For this reason you should make sure the 930A is on hook before pressing the softkey under **TEST**. In **PRINTER** remote mode, the 930A will send a time and date stamp and the current access number to the printer to identify the test.

After it has sent the displayed digits, the 930A will look for a 1004 Hz tone from the transponder. If it does not receive the tone within 60 seconds, or if it detects busy, reorder, dial-tone or a non-1004 Hz tone (less than 950 Hz or greater than 1050 Hz), it will abort the test with one of these messages:

| | |
|-------------------------|-----------------|
| ABORT: BUSY | xx.x SEC |
| ABORT: REORDER | xx.x SEC |
| ABORT: DIALTONE | xx.x SEC |
| ABORT: TONE | xx.x SEC |
| ABORT: DEAD LINE | xx.x SEC |
| ABORT: RINGING | xx.x SEC |
| ABORT: SPEECH? | xx.x SEC |

If the 930A successfully detects 1004 Hz within 60 seconds, it will instead display the message: **CALL COMPLETION TIME: xx.x SECS.**

In **PRINTER** remote mode, a copy of the display will be sent to the printer.

In **COMPUTER** remote mode, the 930A will send a prompt ">" and a bell when it detects 1004 Hz or when it aborts a test. You may inspect the 930A display for the word "**ABORT:**" or "**CALL**" to determine which has occurred. If the display shows "**CALL COMPLETION TIME:**", the xx.x seconds is the time from the last digit outputted to the receipt of the 1004 Hz envelope. If the display shows "**BUSY**", "**REORDER**", "**DIAL-TONE**" or "**TONE**", the xx.x seconds is the network response time. If the display shows "**DEAD LINE**", "**RINGING**" or "**SPEECH?**", the xx.x seconds are not significant.

The 930A will now perform the selected tests. The results of each test will be displayed at the end of each test. In **PRINTER** remote mode, the results of each test will be sent to the printer as they occur. In **COMPUTER** remote mode, a bell will be sent to the computer at the conclusion of each test. The test results can be read from the display at that time.

The format of the possible results is:

| | | |
|-----------------------|-------|-------|
| LOSS: | +nn.n | dB |
| C-NOTCH NOISE: | nn | dBrnC |
| SIGNAL/NOISE: | nn | dB |

When all the selected tests have been completed, you will be returned to the main transponder display.

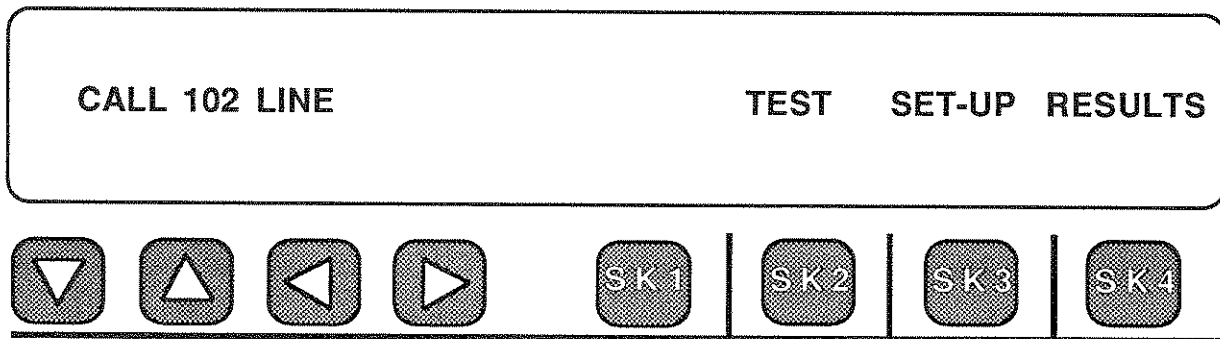

If the 930A was in **COMPUTER** remote mode, it sends another prompt when testing is complete.

Use the hook switch to put the 930A back on hook and release the telephone line when you finish testing.

To examine the test results, press Softkey 4 under **RESULTS**. You will see either the Call Completion time, such as:

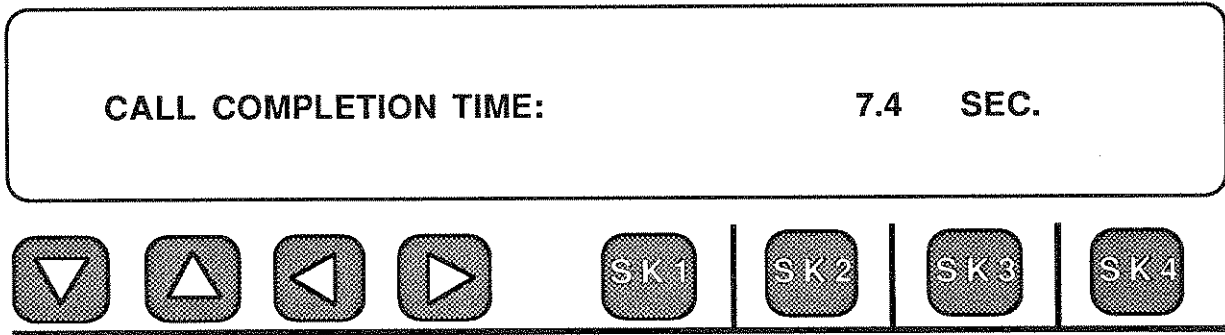

or a call failure message, such as:

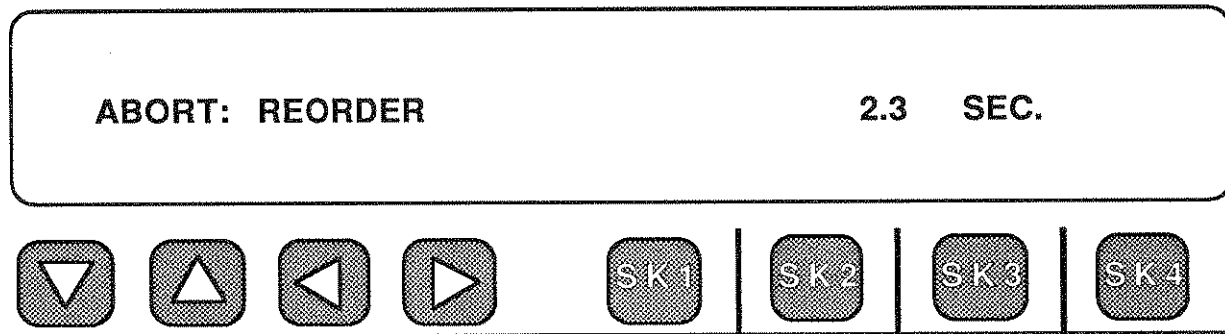

If a call failure message is displayed, there are no other results. Press the **OPTION MENU** key to return to the main menu.

If the call completion time is displayed, you are seeing the time elapsed from the last outputted digit in the 102 access number to the receipt of the 1004 Hz envelope.



Press Softkey 1 or the **UP/DOWN** arrow keys to scroll through the remaining test results.

5-30 HOW TO CHANGE THE TLP (MENU OPTION 30)

Menu Option Number: 30 **ADJUST TLP** lets you manually adjust the transmission level point (TLP) compensation of the 930A and is a standard feature. The Transmit TLP affects the level the 930A sends. The Receive TLP affects the level sensitivity of the 930A receiver. This function **is not** normally used when testing 2-wire analog, or PCM (T-Carrier), trunks since these are usually a 0 dB TLP.

To set the TLP level of the transmit or receive section of the 930A, perform the following steps:

Press the OPTION MENU  **Option Menu** function key.

Use the UP/DOWN   arrow keys to select Menu Option 30: ADJUST TLP.

The 930A display will appear as shown below:

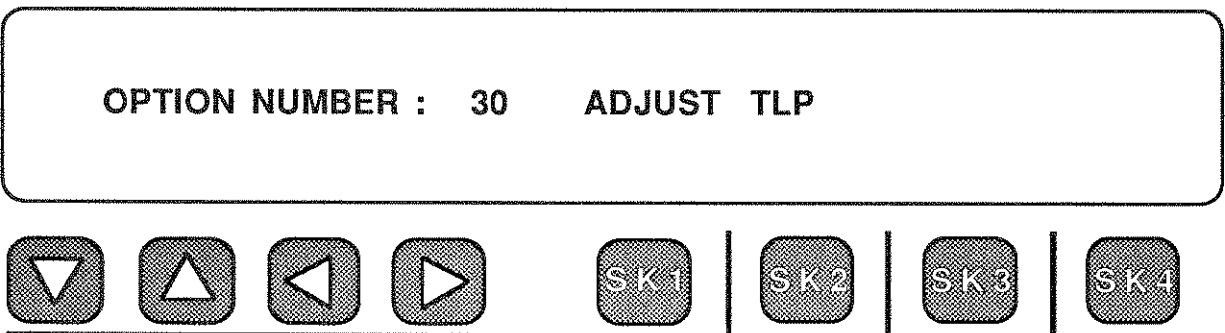

Pressing any softkey under the display will enter the menu. Once inside Menu Option 30, the display is:

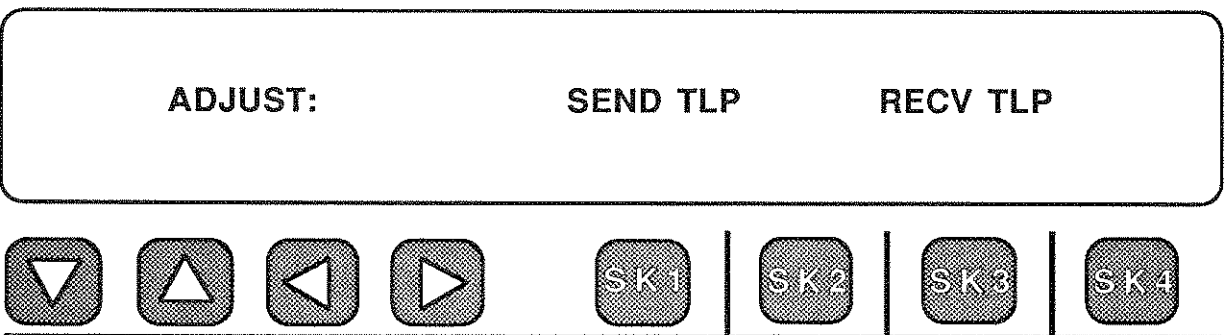

To adjust the Transmit **TLP**, press Softkey 1 (under **SEND TLP**) and the 930A display will show the current **TLP** setting. For example:

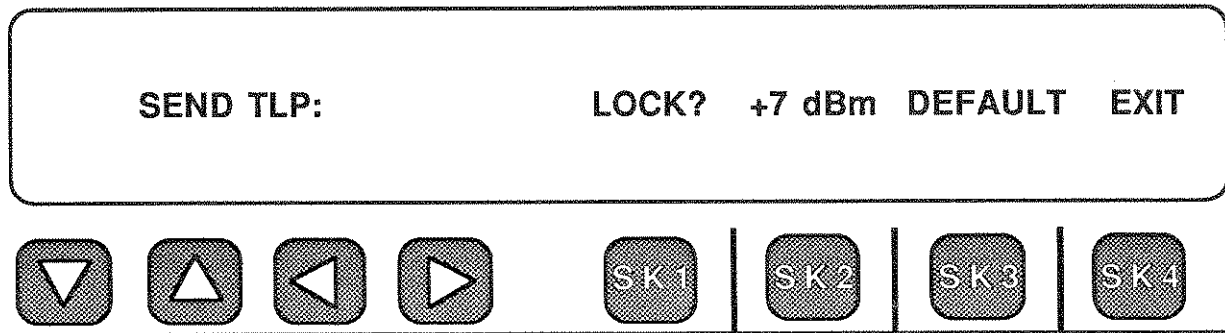

Here the previous **TLP** was +7 dB. The 930A also asks whether you want to lock in that value as the start-up default. This is what the "**LOCK?**" over Softkey 1 is asking you. You might want to reduce the **TLP** for some reason. Suppose you wanted to send at a 0 dB **TLP**. Just press **0** on the Numeric keypad and then **ENTER**. The display will change to:

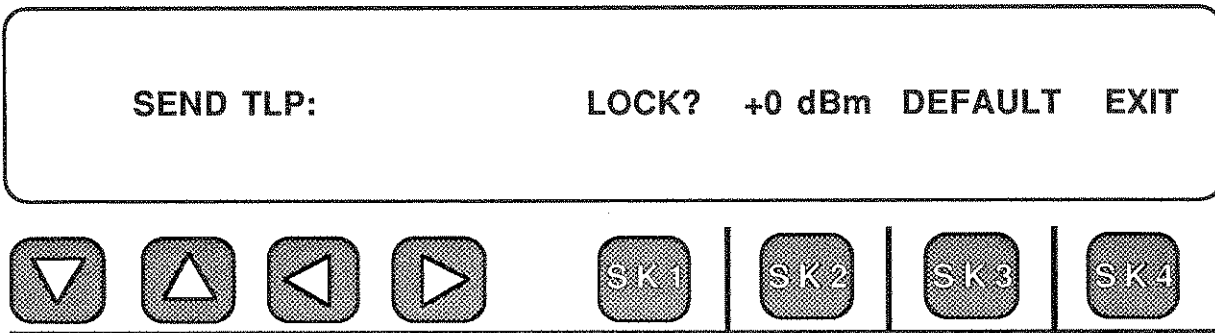

If you want this to be the new default value when you power up the 930A then press Softkey 1 and the display will indicate "**LOCKED.**" The 930A will alert you to the fact that the **TLP** is modified when you turn it on.

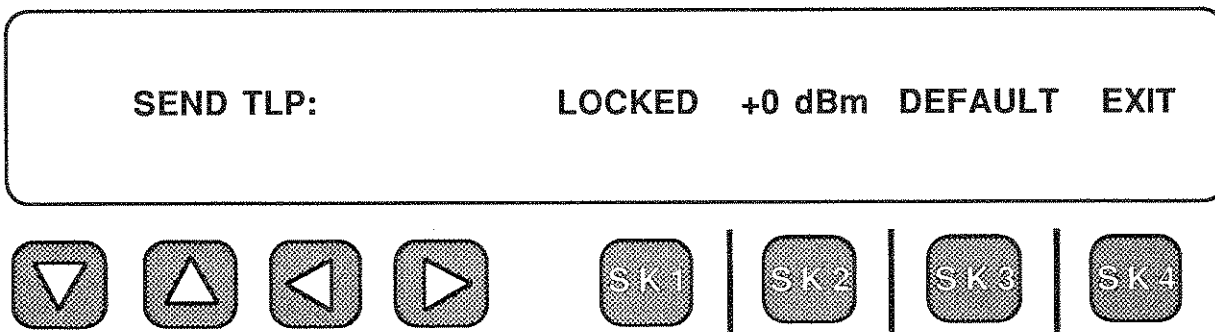

To return the 930A to the default **TLP** value for the Trunk Type selected, press Softkey 3 (under **DEFAULT**) and the 930A display will then show the appropriate value and unlock itself. Press Softkey 4 (under **EXIT**) to return to the **ADJUST** menu.

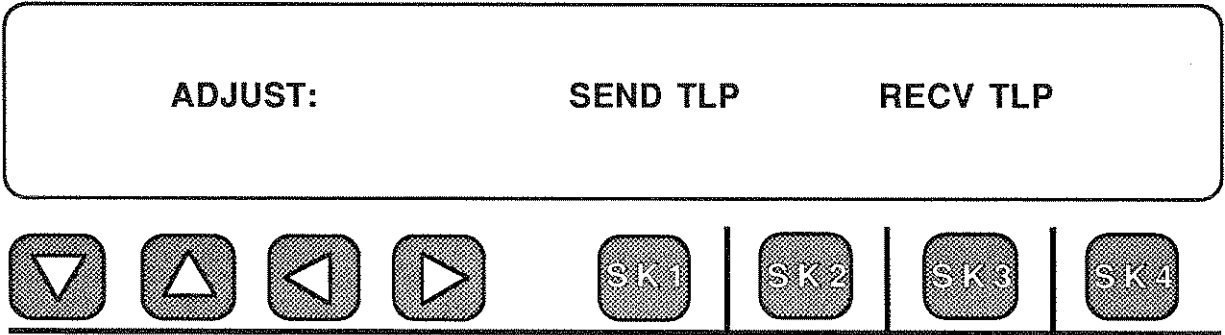

Changing the Receive TLP affects the level sensitivity of the 930A digit receiver. To change the **Receive TLP**, press Softkey 3 (under **RECV TLP**) and the display will become:

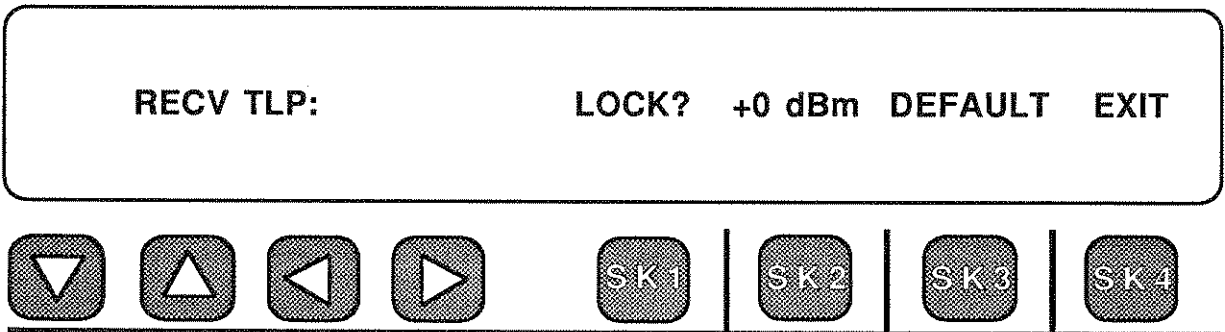



If the displayed **TLP** value (+0 dB in this example) is not what you want, just enter what you do want on the keypad and press **ENTER**. Just repeat the same procedure you used to change the **Send TLP**. The same is true for **LOCKing** in the default value, selecting the **DEFAULT**, or **EXITing**.

5-31 HOW TO SEND A HOOK FLASH (MENU OPTION 31)

Menu Option 31: **SEND HOOK FLASH** enables you to send a Hook Flash from the 930A. The length of the Hook Flash is nominally 200 milliseconds but is variable from 10 to 9999 milliseconds. This feature checks out a switch's, or PBX's, flash recognition capability.

To use this feature, perform the following steps:

Press the OPTION MENU  Option Menu function key.

Use the UP/DOWN   arrow keys to
select Menu Option 31: SEND HOOK FLASH.

The display will appear as shown below:

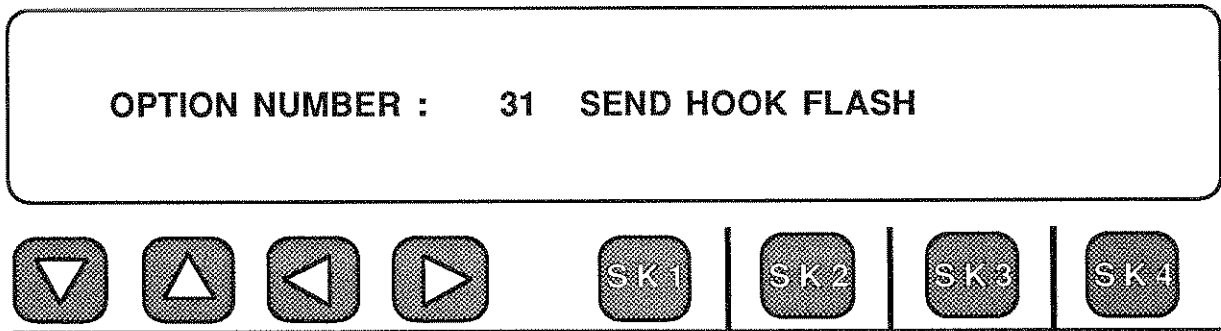

Pressing any softkey will bring up the main menu which is shown below:

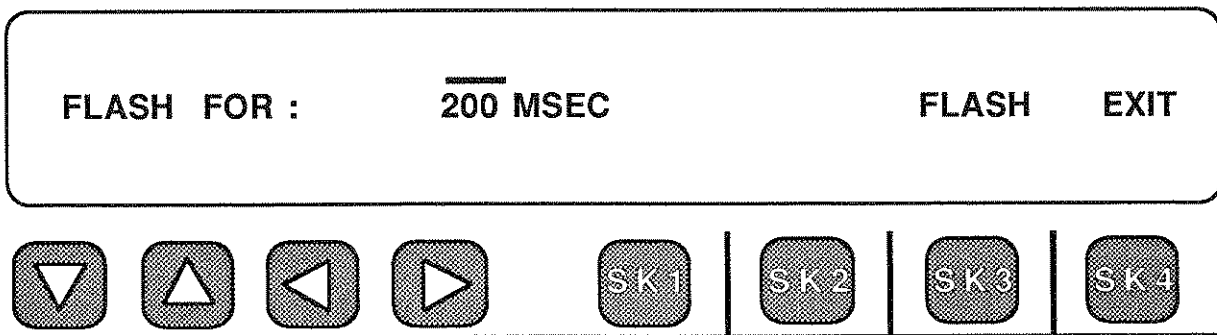

You can set any length flash you want from 10 milliseconds to 9999 milliseconds using the numeric keypad and the **ENTER** key. Bear in mind that very short duration flashes (< 50 msec.) will not be indicated by the front panel supervision LEDs.

To send a hook flash of the displayed duration, you press Softkey 3 (under **FLASH**):

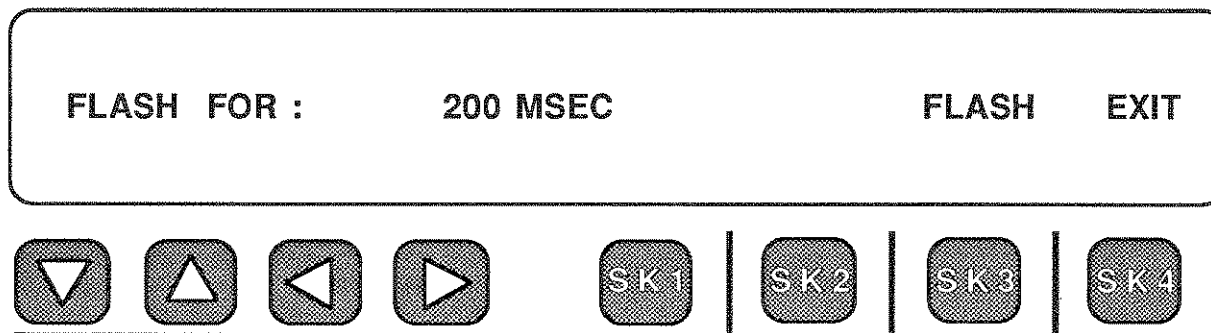

Pressing Softkey 3 would cause a 200 millisecond Hook Flash to be sent from the 930A on the analog trunk, or PCM channel (if Option 930A-08E or -09E is installed) selected. If the 930A is On Hook, pressing the **FLASH** softkey causes it to go Off Hook for the prescribed number of milliseconds. If the 930A is Off Hook, pressing the **FLASH** softkey causes the 930A to go On Hook during the flash.

To exit from this Menu Option, press Softkey 4 (under **EXIT**), or press the **OPTION MENU** key, and the display will return to:

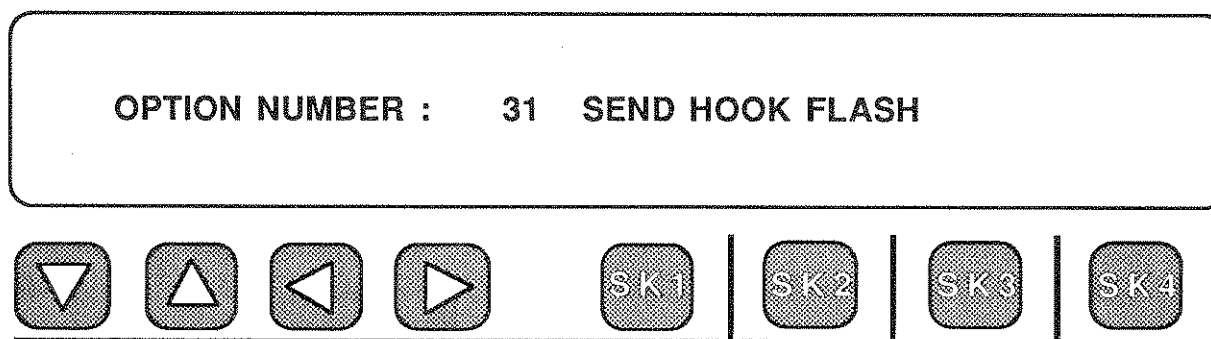

5-32 USING THE DIAL-UP TESTLINE (MENU OPTION 32)

Menu Option 32: **DIAL-UP TESTLINE** lets the 930A provide Quiet Termination or send a tone in response to ringing or seizure. That is, the 930A can act as a Type 100 or a Type 102 Testline. This function is particularly useful for connection appraisal testing through a switch. You may test any number of trunks through a switch to a 930A which is connected to a single port. You could dial through the switch on a thousand different phone numbers to reach the 930A tied to that single point. When each call completed, the 930A could be set to respond with a 1004 Hz tone at whatever level was preset.

To use this feature you first set-up what tone you want sent or "Quiet Termination" using the **SEND TONE** function. A commonly sent tone is 1004 Hz at a 0 dBm level to simulate the "Milliwatt." If you turn off the Send Tone function, the 930A will supply "Quiet Termination." After you have set-up the **SEND TONE** function perform the following steps:

Press the **OPTION MENU**  **Option Menu** function key.

Use the **UP/DOWN**   arrow keys to

select Menu Option 32: **DIAL-UP TESTLINE**.
TESTLINE.

The 930A display will appear as shown below:

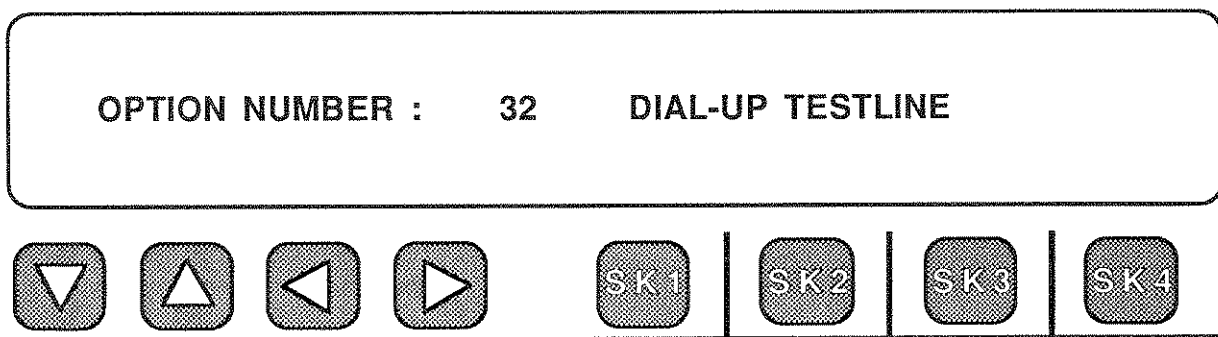

Press any softkey to enter the menu option and the display will become:

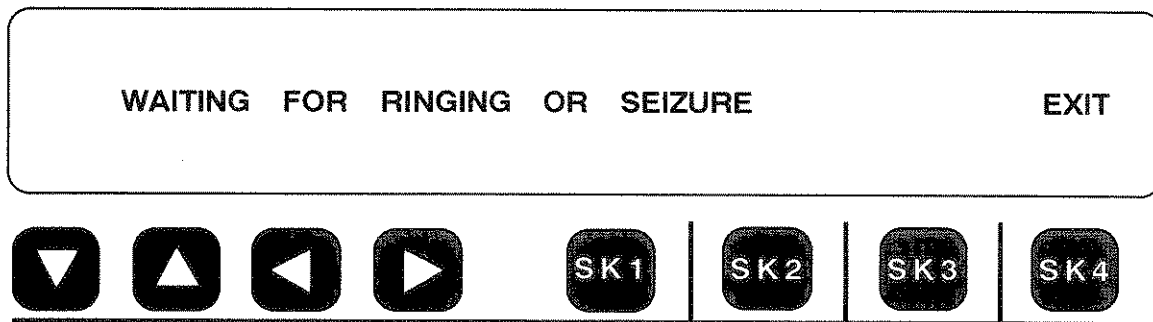

Entering this menu places the 930A On Hook where it will remain waiting for ringing or line seizure before going Off Hook.

If the 930A tone generator has been turned **OFF**, then the 930A will provide Quiet Termination when ringing or seizure is detected.

If you have selected a particular tone, say 1004 Hz at 0 dBm, and left the tone generator turned **ON** prior to entering Menu Option 32, then the 930A will respond with the 1004 Hz at 0 dBm when ringing or seizure is detected.

This feature would be used mainly on Loop Start Trunk Types where the 930A is simulating the **CONTACT** side of the trunk but it could be used on any Trunk Type.



This page intentionally left blank.

5-33 USING THE DIAL-UP SWEEP (MENU OPTION 33)

This standard feature operates exactly like the **DIAL-UP TESTLINE** function except that it sends back whatever Sweep parameters have been set in Menu Option 10: **FREQUENCY SWEEP**. This is particularly useful when you want to make an attenuation distortion measurement on a 2-wire trunk and there is no one available to test with you at the far-end. A 930A at the far-end can be set to send you whatever sweep parameters you want whenever you call it up.

To use this feature you first set the sweep up using Menu Option 10. The 930A default sweep is the one most often used for attenuation distortion measurement, so normally you do not need to do this unless you have changed the factory defaults. **Next**, you do the following:

Press the OPTION MENU  Option Menu function key.

Use the UP/DOWN   arrow keys to select Menu Option 33: DIAL-UP SWEEP.

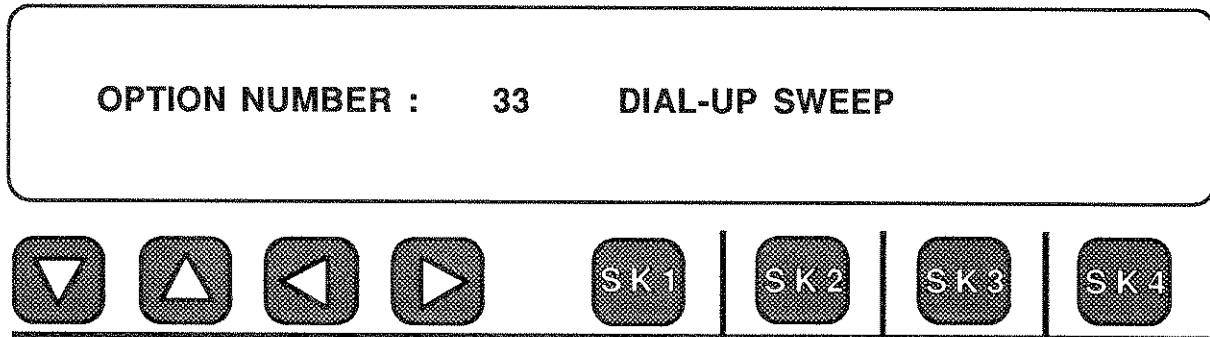

Enter the menu by pressing any of the softkeys below the display and you will see:

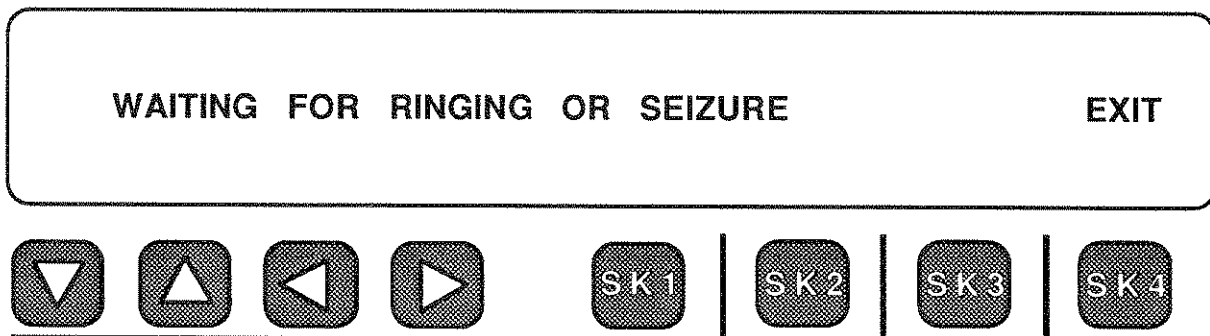



When the 930A receives ringing, or sees a seizure on the trunk, it will begin sending the sweep frequencies back. This will continue until the trunk is disconnected (goes back On Hook). The 930A will do this as long as it is left in this menu.

Pressing Softkey 4 will **EXIT** from the menu and stop any sweep in progress.

5-35 SENDING DIAL-TONE, BUSY AND OTHER DUAL TONE SIGNALS (MENU OPTION 35)

The 930A is capable of sending any dual tone signal whose two tones fall within the 930A frequency range. For the convenience of the user, the 930A has several preset signals. These are Dial-Tone, Busy and Reorder. But you can input any two tones you wish and set their levels and their on and off times as well. The following steps outline the procedure for using this menu option.

Press the OPTION MENU   Option Menu function key.

Use the UP/DOWN   arrow keys to select Menu Option 35: DUAL TONE SENDER.

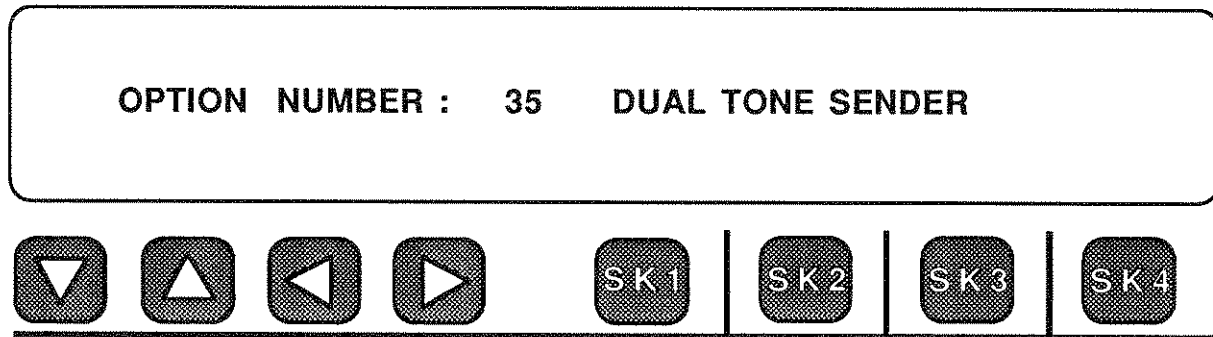

Press any softkey and the main SELECT display will appear.

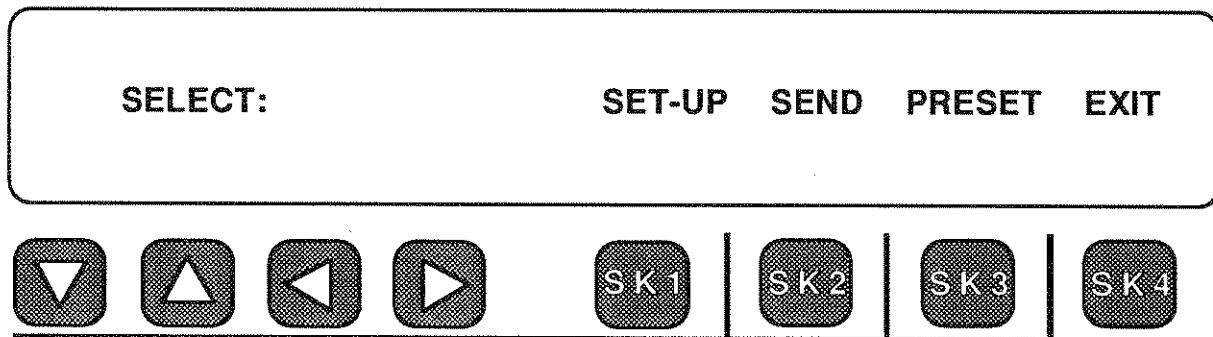

To select and send a standard preset signal such as Dial Tone, Busy or Reorder press Softkey 3 under PRESET. The display becomes:

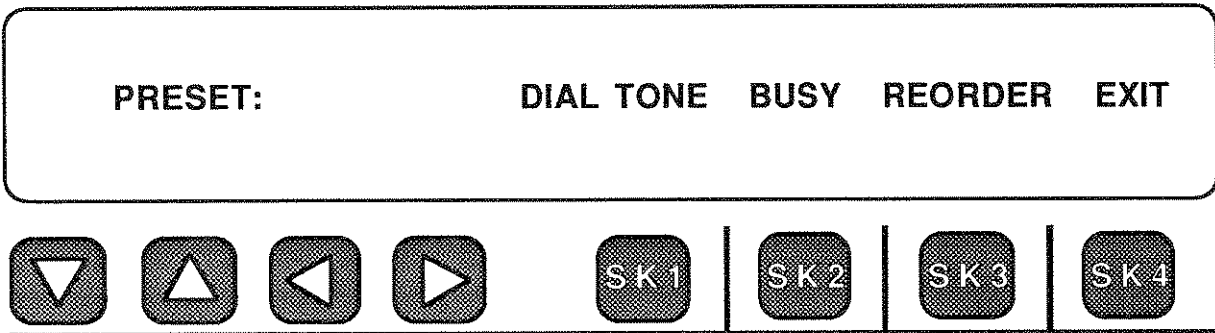

Make your selection by pressing the softkey directly below the tones you want to send. For instance, pressing Softkey 2 under BUSY will select the trunk busy signal. Once you have made your selection you will be returned to the main SELECT menu.

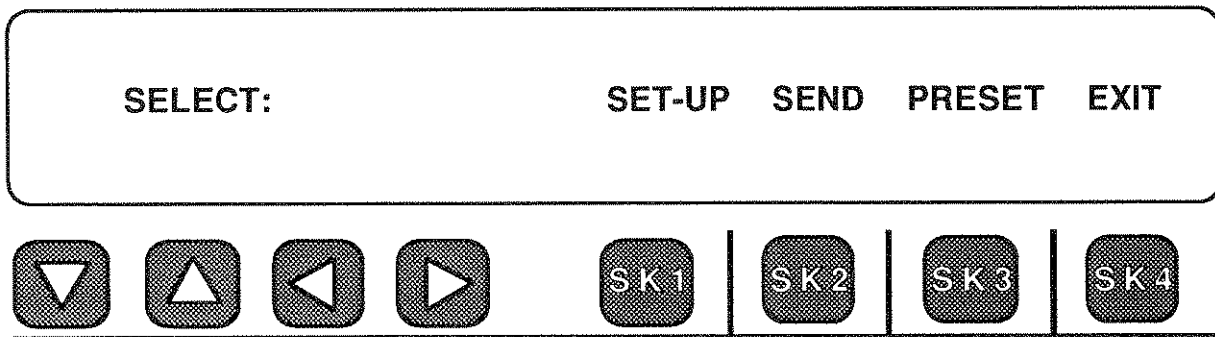

At this point, press Softkey 2 under SEND to begin sending the tones you selected. A flashing cursor will appear over SEND while you are transmitting. To stop sending, press Softkey 2 again or press Softkey 4 under EXIT.

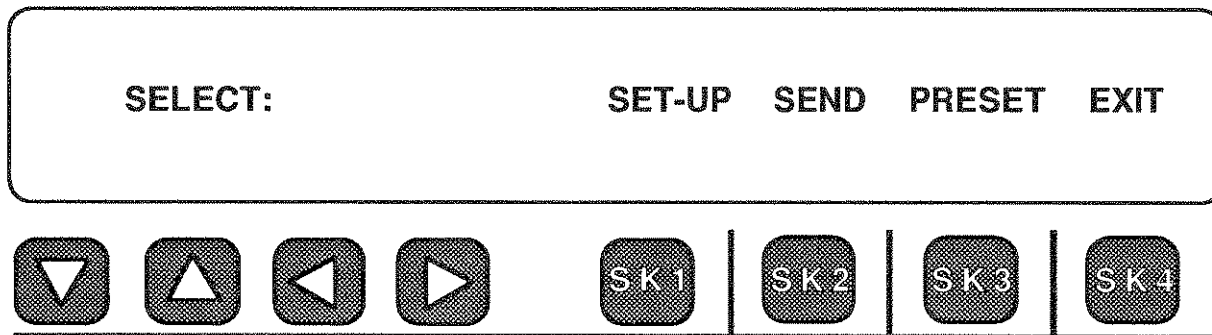

To send a two tone signal other than the PRESET tones, use the SET-UP menu. Press Softkey 1 to enter the SET-UP display.

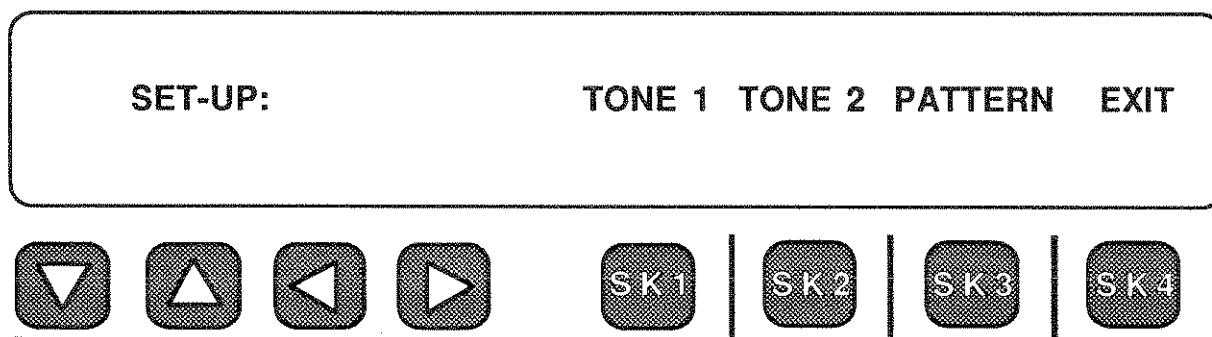

Begin by setting the level and frequency of TONE 1. To do this, press Softkey 1 under TONE 1. A display similar to the following will appear:

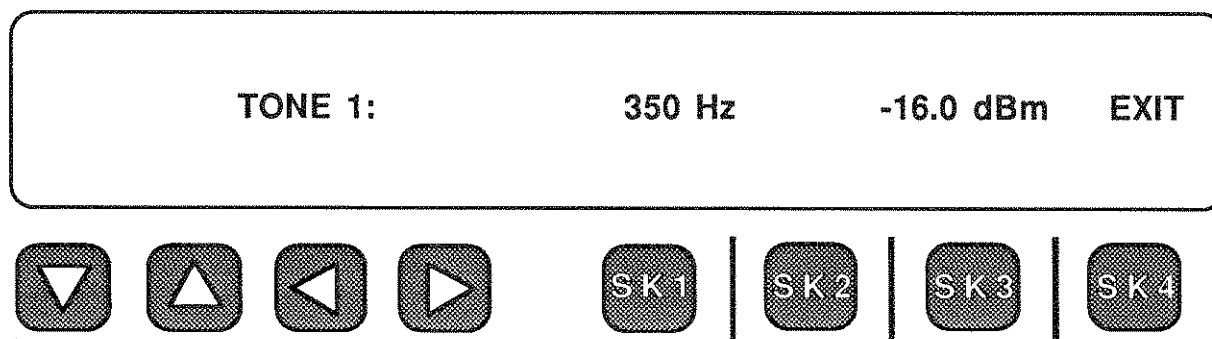

To change the frequency of the tone press Softkey 1 (under 350 Hz in this example) and then enter the desired frequency from the keypad. Press the ENTER key to complete the selection.

To change the level of the tone press Softkey 3 (under -16.0 dBm in this example) and then enter the desired level from the keypad. Press the ENTER key to complete the selection. Press Softkey 4 under EXIT to return to the main set-up menu.

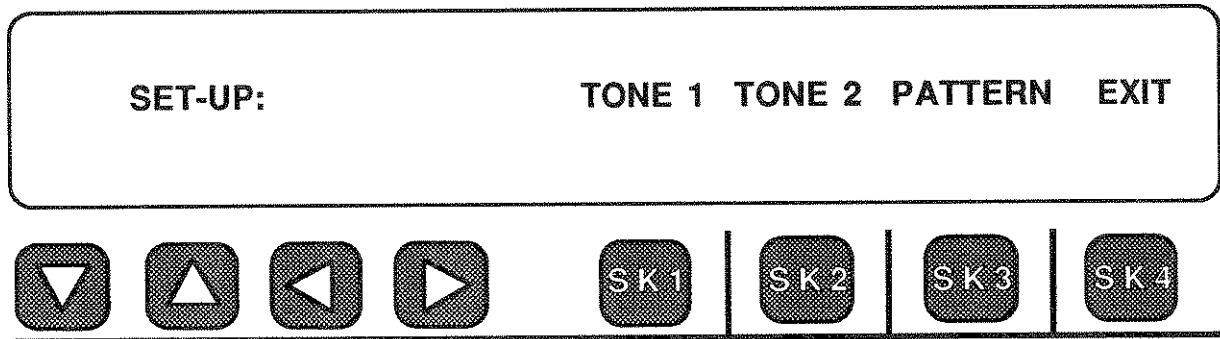

To change the level and frequency of TONE 2 press Softkey 2 and a display like the one below will appear.

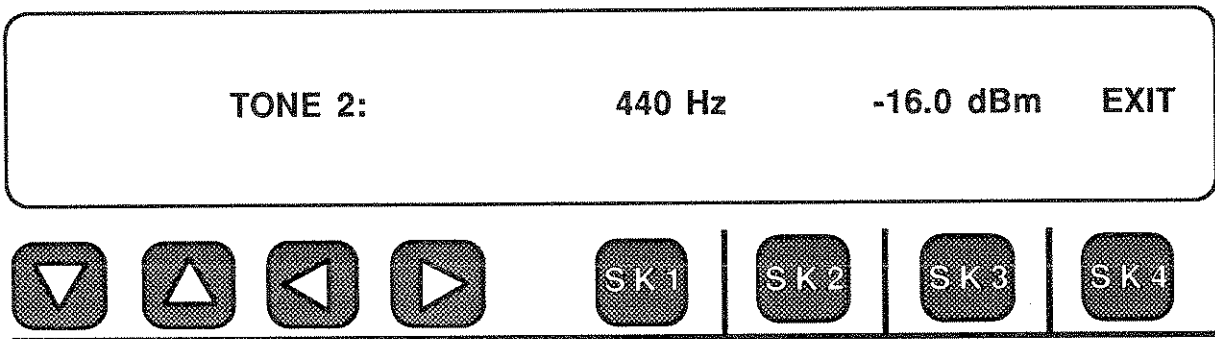

Repeat the procedure previously outlined for TONE 1 to modify TONE 2. When you have set TONE 2, press Softkey 4 to exit back to the SET-UP menu.

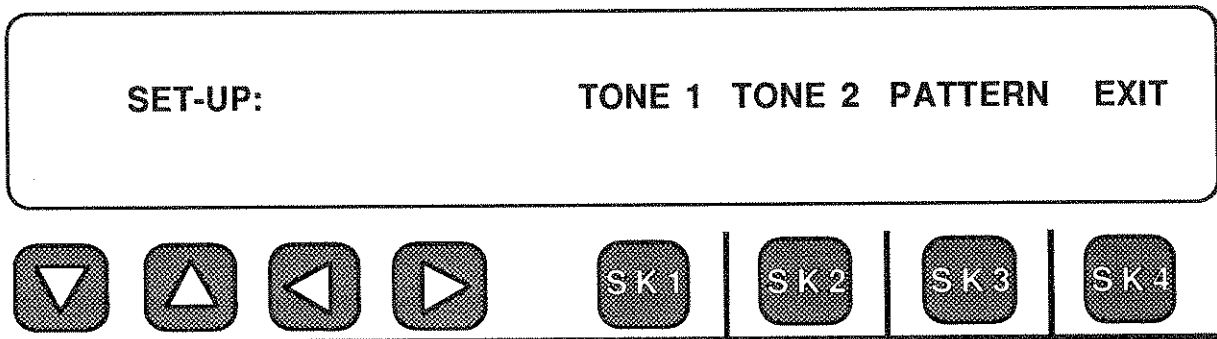

You are now ready to change the timing or pattern of the dual tone signal.

To change the Pattern, press Softkey 3 under PATTERN and the display will change to:

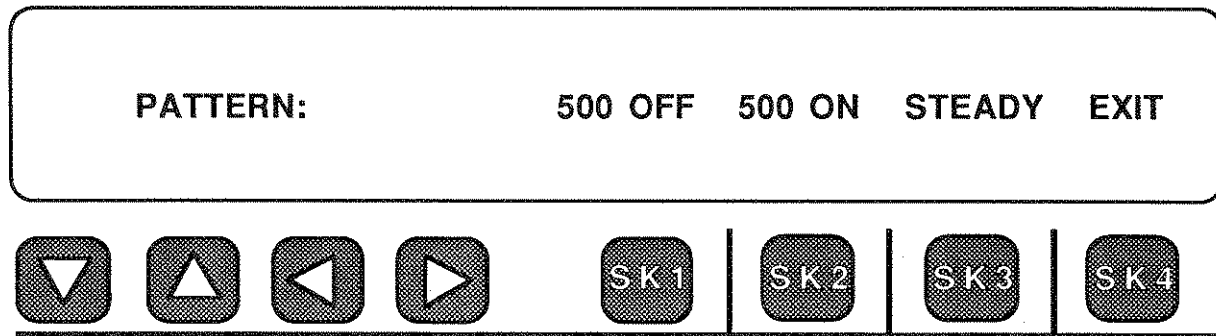

You can set the time your tones will be on and off or you can have them transmit steadily. For example, Dial Tone is sent continuously or STEADY. Busy is sent at 0.5 seconds ON and 0.5 seconds OFF as shown above. The display shows time in milliseconds so 0.5 seconds is shown as 500 milliseconds.

To change the ON and OFF times, press Softkey 1 under OFF and enter the desired time using the keypad and then press Softkey 2 under ON to change the on time.

To send a signal continuously, press Softkey 3 under STEADY and then press Softkey 2 under SEND in the SELECT menu. Notice that in this case the ON and OFF times are blank.

When you have made your selections, press Softkey 4 to exit.

To send your creation, press Softkey 2 under SEND in the SELECT menu just as you did for PRESET tones.

5-37 LINE STATUS (MENU OPTION 37)

The Line Status feature allows the user to Bridge or Terminate on a Metallic facility (2/4W) Loop or a PCM Channel and Monitor the status of the line in one direction. Typically, it analyzes the received audible tones on the line and displays the condition. The following audible tones are analyzed:

- Dialtone
- Busy
- Reorder
- Dead Line
- Ringing
- Talking or Speech
- Tone

When any of the above conditions occur, it will display the particular condition in realtime. If the condition changes, it will clear after a timeout and indicate the new condition. This information can be printed as a record on a printer as it occurs.

5-37.1 OPERATIONAL PROCEDURES.

To start operation, Press **OPTION MENU**. Enter **37** from the Keypad and press **ENTER**. The following screen will be displayed:

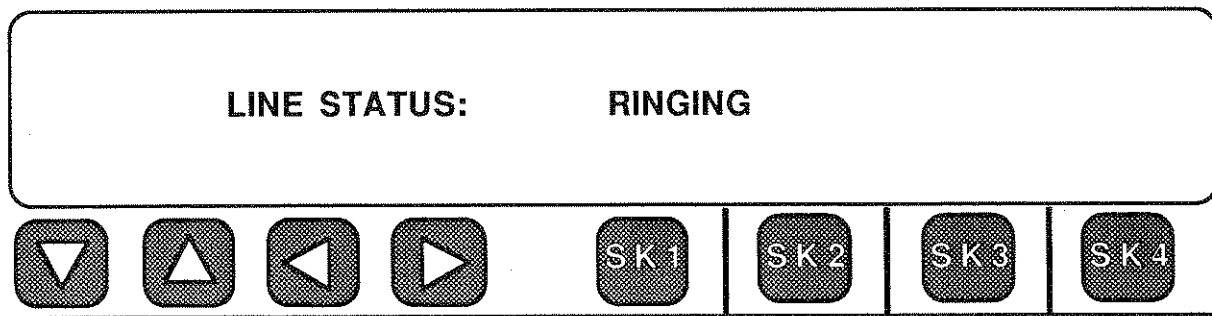

As conditions change on the line, the screen status will update. This continues until you decide to exit. Press **OPTION MENU** when the test is complete.

5-39 REMOTE AUDIO MONITOR (930A-47)

5-39.1 INTRODUCTION

When installed, Option 930A-47 (Remote Audio Monitor) provides the user with remote access to the VF information on the trunk under test. This is accomplished via a separate dial-up auto answer or originate dial-up line. This enables troubleshooting and verification from a remote location.

Remote audio access is through a standard modular telephone jack (Type RJ-11) located on the lower left of the 930A Rear panel. The modular jack provides a loop appearance, and can be set to auto answer or to dial out over any public switched telephone line. When the 930A is turned on, the remote audio line is placed ON-Hook. The Monitor can be set to automatically answer when it detects ringing, or can be set to ignore incoming calls for security purposes and to manually originate a call through Dial/Ring.

The following steps describe the setup and operation of the 930A with Option 930A-47 installed.

Press the Option Menu key. Use the **UP/DOWN** arrow keys to select Menu Option 39: **REMOTE AUDIO**. The following screen is displayed:

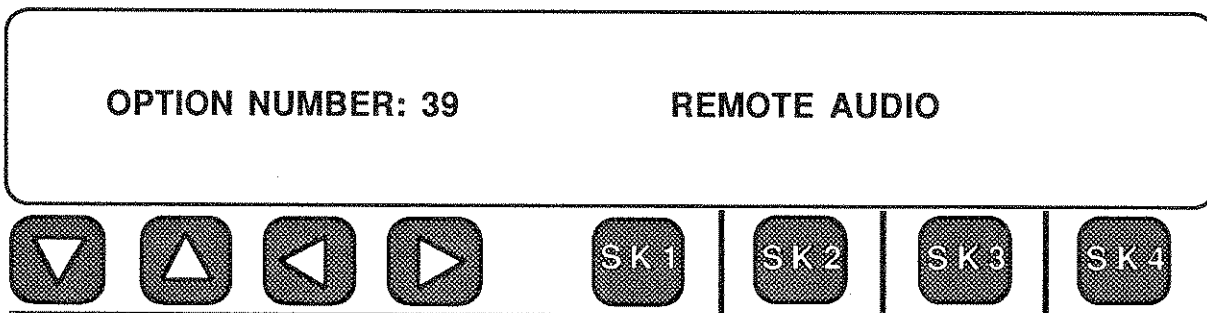

Pressing any Softkey will enter the function and the display will appear as shown below:

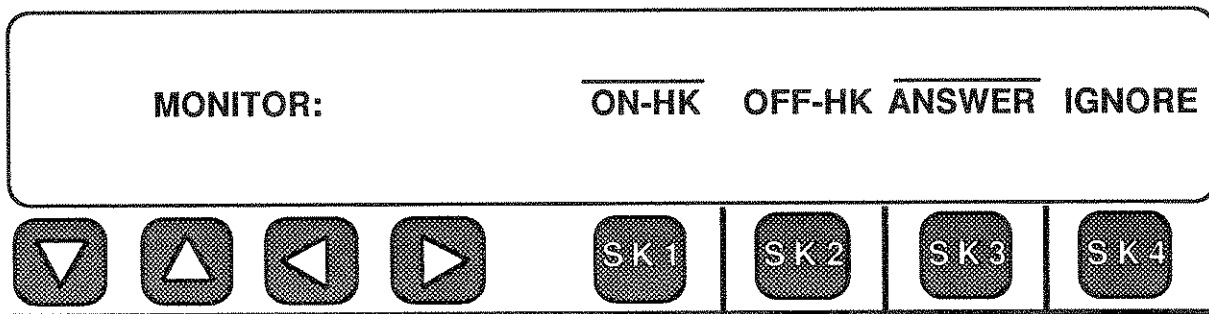

There will be flashing cursors to indicate whether the audio monitor is currently **ON** or **OFF-HOOK**, and whether it has been programmed to answer or ignore incoming calls. In the above example, the remote audio line is On-Hook and ready to answer incoming calls.

If the remote line has been set to answer incoming calls, it will respond to ringing by going Off-Hook.

When the remote line is Off-Hook, the sounds normally heard over the 930A's speaker are those transmitted over the remote line under test and are audible to the operator at the remote location via the dial-up telephone line and handset.

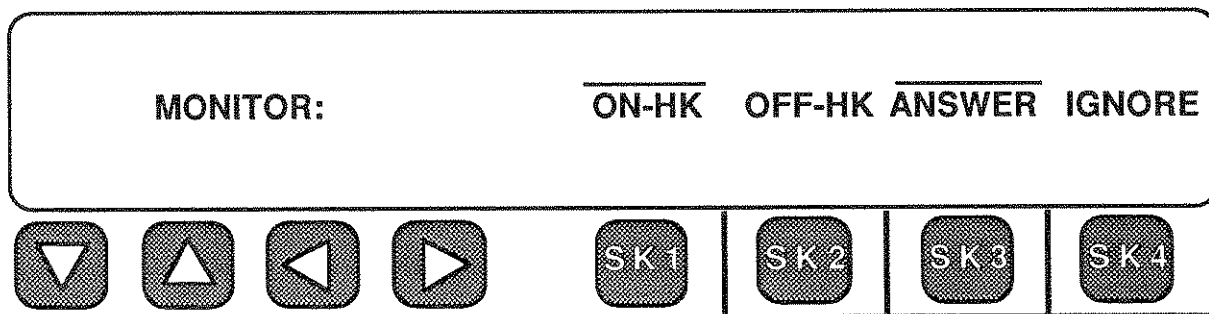

CONTROL KEYSTROKES:

Press (SK1) to place the remote line ON-Hook.

Press (SK2) to place the Remote Line Off-Hook.

Press (SK3) to answer incoming calls.

Press (SK4) to ignore incoming calls.

Press the Option Menu key to exit.

NOTE: These softkey strokes can be operated remotely by establishing a modem call connection from the control site. Use standard **TERMINAL** keystrokes using **930A MENU OPTION 3** to setup.

If (SK2) has been pressed, the 930A display will change to:

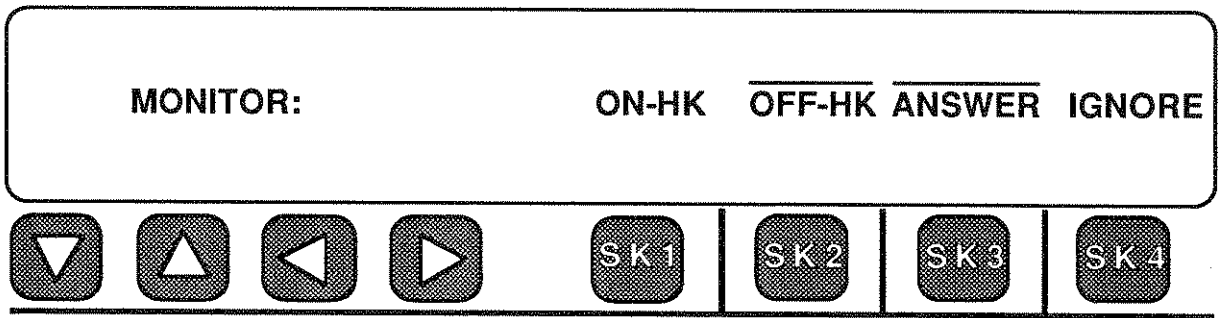

The connection of the 930A for remote audio operation appears below:

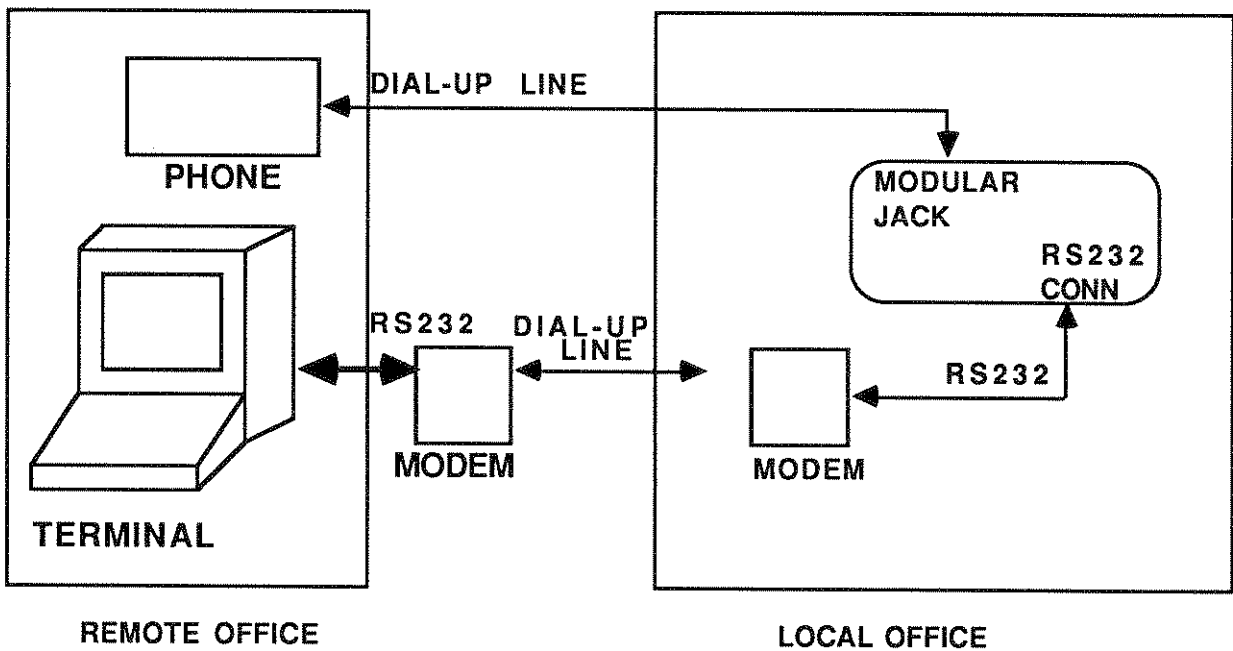

FIGURE 5-9
REMOTE AUDIO OPERATION

5-39.2 SETUP PROCEDURES

To dial out on the remote audio line, place the 930A in a Monitor mode. Bridge on Analog, MON1&2 or THRU on PCM so that its output will not affect the trunk under test. Take the remote audio line Off-Hook through Option Menu 39 as previously described.

Press the **Dial/Ring** function key and select DTMF outpulsing. Outpulse the telephone number of the remote operator's speakerphone. When the connection has been established, the operator may then put the 930A back into an active Non-Monitor testing mode.

When the Remote Audio connection has been established, the remote operator may converse over the trunk under test. The remote operator may also converse with the local operator through the 930A, placing the 930A in Dial/Ring mode and having the local operator plug in a handset into the headset jacks.

**5-40 HOW TO SEND PCM ALARMS AND FORCE FRAME SLIPS
(MENU OPTION 40)**

Sending Remote Alarm, Blue Alarm or forcing a Frame Slip is obviously not intended to be done on spans carrying service. They are tests usually performed prior to turning up service on a channel bank or switch to see that their alarm indicators are working. The 930A will not allow you to send alarms or slips unless you are in the TERMINATE mode (out of service).

You connect your 930A as shown below and set it into the **TERMINATE** mode.

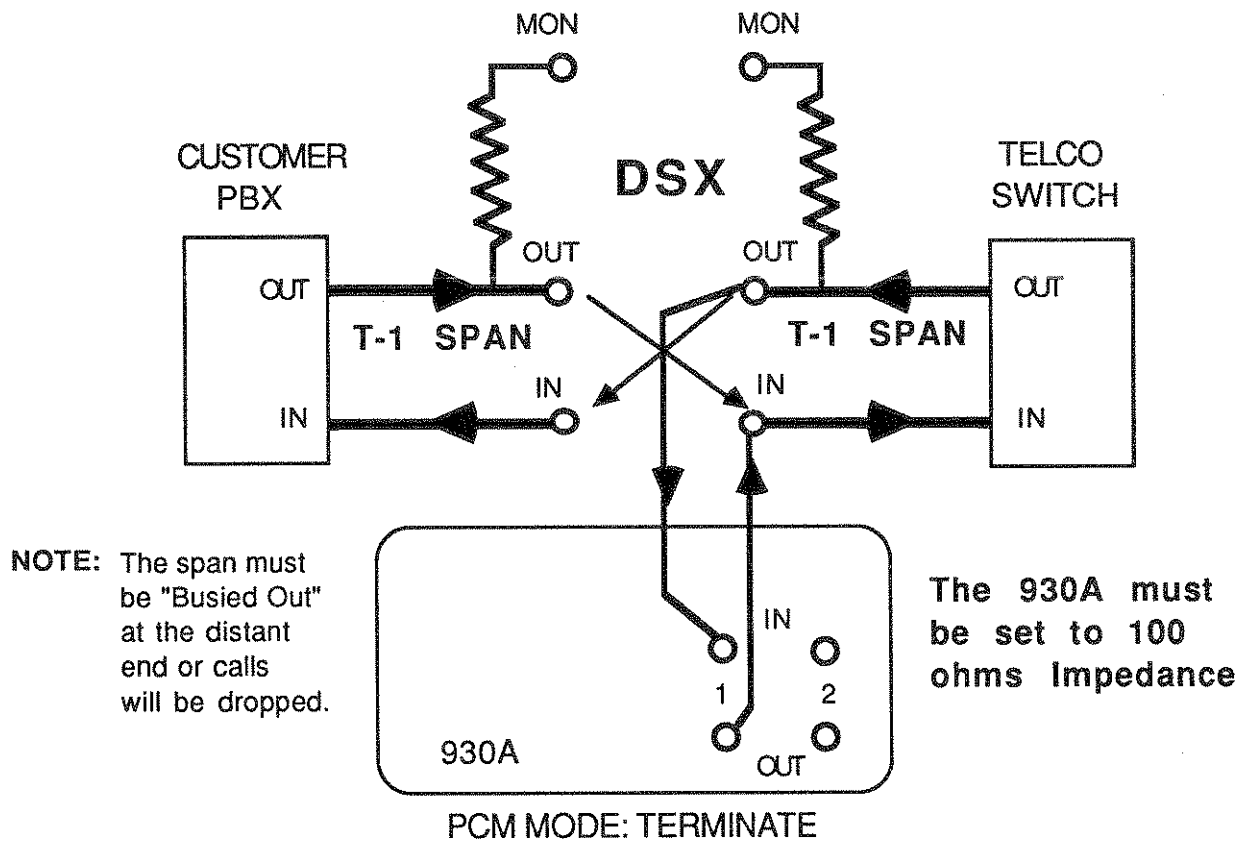



**SENDING ALARMS OR FORCING SLIPS FROM THE 930A
FIGURE 5-10**

You may try to force a frame slip toward the distant end of your circuit to see if it is loop-timed. If it is loop-timed, you will not be able to force a slip toward it. You may want to send Remote (or Yellow) Alarm toward a channel bank to see what it does, or you could send the Blue Alarm (all 1's) unframed. These are useful tests, but not when you have service on a span.

To send alarms, or force slips, do the following:

Press the OPTION MENU  Option Menu function key.

Use the UP/DOWN   arrow keys to get to Menu Option 40: **SEND PCM ALARMS.**

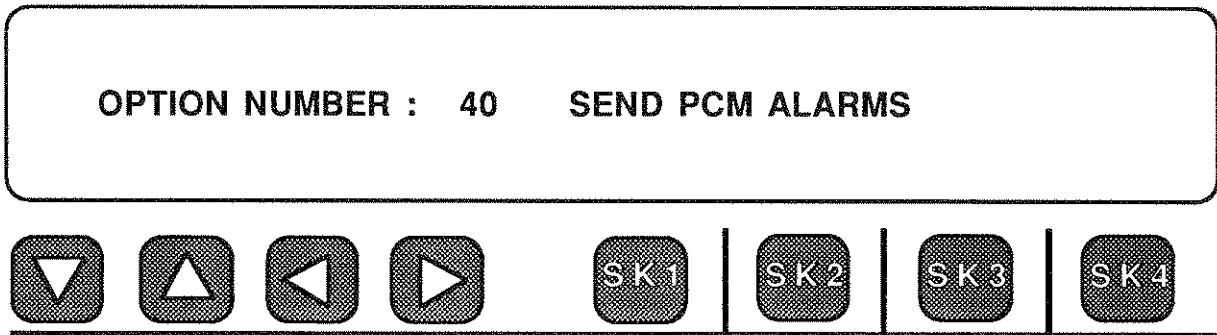

Press any softkey under the display to get into the main menu.

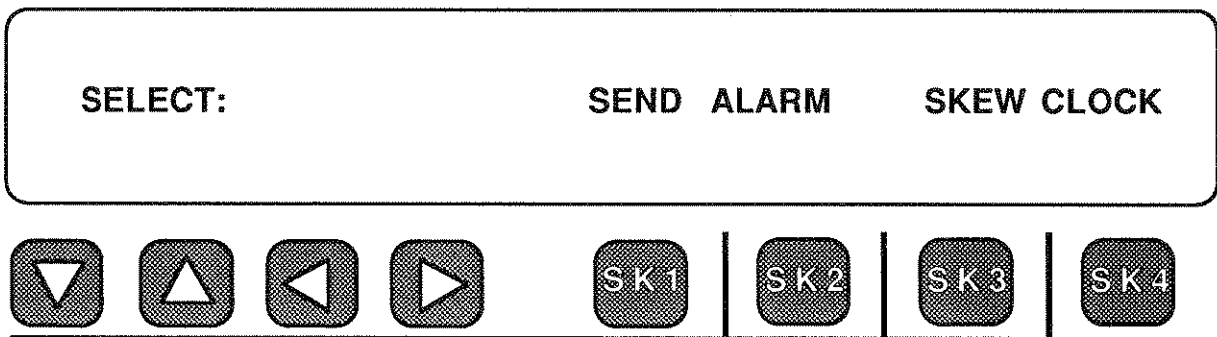

To send an Alarm, press Softkey 1 or 2 and the Alarm display will appear.

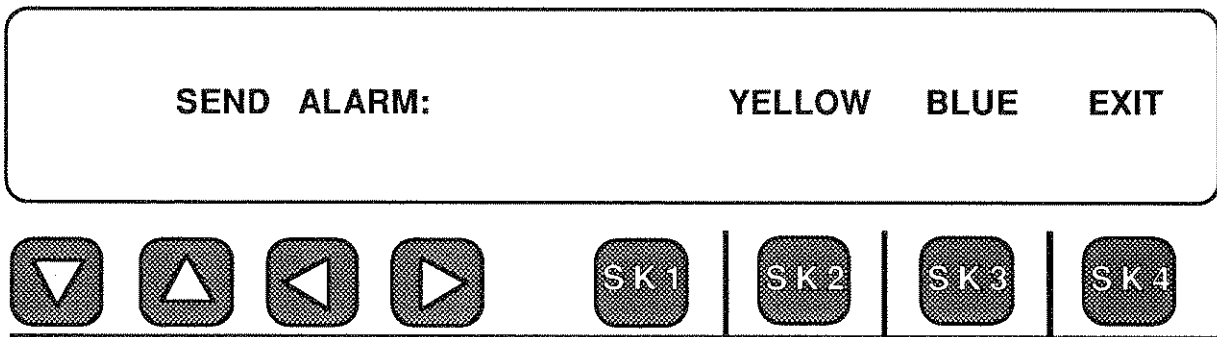

Press Softkey 2 to send the Remote, (Yellow) Alarm (on D4 and SLC-96, bit number 2 is forced to 0 on all 24 channels; on ESF, a special code is sent over the Facility Data Link). Press Softkey 3 to send the Blue Alarm (All 1's). When you select an alarm, a cursor appears over your selection as shown below for the example of a Yellow Alarm:

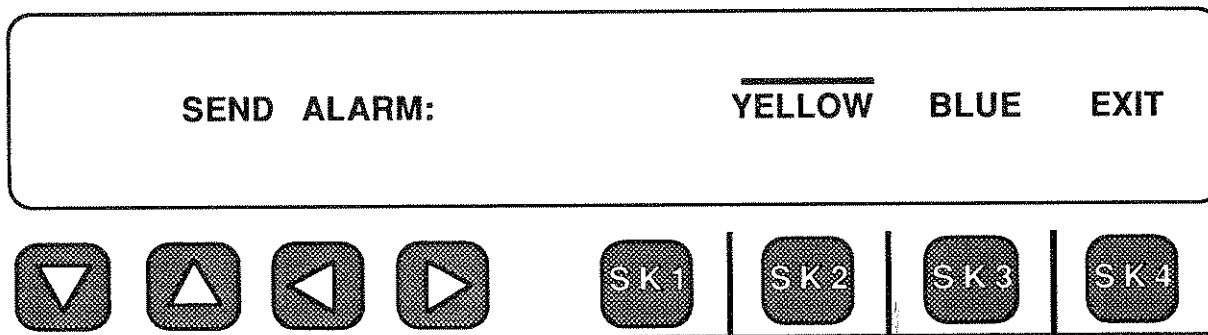

When you exit from this menu the alarm is turned off.

To force a slip, the 930A must be supplying the clock to the circuit (INT CLK) and then you can offset or skew the clock.

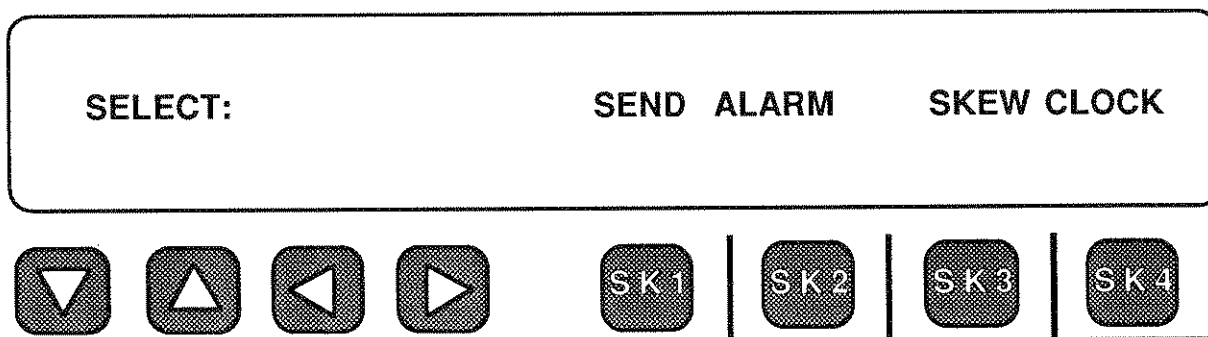

Press Softkey 3 or 4; if the 930A is set to Internal Clock the normal 1.544 MHz clock will be offset by 100 Hz. **This is enough to force frame slips to occur if the distant end of the circuit is not Loop-Timed.**

While you are skewing the clock, the display will look like:

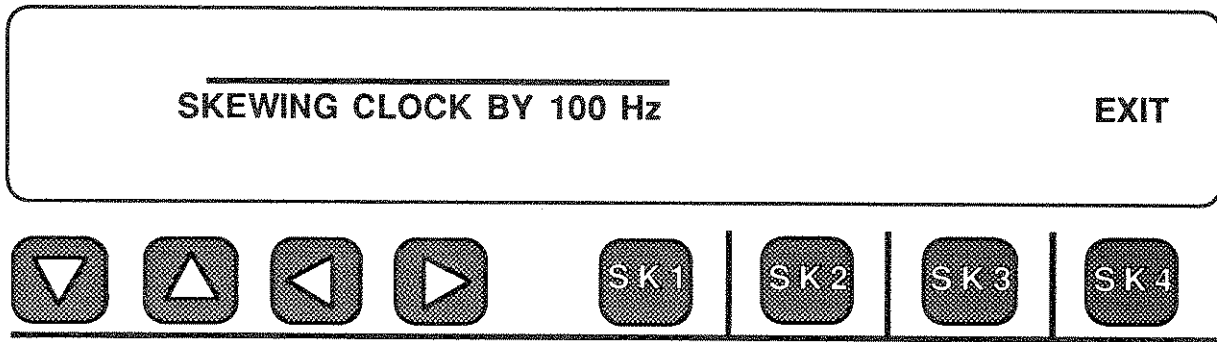

Note: When skew is set properly and the far end is not loop timed, a slip will occur every 2-3 seconds.

When you exit the menu, you return to the normal clock. Slips, if they occur will be detected while you are in this menu and the display will be interrupted momentarily to indicate slips are occurring. The Slip Counter in Menu Option 43 will also be counting the slips.

5-41 HOW TO MEASURE THE T-1 VOLTAGE AT THE DSX JACKS (MENU OPTION 41)

To measure the positive and negative base-to-peak voltages, connect one, or both, of the PCM receivers to the DSX. For example, take the case of a 930A in the MON-1 mode connected to the monitor jack on a DSX.

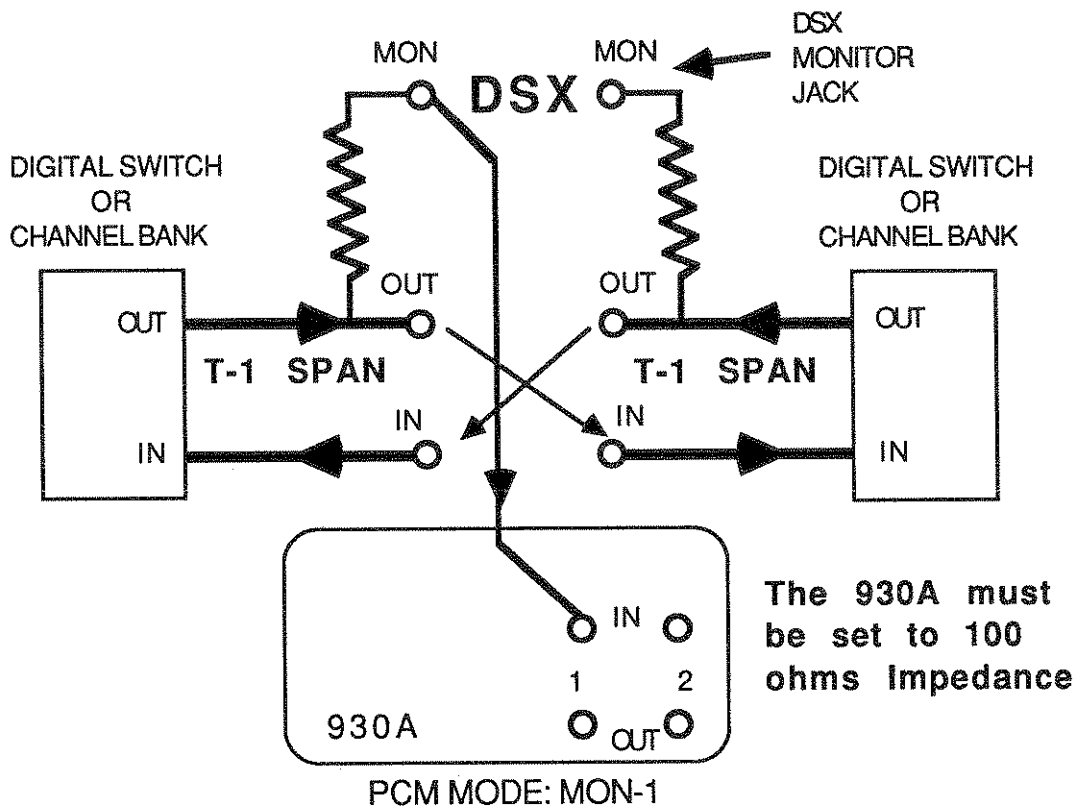

MEASURING T-1 VOLTAGE AT THE DSX MONITOR JACK FIGURE 5-11

You should know what voltages are expected at this point to make sense out of the readings. For instance, if you plugged into the DSX output jacks, you would expect to see about ± 3.0 Volts base-to-peak. At the monitor jacks, however, you should expect to see about one tenth the voltage, or roughly ± 0.3 volts base-to-peak. You should not read less than ± 0.2 volts base-to-peak at the DSX Monitor jack. If you do, this indicates a possible problem on the span. It could be a problem with a repeater, a defective cable, poor equalization, or too long a cable run from the equipment to the DSX.

You measure the voltage on the 930A from Menu Option Number 41: **READ T-1 VOLTAGE** after you have set the PCM Trunk Type and connected the test cords to the DSX.

Press the OPTION MENU  Option Menu function key.

Use the UP/DOWN   arrow keys to

get to **Menu Option 41: READ T-1 VOLTAGE.**

Press any softkey to get into the main menu and the 930A will display its readings as Base-to-Peak voltage. An example of a typical reading at the **DSX Monitor** jack is shown below.

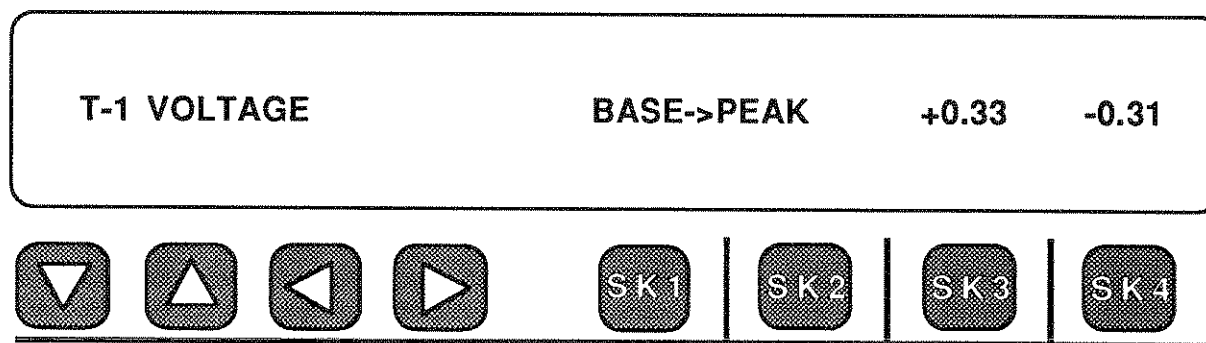

This is about what you would expect, give or take a tenth of a volt. You would expect problems if these readings were below ± 0.2 Volt. That might indicate that you had cable runs in excess of the **DSX** limitations. Then you might have to put your signal through a bridging repeater first.

If you were to measure the voltage **directly at the DSX output**, then you would see a display that would look more like the one below.

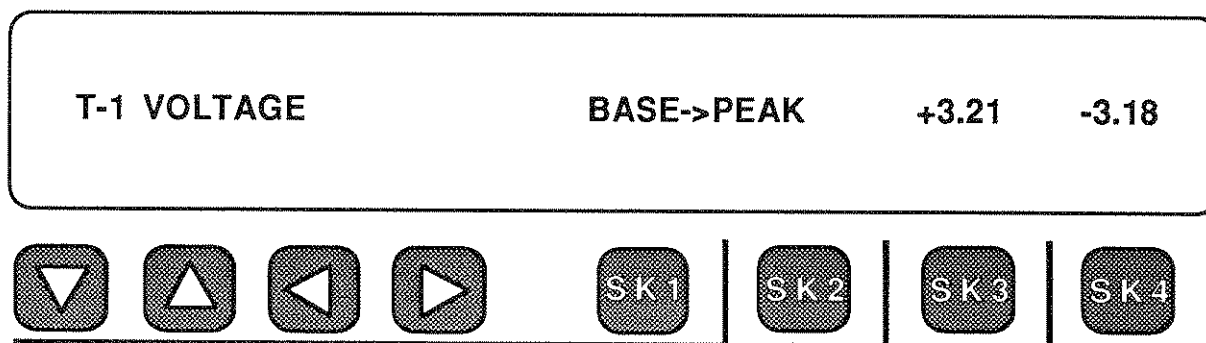

You can see from this that the positive and negative going peaks are close to each other in terms of absolute value. If they were very different from each other (more than 0.5 Volt), or if they were much higher or lower than the nominal 3 Volts (say ± 6.0 Volts), you would expect to have problems.

To read the T-1 pulse amplitude in dBdsx instead of voltage, press any softkey under the display and the display will become:

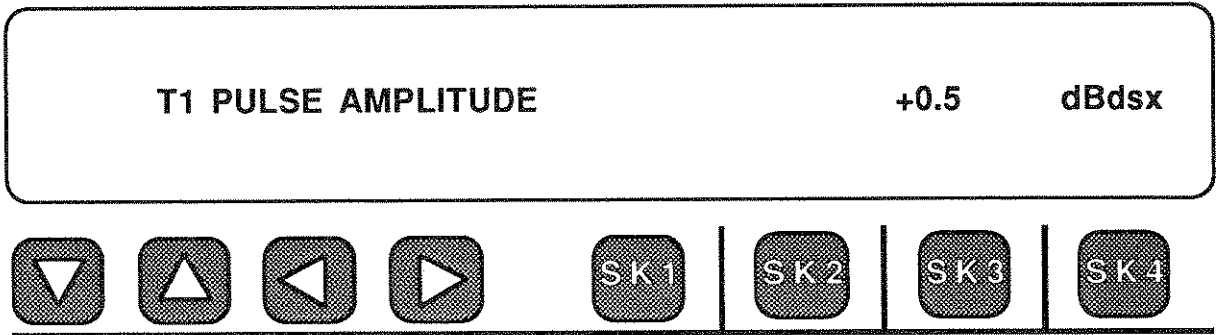



3.0 Volts base-to-peak is equal to 0.0 dBdsx. Readings between 0 and 1 dBdsx would be expected at the DSX output jacks. Readings of about -20 dBdsx would be expected at the DSX Monitor jacks.

**5-42 HOW TO DETECT T-1 WANDER OR CLOCK DIFFERENCE
(MENU OPTION 42)**

T-1 Wander, sometimes called Bit Slips, is what you have prior to a Frame Slip. You can use Menu Option 42: T-1 WANDER to get an indication of whether or not a span may have a slip problem. This Menu Option is best used with the 930A in the **MON-1&2** mode so you can compare the outgoing and incoming clocks. **After you set-up the PCM Trunk Type**, do the following:

Press the OPTION MENU   Option Menu function key.

Use the UP/DOWN   arrow keys to get to Menu Option 42: T-1 WANDER.

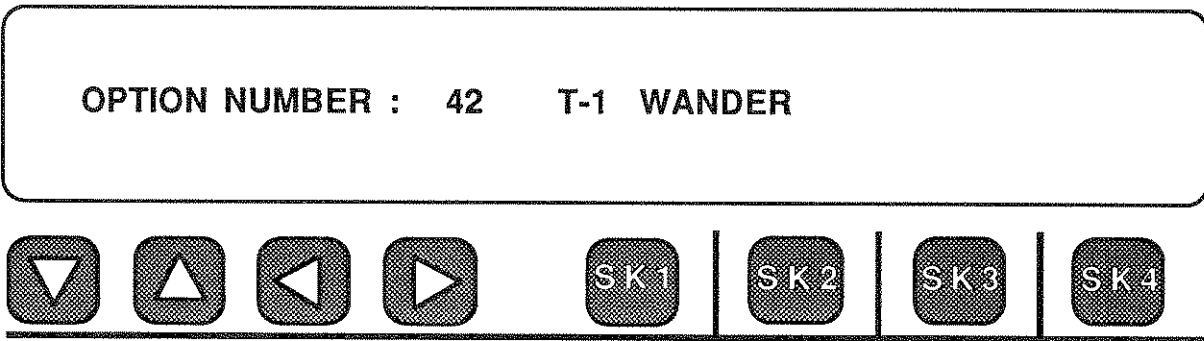

Press any softkey under the display and the 930A starts measuring. If you have the 930A connected as shown below, you will compare the clock on the two sides of the span.

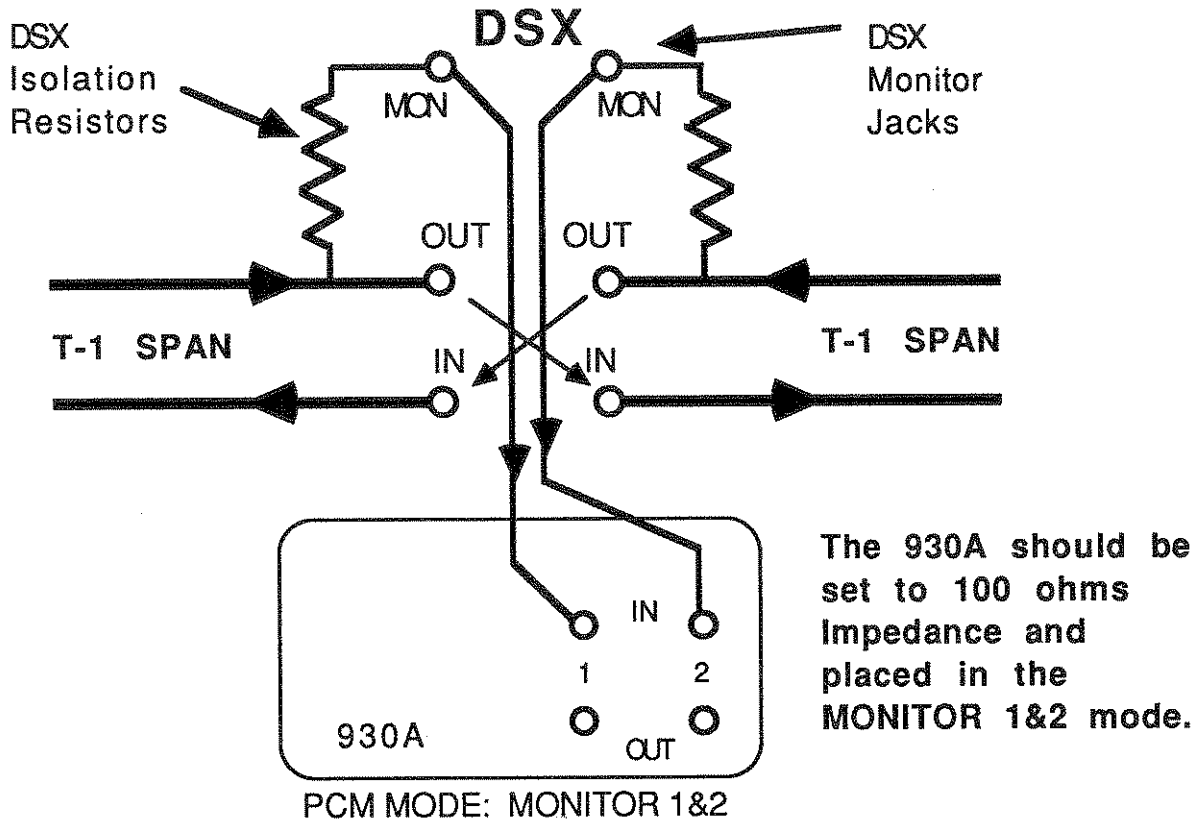

**930A CONNECTED FOR WANDER MEASUREMENT
FIGURE 5-12**

If you are Loop-Timed, and your clock is good, the display will be:

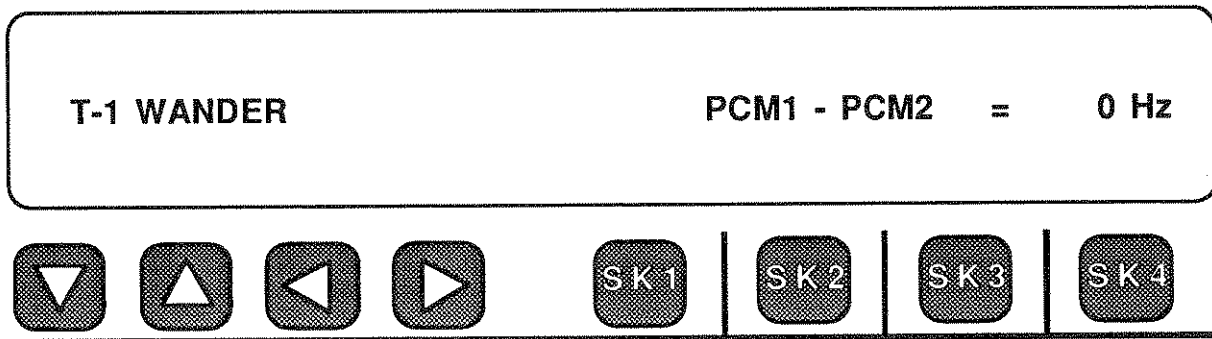

This frequency difference between bit streams is also called the Bit-Slip rate (gated rate for 1 second). 193 Bit-Slips = 1 Frame Slip.

If you are not Loop-Timed, you might see a display like:

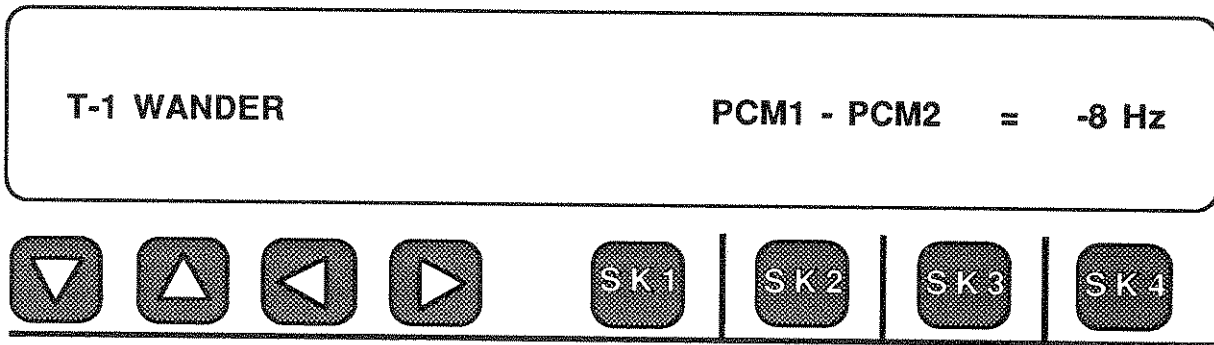

In this case, bit slips will occur and the two sides may diverge until a frame slip occurs. This could be in either the + or - direction. If you connect the 930A's **PCM IN 1** jack to a known good clock, then you can connect **PCM IN 2** to the suspect side of the span and see if it is different. You should stay connected to the **DSX Monitor** jacks.

You can also use this Menu Option with the 930A in the **MON-1** or **TERMINATE** modes. In this case the 930A compares the clock on **PCM IN 1** to its own Internal Clock. **Be aware that if you are in the TERMINATE mode and on EXT CLK (Loop Timed), going to this Menu Option will cause the 930A to temporarily change to INTERNAL CLOCK. When you EXIT from this menu, the 930A returns to EXT CLK.**

A typical display of wander, when you are in a single direction mode is:

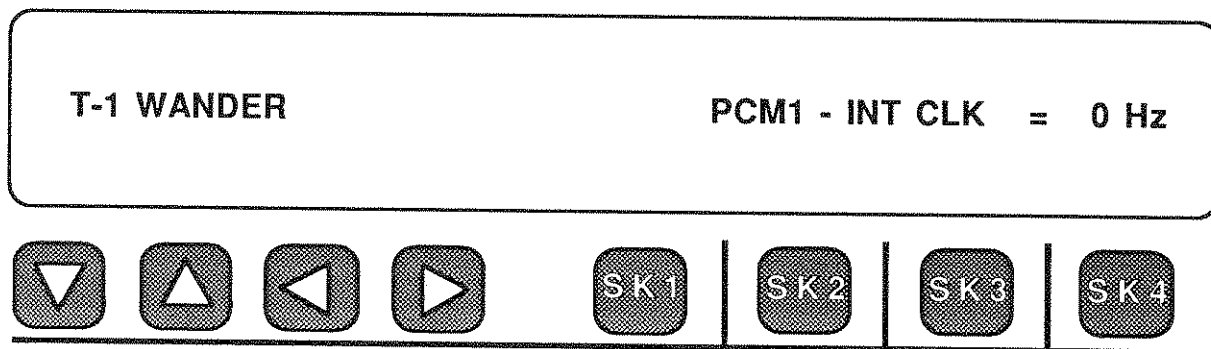

Do not expect PCM1 to agree with the 930A Internal Clock, unless the far-end is Loop Timed to the 930A. The actual value is not very significant. Large changes in the readings, however, indicate that the clock in your switch, or the clock in your 930A, is wandering and needs to be repaired.

5-43 HOW TO MEASURE FRAME AND BIT SLIPS, BPVs AND OTHER ERRORS WITH THE 930A (MENU OPTION 43)

Once you have selected the PCM Trunk Type and connected the 930A to the T-1 span, the 930A automatically monitors for, and counts, Frame Slips, Frame Errors, Bipolar Violations (BPV), Frame Losses and CRC Errors (CRC errors apply only to the ESF mode). You do not have to do anything to the 930A other than connect it to the span.

The 930A display will momentarily interrupt what it is showing you to flash the error messages on its screen if you are not in Menu 43. If you are in a dual direction mode such as MON-1&2 or D&I, it will also show you which direction the error came from.

To count errors, go to Menu Option 43: **ERROR COUNTERS**. To demonstrate the procedure, the MON-1&2 mode example will be used. The test connection diagram is shown below:

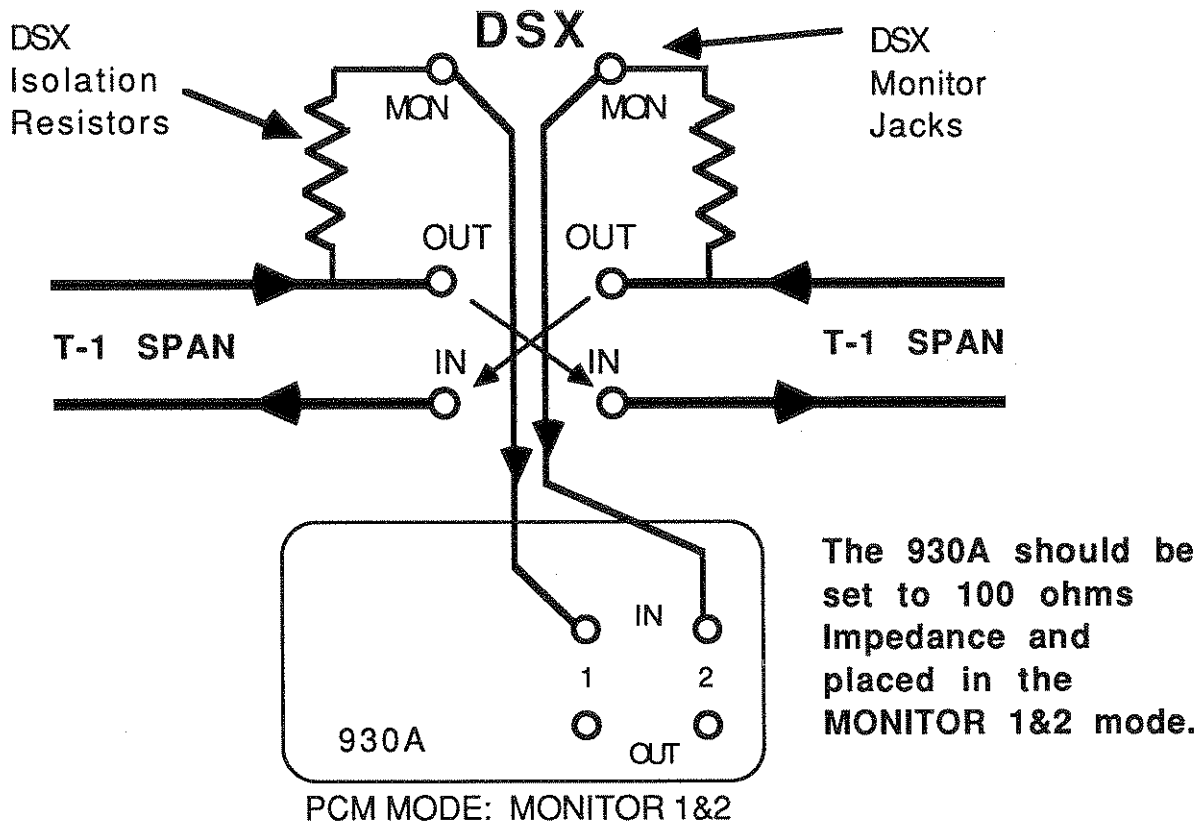

**TEST CORD CONNECTIONS FOR ERROR MONITORING
FIGURE 5-13**



When the 930A is in the **MON-1&2** mode, and connected to the DSX monitor jacks, errors will accumulate as they occur. You may be in the main PCM display, on any channel. **To view the errors**, do the following:

Press the OPTION MENU  Option Menu function key.

Use the UP/DOWN   arrow keys to get to Menu Option 43: ERROR COUNTERS.

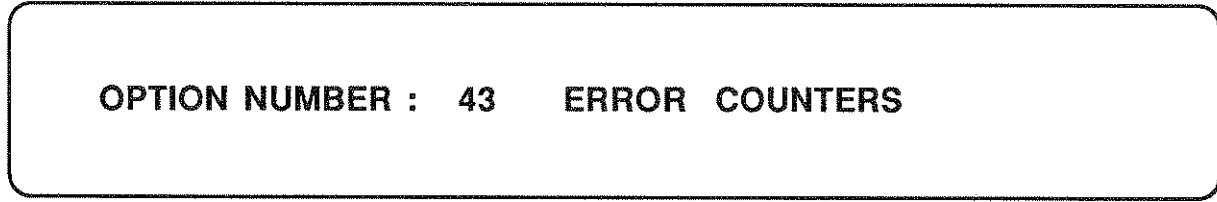

Press any softkey under the display and the current display of the error counts will be shown. For example, it might look like:

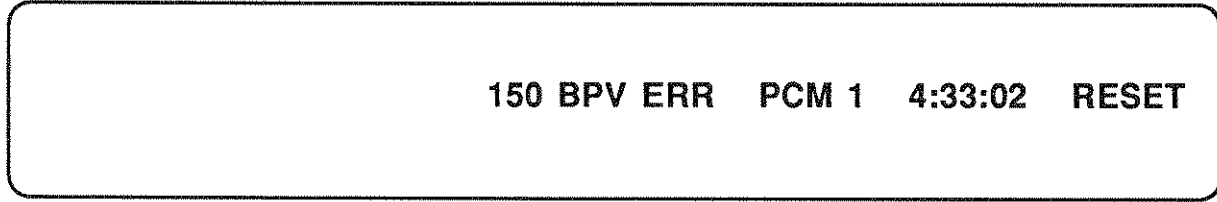

By pressing Softkey 1, or the **UP/DOWN** Arrow keys, you can page through the other counters to show you the Frame Losses, Frame Errors (or CRC Errors in ESF) and Frame Slips. Some example displays are:

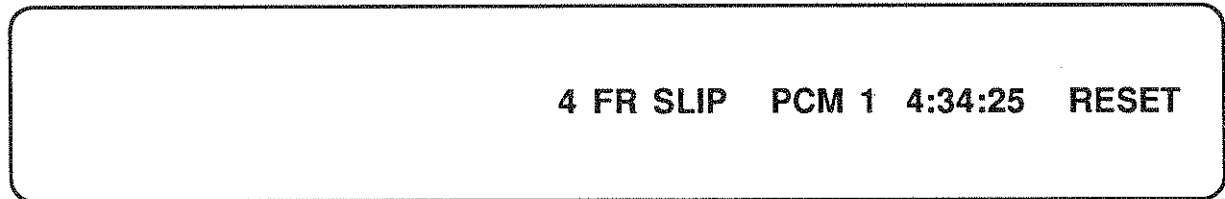
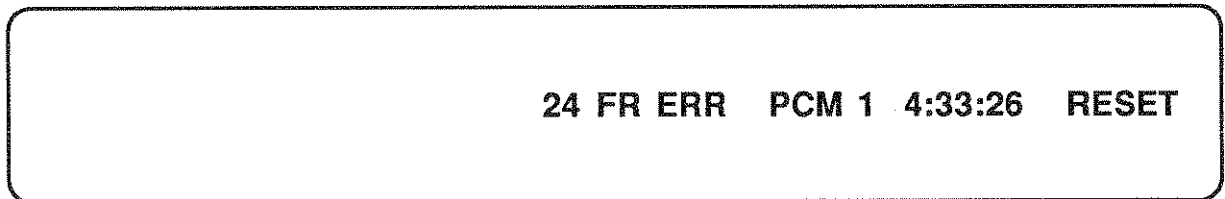

Since you are in the **MON-1&2** mode, you can easily check what is on side 2 by pressing Softkey 2 to toggle back and forth from side 1 to side 2. The 930A has independent counters on each side so you can see where the problems come from. This is like having two error counting test sets connected to the T-1 span. For this example, suppose you wanted to compare the Bipolar Violation counts on side 1 to those on side 2.

Let's say that side 1's counter is:

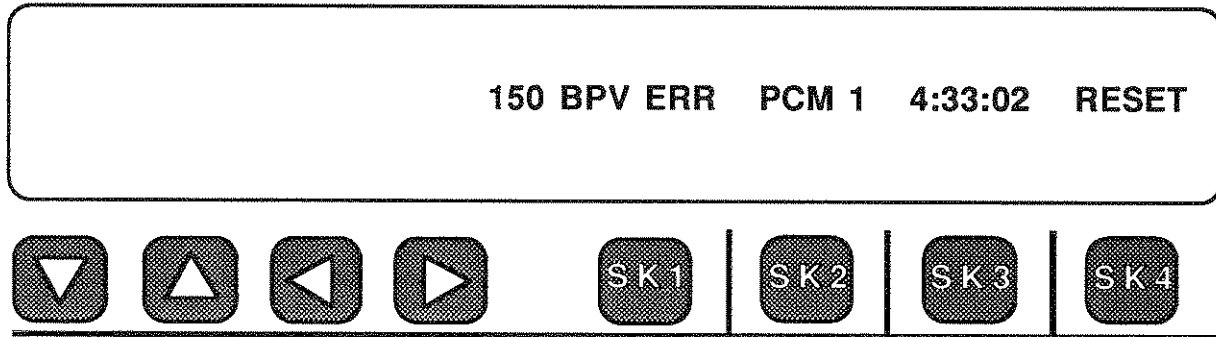

Now, press Softkey 2 and the display shows side 2 as:

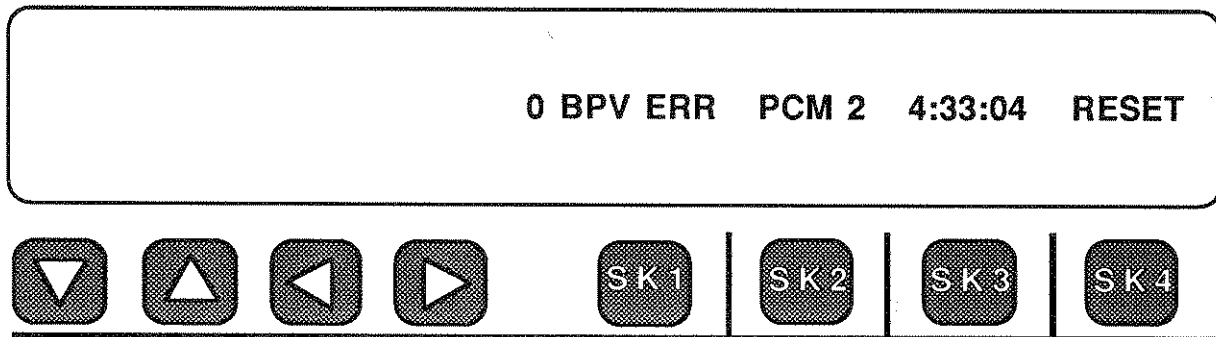

Note: Pressing the CLR or RESET key will clear all counters.

The parameters measured by the 930A in Menu Option 43 are: BPV Errors, BPV Rate, Frame Errors, Bit Slips, Frame Slips, Frame Losses, No PCM, Error Free Seconds, %EFS, Errored Seconds, %ES, Severely Errored Seconds, %SES, Failed Seconds, %Failed, Available Seconds, %Available, Unavailable Seconds and %Unavailable Seconds. All measurements are in accordance with CCITT G.821.

Note: Errors for ES and SES are based on Bipolar Violations and Frame, FPS, and CRC errors depending on the Frame type used.

5-44 T-1 ERROR HISTORY (MENU OPTION 44)

With Option 930A-08E or -09E, you also get Menu Option 44: **T-1 ERROR HISTORY**. This feature gives you up to 24 hours of history on the span under test. Error counts of Frame Slips, Bipolar Violations, Frame Errors, (CRC Errors on ESF), Frame Losses, Bit Slips (Wander), and Losses of PCM are recorded. Counts are displayed in 15 minute blocks for up to 24 hours at a time. If the 930A is connected to a printer (or a computer), the information is not limited to the last 24 hours.

As an example, suppose you have set up your 930A to monitor both directions of transmission, as shown below.

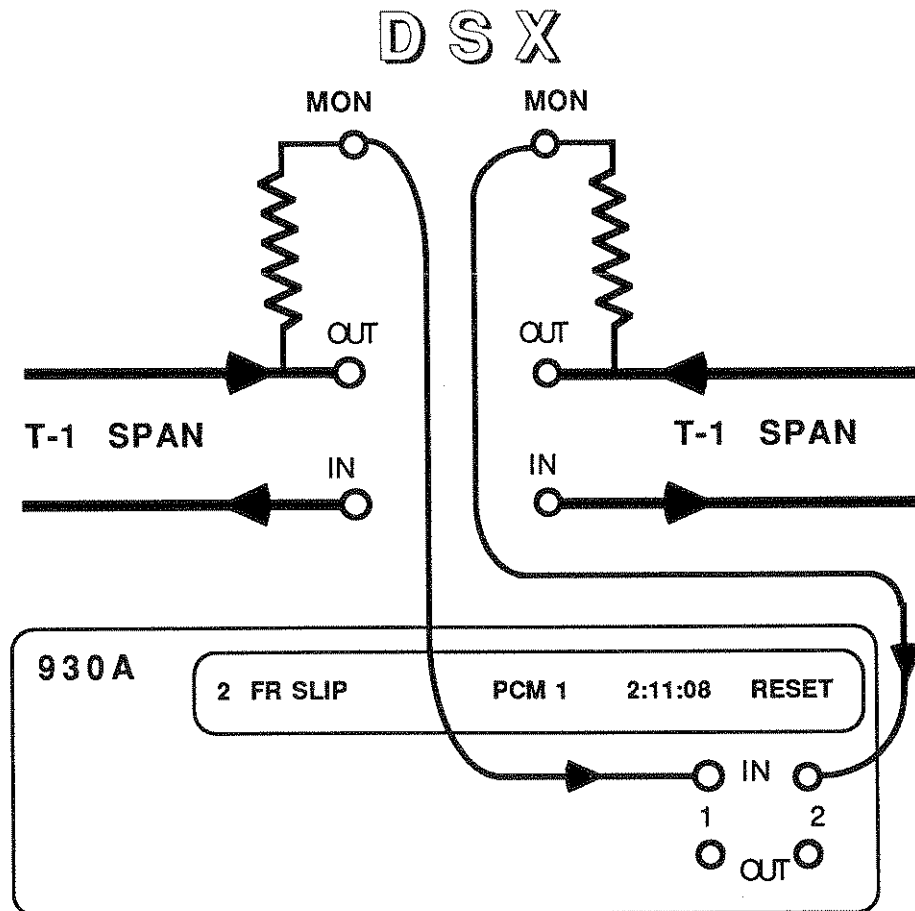

MONITORING IN BOTH DIRECTIONS
FIGURE 5-14

You go home, come back to work the next morning, and decide to see what went on overnight. Press the **OPTION MENU** function key and use the **UP/DOWN** arrow keys to get to Menu Option 44 or enter the number 44 on the keypad and press the **ENT** (Enter) key.

Once you are at Menu Option 44,

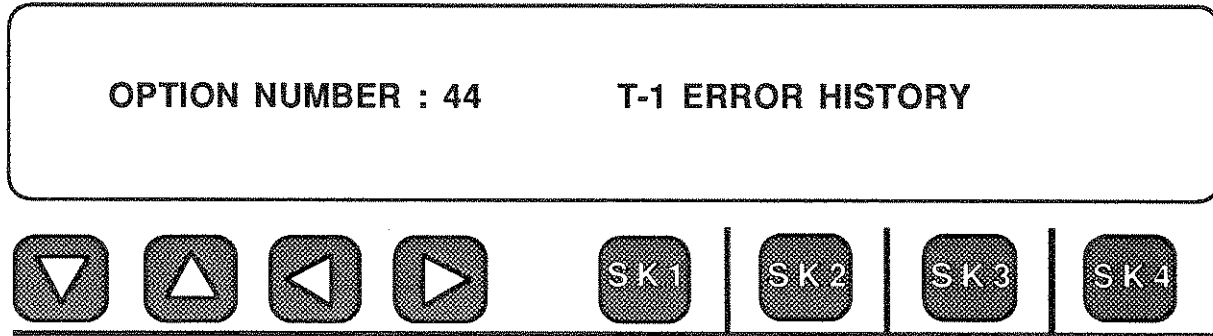

you enter it by pressing any of the softkeys under the display. The main display looks like:

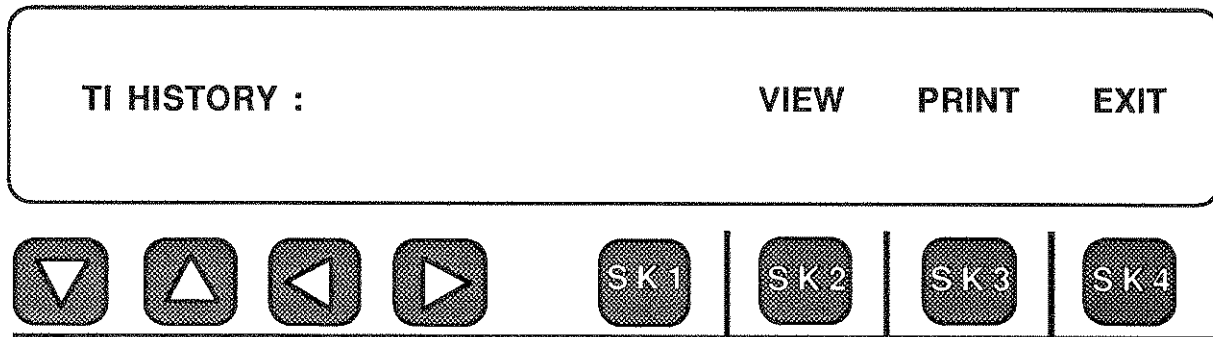

To review the errors which have occurred over the past 24 hours, just press Softkey 2 under **VIEW** and the history display will come up showing the latest block it is accumulating error data in. An example might look like:

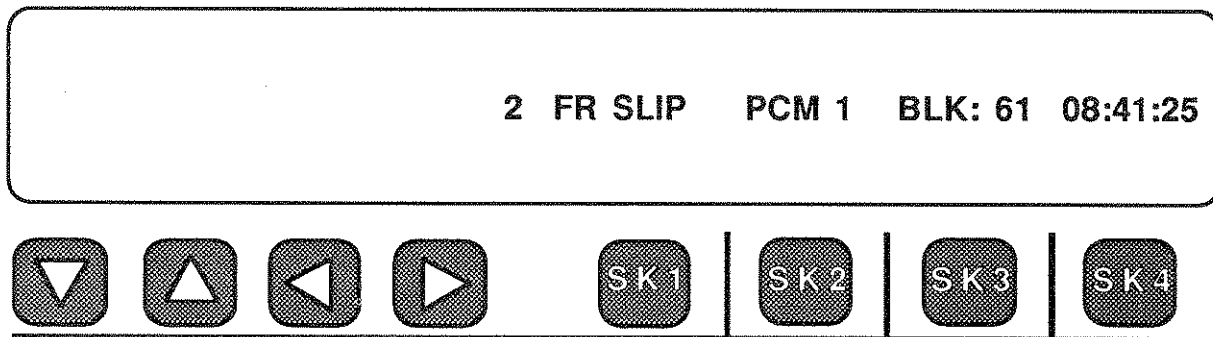

This is the sixty-first 15 minute block of time since the test began so this is roughly 15 hours later (the current time is 8:41:25 AM). To find out what has gone on over this time period, press Softkey 3 under **BLK: 61** and the 930A display will roll back to Block 1. For example purposes, the **BLK: 1** display is:

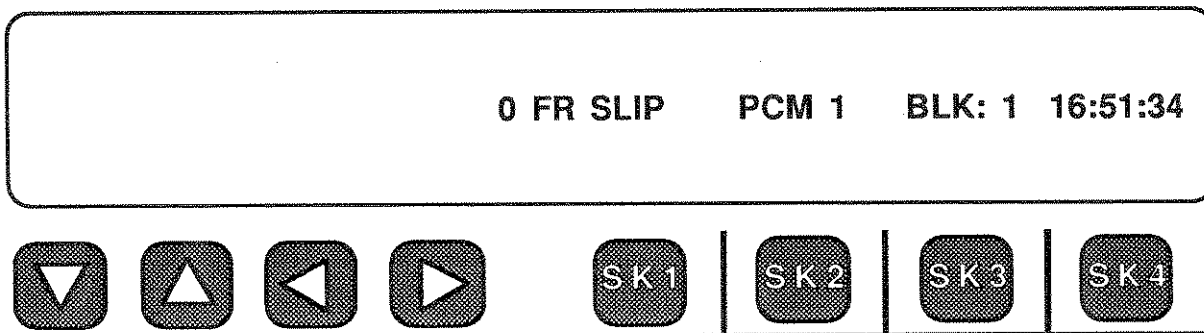

This indicates that the testing began at 4:51:34 PM. By pressing Softkey 1, you could scroll through the parameters. Similarly, by pressing Softkey 3 you could scroll through the blocks. This is useful because there may be a specific time period in which the errors occurred. There may be no errors in the other blocks. Of course, with up to 96 blocks this can be a bit tedious. You can spare yourself this dubious pleasure by connecting a printer or computer to the 930A (if you purchased option 930A-10C).

Since the 930A was monitoring both sides of the line in this example, you get the history of PCM 2 as well. To view this data, press Softkey 2 under **PCM 1** to toggle between sides. Suppose we were looking at BPVs on PCM 1:

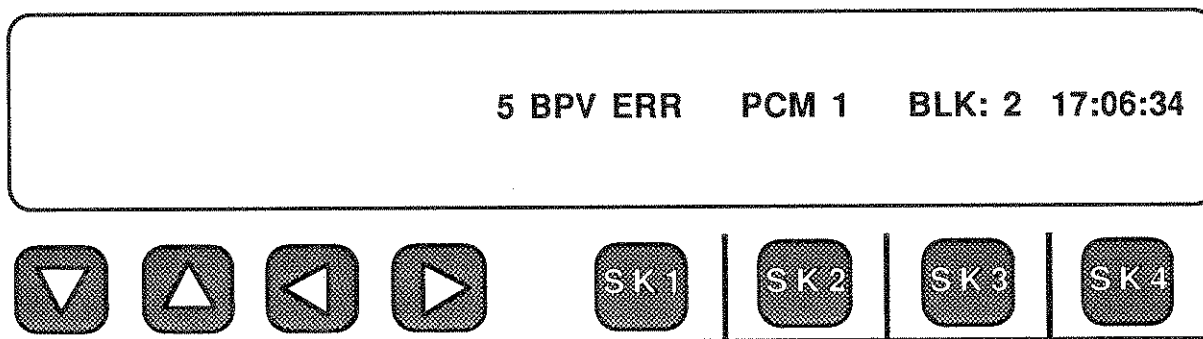

This shows 5 errors occurred during Block 2 coming into PCM 1 input. Pressing Softkey 2 will show us what came into PCM 2 in that same period. An example display is shown on the next page.

5-45 HOW TO INJECT A BPV OR FRAME ERROR (MENU OPTION 45)

There are times when you want to inject a Bipolar Violation or Frame Error (or CRC Error in Extended Superframe) toward the distant end, or on a loopback, to check integrity.

As part of Option 930A-08E or -09E, the 930A gives you the capability to inject a single BPV, Frame Error or CRC Error. This feature is only active when the 930A Trunk Type has been set to either the **TERMINATE** or **D&I** mode. Errors cannot be injected when the 930A is monitoring the T-1 facility.

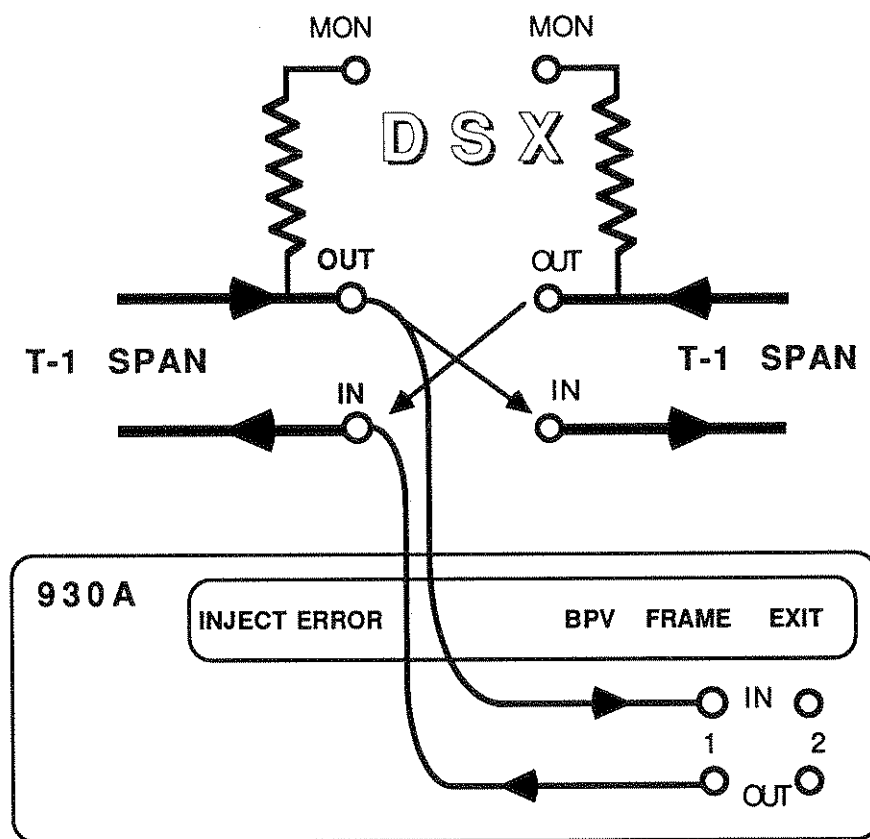

A typical connection of the 930A when operating in the **TERMINATE** mode (simulating a channel bank) is shown below.



INJECTING ERRORS WITH THE 930A
FIGURE 5-15

To access the **INJECT ERROR** feature, just follow the procedure outlined on the next page.

Press the OPTION MENU  Option Menu function key.

Use the UP/DOWN   arrow keys to get to **Menu Option 45: T-1 ERROR INJECT.**

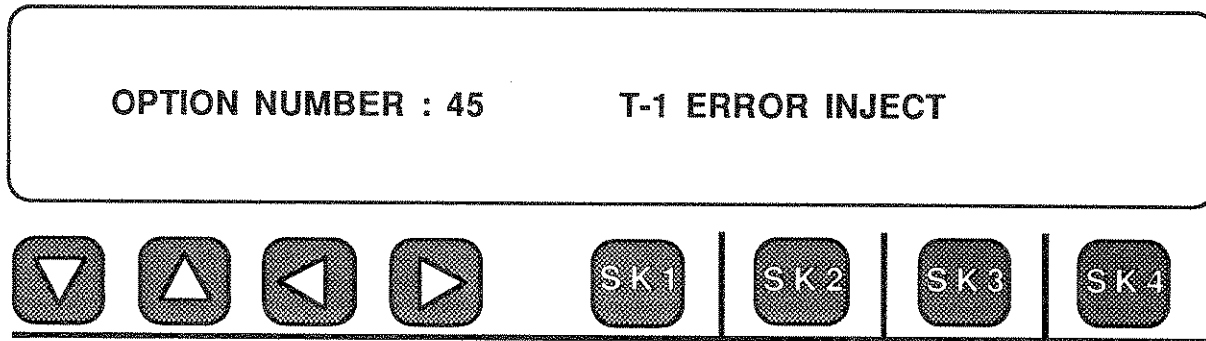

Press any of the softkeys under the display to enter the Menu Option and the display which appears will depend upon whether the 930A has been set for D4 Superframe or the new Extended Superframe (ESF) operation. The displays are shown below.

For D4 Superframe, the INJECT ERROR display appears as:

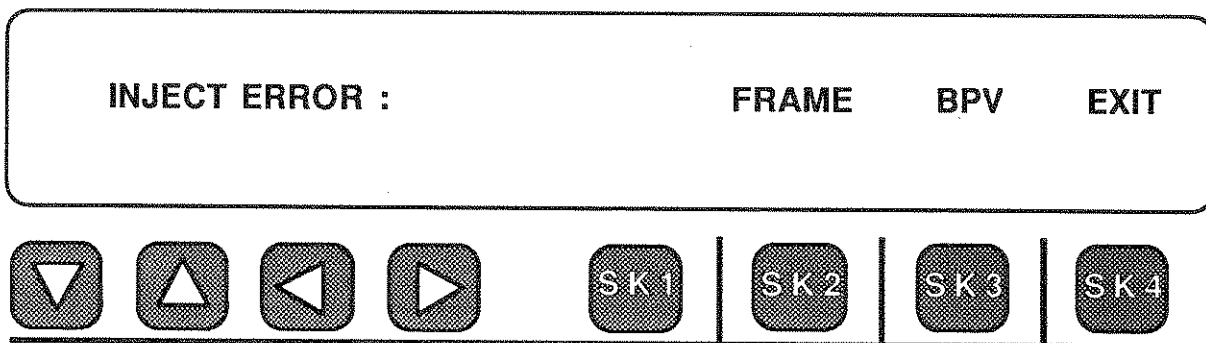

For Extended Superframe, the display appears as:

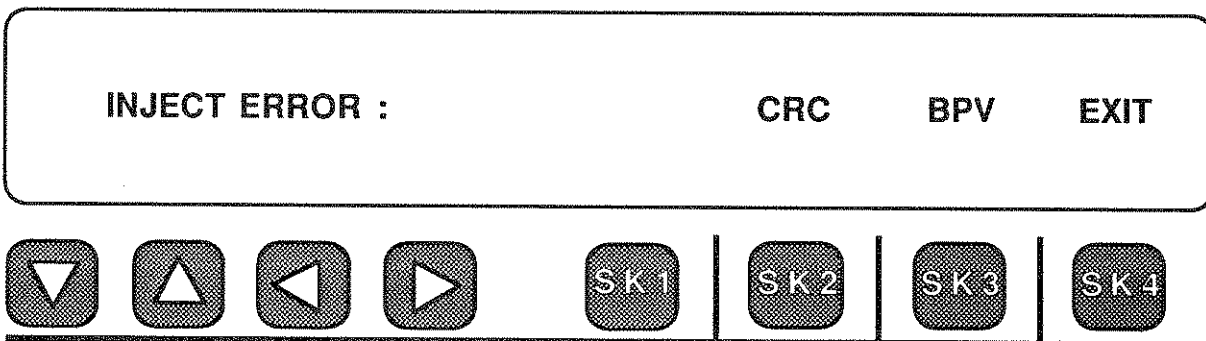

The operation is the same, except that CRC Errors are substituted for Frame Errors when the 930A is operating on an ESF span.

To inject an error, all you have to do is press the softkey directly beneath the type of error you want the 930A to send. For example, to send a Bipolar Violation (BPV) on the T-1 facility, press Softkey 3 under BPV.

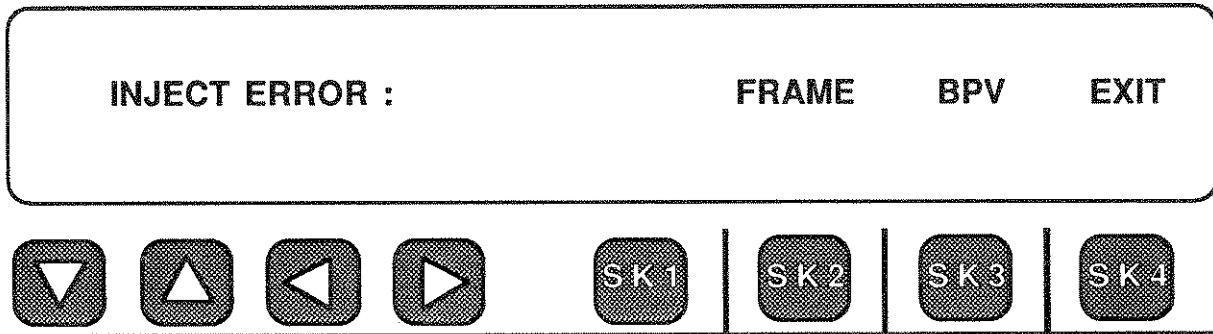

The display will momentarily flash a cursor over BPV,

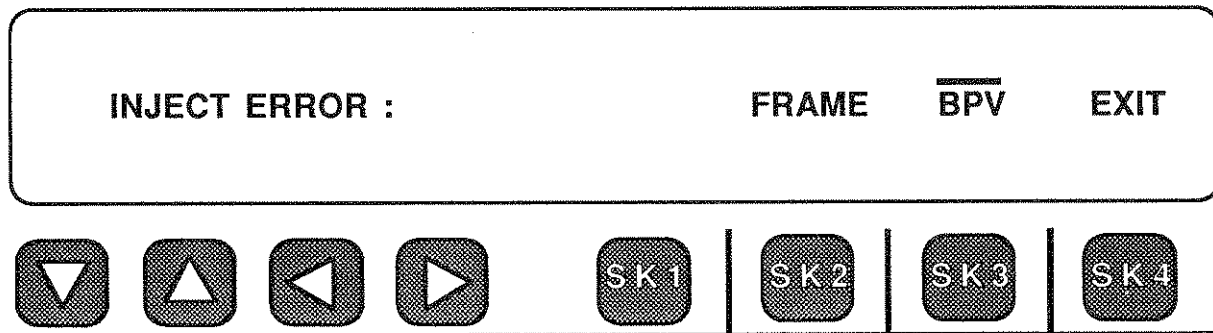

and the error will be sent. The procedure is exactly the same when you want to send a Frame Error or a CRC Error. If you are testing on a looped back facility, the 930A will record the error coming back. The display would flash "Bipolar Violation" and the BPV counter in Menu Option 43 would increment.

Note: Injecting a error in D&I will inject the error in only one direction, depending on the connection.

5-46 DS-1 BIT ERROR RATE TESTING WITH THE 930A (MENU OPTION 46)

If you have purchased Option 930A-22 for your 930A, you will find that Menu Option 46: **DS-1 BIT ERROR RATE (BER)** has been enabled. If you have Option 930A-08E then you have single direction BER testing capability. If you have Option 930A-09E then you have the equivalent of two BER test sets. Diagrams of test cord connections are provided in the following sections.

Every effort has been made to keep this feature simple and easy to use. For instance, **unlike other 930A functions, it is not necessary to set up the TRUNK TYPE to use Menu Option 46.** It does not matter what **TRUNK TYPE** the 930A was in previously. When you enter Menu Option 46 the 930A automatically sets itself to T-1 operation. The factory default parameter settings have been chosen to let you begin testing in most instances without changing any set-ups.

You will have to know how to connect test cords from the 930A to the T-1 under test (DSX or CSU jack access points). You will also have to know how to take the T-1 out of service prior to any testing. After that, there are few steps necessary to test the span using the 930A. The following sections outline test cord connections, BER testing in various situations, and how to change the test parameters if you have to.

5-46.1 BIT ERROR TESTING USING THE 930A

When you want to do a **BER** test using the 930A, just do the following:

Press the **OPTION MENU**  **Option Menu** function key.

Use the **UP/DOWN**   arrow keys to

get to **Menu Option 46: DS-1 BIT ERROR RATE.**

OPTION NUMBER : 46 DS-1 BIT ERROR RATE



Enter Menu Option 46 by pressing any of the softkeys under the display and the main selection menu will be displayed. You can also enter the number 46 from the keypad and then press the ENT (Enter) key. The 930A sets itself to T-1 automatically.

SELECT: SET-UP TEST HISTORY EXIT



Connecting the test cords from the 930A to the T-1 test access points is the next step. Figure 5-15 shows a typical connection for single direction testing at the DSX jackfield. At the far end the span can be looped back or another 930A (or any T-1 BER test set) may be sending back a test pattern.

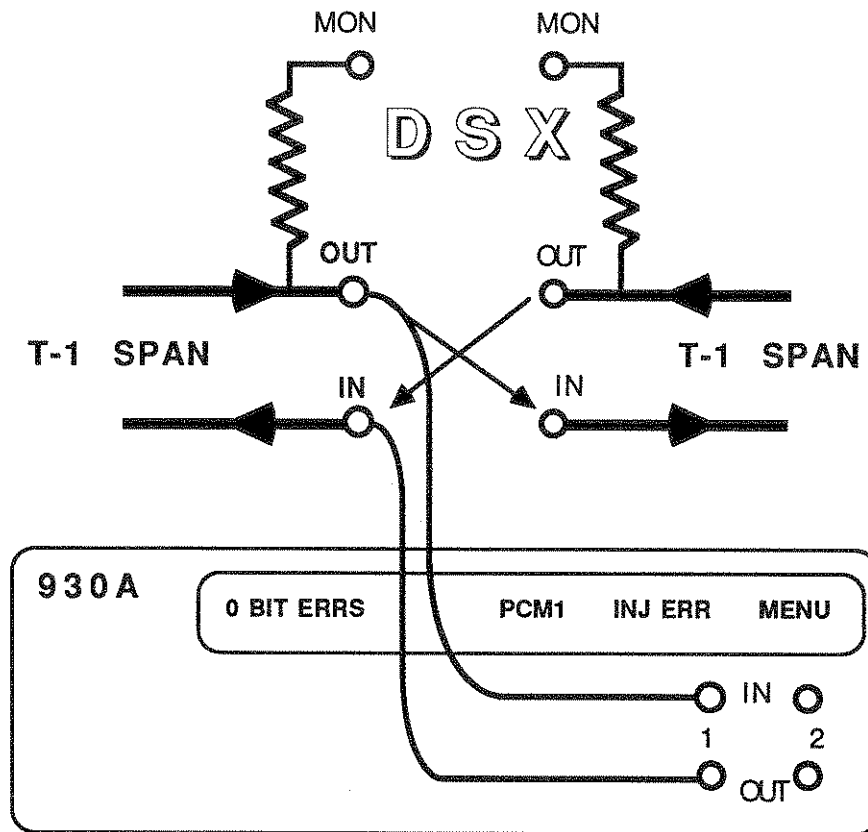

Test Cord Connections For Single Direction BERT
Figure 5-16

The 930A DEFAULTS are chosen such that you do not normally have to use the SET-UP menu to run a simple BERT test. For 90% of your testing all you need to do at this point is press Softkey 2 under TEST. The 930A will do the rest.

To begin testing at this point you press Softkey 2 under TEST. The factory default settings (located under SET-UP) are:

| | |
|---------------------|-------------------------------------|
| Pattern: | QRSS |
| Frame: | D4 Superframe |
| Clock: | Internal 1.544 Mbps ± 30 bps |
| Impedance: | 100 Ohms |
| Line Coding: | AMI |
| Test Length: | Continuous |

For most cases on a T-1 span, these defaults are what you need to perform a standard BER test.

If you have Option 930A-08E, then you have only the single direction BERT capability with Option 930A-22. If you have Option 930A-09E then you can do a single direction BERT, test BERT in both directions, or do a BERT on separate spans.

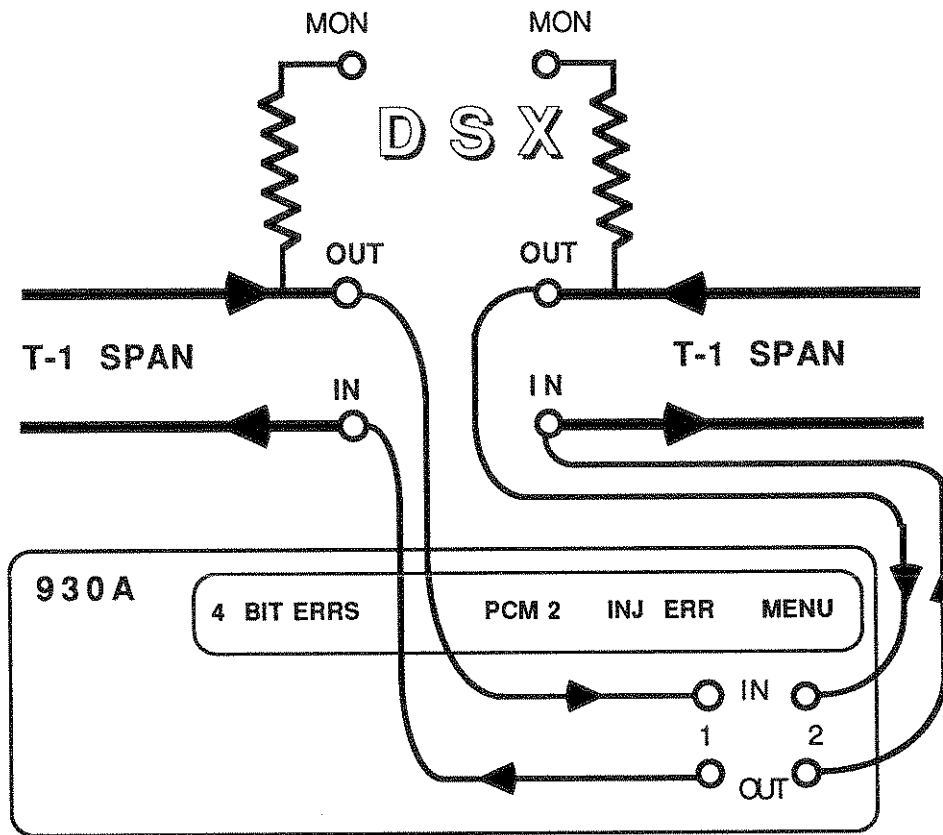

Test Cord Connections For Dual-Direction BERT
Figure 5-17

Both Side 1 and Side 2 of the 930A are always activated when you enter Menu Option 46 if you have Option 930A-09E. You can view either side during a test by pressing Softkey 2 under PCM1 to toggle between sides. If you do not connect anything to side 2 then all you will see if you toggle from PCM1 to PCM2 is a **NO SYNC** indication on side 2.

This makes the BERT feature very easy to use because it basically comes up running for most of your testing needs. All you have to do is hook up the test cords and select **TEST** from the BERT menu.

5-46.2 HOW TO CHANGE TEST PATTERNS, FRAMING AND OTHER PARAMETERS

This will go faster if we start at the beginning with the main **BERT** selection menu.

The moment you enter Menu Option 46, the 930A sets itself to the T-1 factory defaults or whatever you set in last. The previous Trunk Type setting does not matter. The 930A will flash a short message to inform you that it is setting itself to T-1.

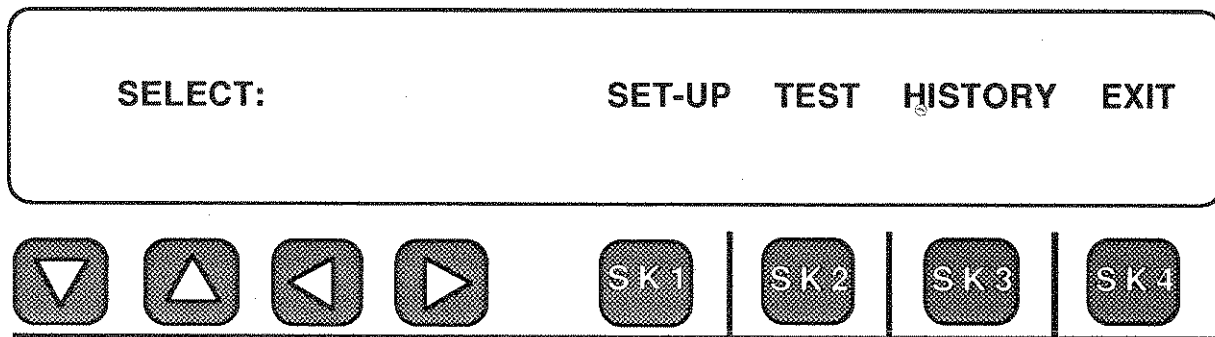

WARNING

Be sure the T-1 span you are connected to is out-of-service before you enter Menu 46.

To check or change the test parameters, press Softkey 1 under **SET-UP** in the main **SELECT** menu and the following display will appear.

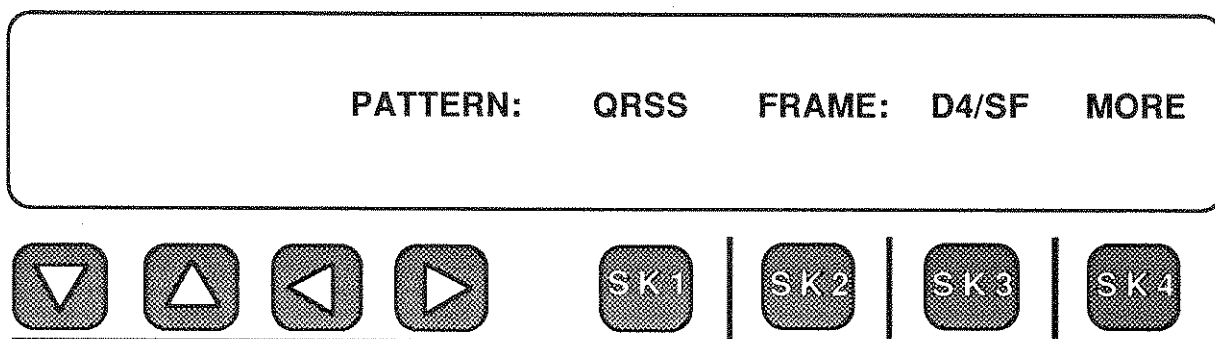

The most common things you want to change are the test pattern, framing and clock source so they are located right up front.

The default test pattern is **QRSS** and the default framing is **D4 Superframe** which is the most common format.

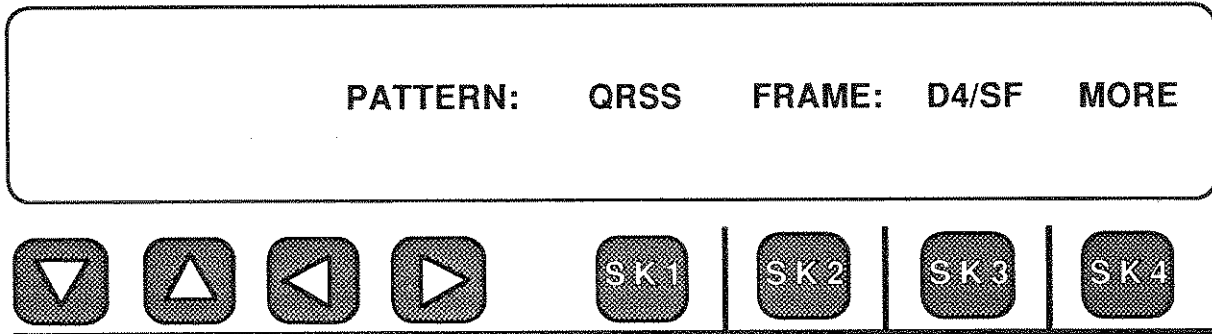

To change the test pattern, press Softkey 1 under **QRSS** and the other choices will appear. The order of appearance after **QRSS** is as follows:

| | |
|-------------------------|---|
| QRSS | Quasi-Random Word |
| USER | User definable pattern up to 24 bits long |
| 1:1 | Alternating 1 and 0 pattern |
| 1:7 | A 1 followed by seven 0's (also 1 in 8 pattern) |
| 3 in 24 | Three 1's in 24 bits (a stress pattern) |
| ALL 1's | All ones pattern (Blue Alarm) |
| 55 OCTET | A special 440 bit long stress pattern |
| 2²³-1 | A pseudo-random sequence 8 megabits long |
| 2²⁰-1 | A pseudo-random sequence 1 megabit long |
| 2¹⁵-1 | A pseudo-random sequence 32 kilobits long |
| 2¹¹-1 | A pseudo-random sequence 2047 bits long |
| 2⁹-1 | A pseudo-random sequence 511 bits long |

The only one of these patterns that requires any explanation is the **USER** pattern.

To access the **USER** pattern, press Softkey 1 under QRSS in the display above. The following display appears:

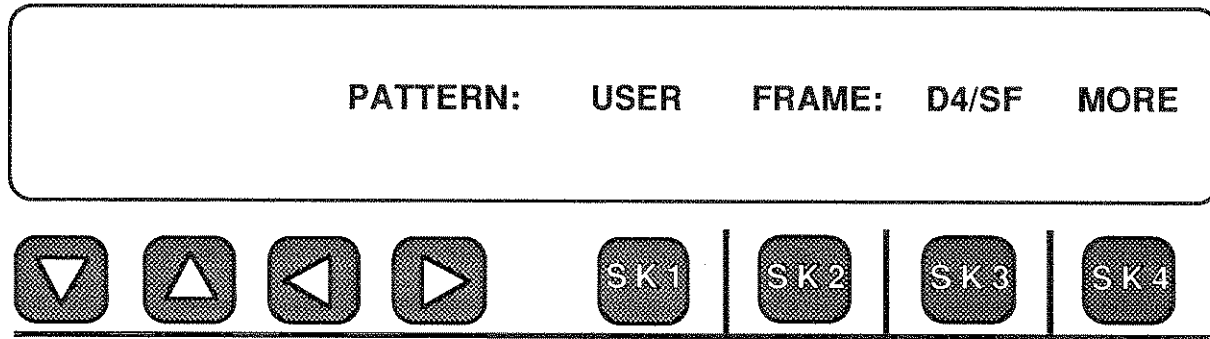

When this display appears, press Softkey 4 under **MORE** and the **USER** Pattern display will appear. As an example, a pattern is shown already entered.

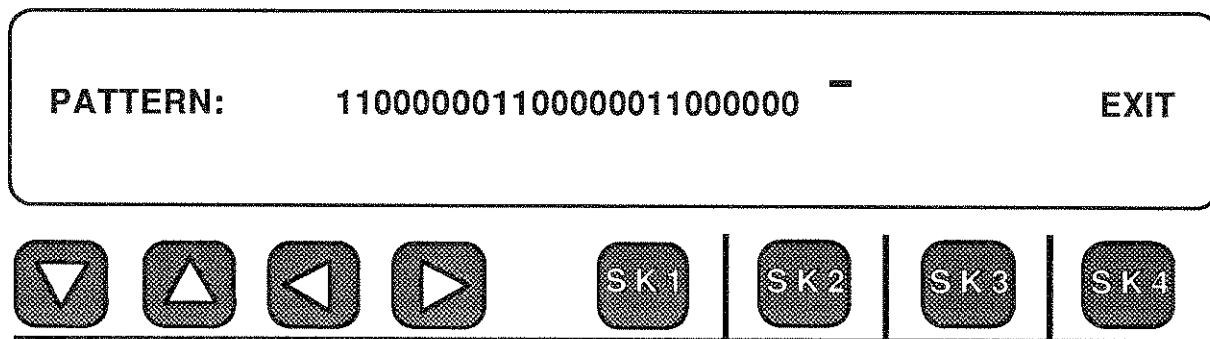

You can press the **CLR** (Clear) key to get rid of any existing pattern. Enter the pattern you want (up to 24 bits in length) using the **1** and **0** keys on the front panel. You can edit the pattern by using the **LEFT/RIGHT** arrow keys to position the cursor over the digit you want to change. Then enter a **1** or **0** from the keypad to overwrite the digit.

Once you have set the pattern up, just press Softkey 4 under **EXIT**. The pattern you input becomes the test pattern the 930A will use when you enter the **TEST** menu. By using the 930A's **STORE** and **RECALL** functions you can store up to 39 different **USER** patterns for future recall.

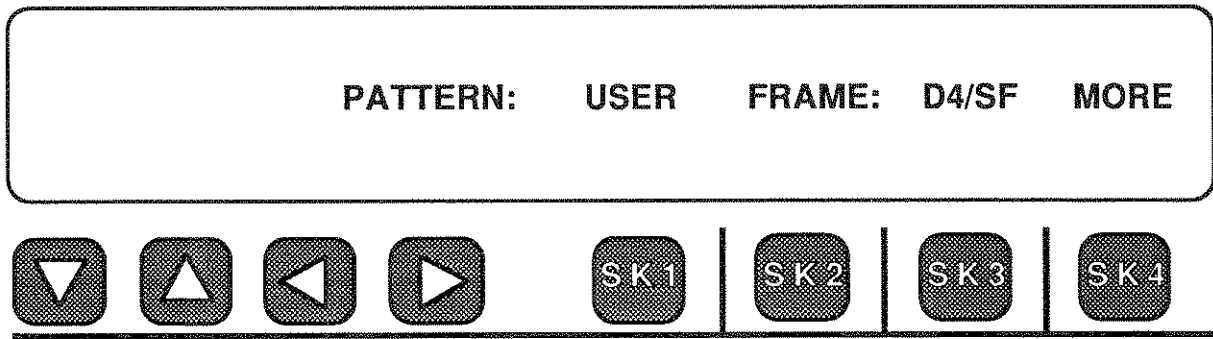

To change the Framing format, press Softkey 3 under **D4/SF** and the other choices will appear. In order of appearance after the default of **D4/SF** they are:

D4/SF
ESF
UNFRAMED

You choose which one you want by pressing Softkey 3 until your choice shows on the display. Press the **OPTION MENU** key to return to the main menu or press Softkey 4 under **MORE** to advance to the next parameter choice. The next most likely parameter to change is clock source and its display is:

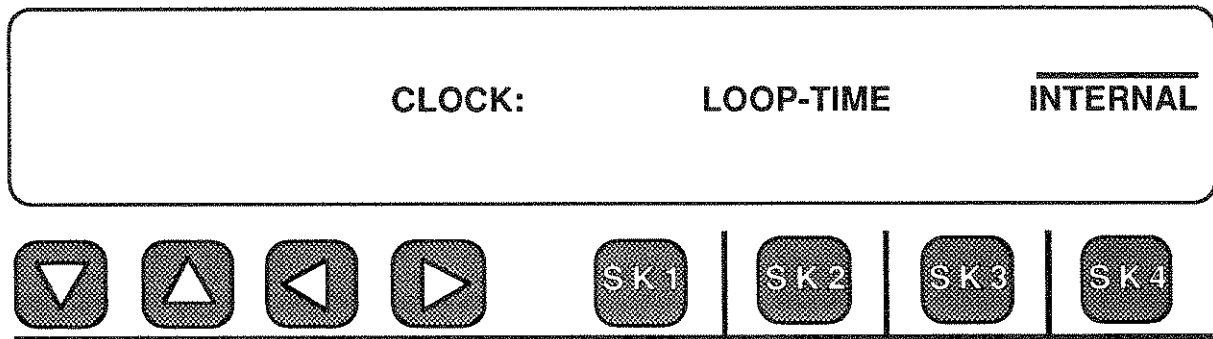

To change **CLOCK SOURCE**, you select either **LOOP-TIME** or **INTERNAL** clock as appropriate. The default is **INTERNAL** which means the 930A is supplying the 1.544 Mbps clock. The older BER test sets operated that way. If you are testing on a T-1 span the chances are good that you can derive clock from the span. In other words, you may want to be loop-timed. To select **LOOP-TIME**, press Softkey 2 under **LOOP-TIME** and the display will advance to the next choice. Pressing the **OPTION MENU** key will take you back to the main menu.

The next parameter choice is **IMPEDANCE**. The display is:

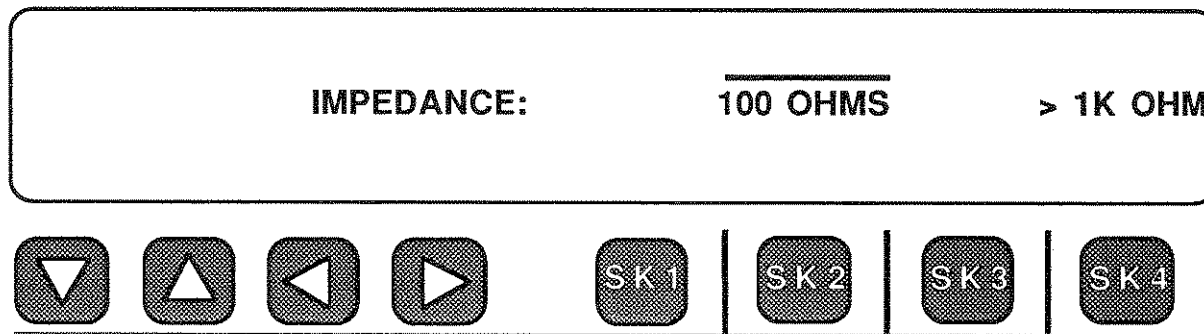

IT IS NOT GENERALLY NECESSARY TO CHANGE THE IMPEDANCE from its 100 OHM default. Since BER testing is done at the transmit and receive sides of the T-1, the 100 Ohm default should be used. BER testing is not a bridged measurement.

After you press Softkey 2 under 100 ohms (or Softkey 4) the 930A display will advance to the next choice.

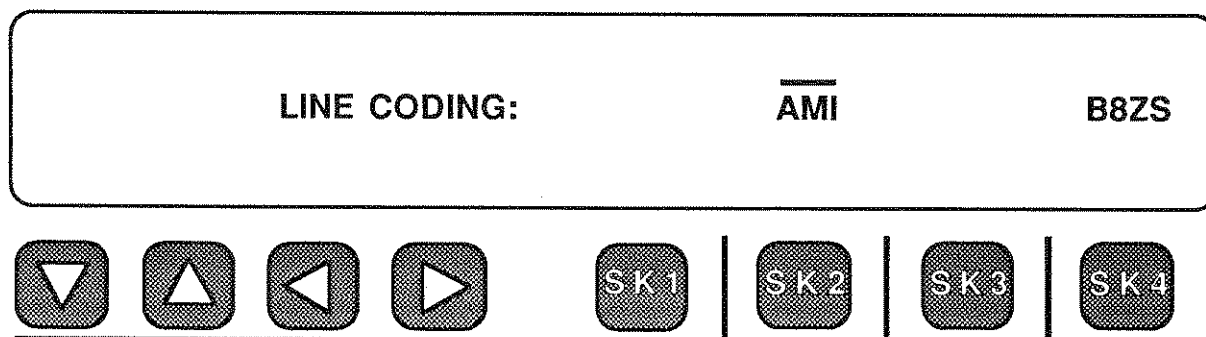

LINE CODING should definitely be left at the default setting. The default has been chosen to be Alternate Mark Inversion (**AMI**) because this is currently what most, if not all, T-1 carrier systems use. However, if you are using the 930A in a laboratory environment, or some other place where you may run across Bipolar 8 Zero Substitution (**B8ZS**) line coding, press Softkey 4 to change to **B8ZS**.

After selecting **AMI** or **B8ZS**, the display advances to the final choice which is **TEST LENGTH**.

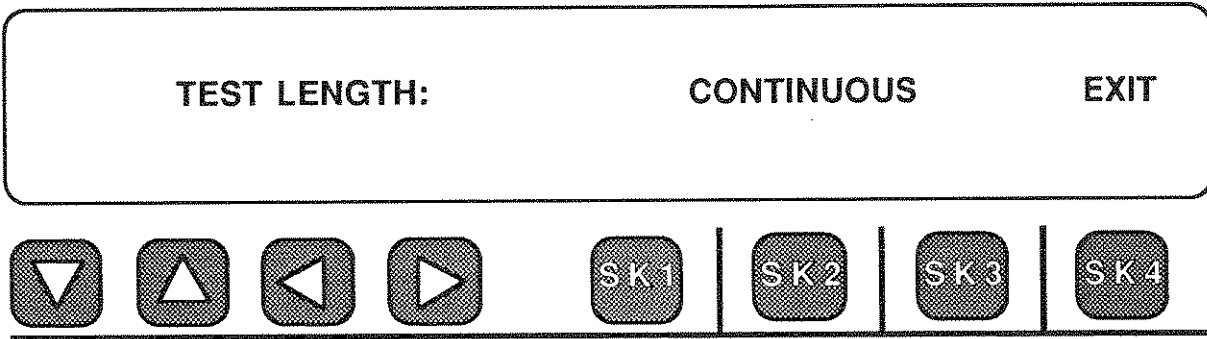

The default test length is **CONTINUOUS** which means the 930A will run the BERT test until you turn it off. But there are times when you may want to test a circuit for a specific time. The 930A allows you to choose test lengths of 15 minutes, 1 Hour, or 24 Hours duration in addition to running continuously. You can select one of these other choices by pressing Softkey 2 under **CONTINUOUS** until the time you want is displayed.

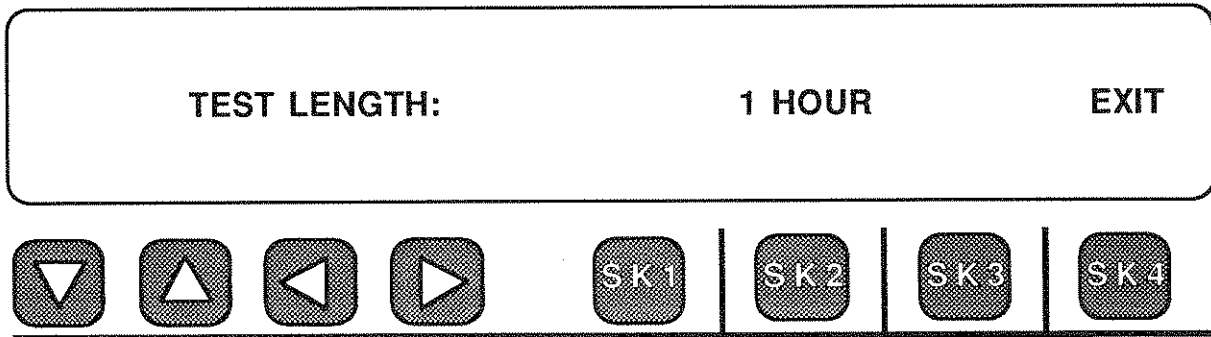

Once you have done this, press Softkey 4 under **EXIT** to return to the main select menu.

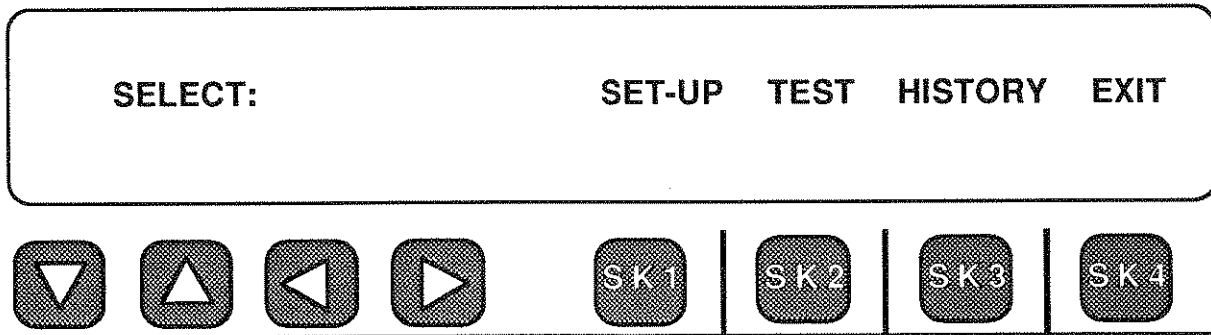

You do not have to run through all of the set-ups just to change one parameter. When you get to the one you want to change just change it and then press the OPTION MENU key to get outside again. Setup will also provide CSU configuration functions if Option (930A-44) is installed.

5-46.3 BER TESTING T-1 INTEROFFICE FACILITIES WITH THE 930A

Once you have set-up the 930A or decided to use the defaults, you are ready to connect the 930A to the T-1 facility you want to test.

Before you start to test, you must be sure that the T-1 has been removed from service. Bit Error Rate testing is only done on out-of-service facilities because you will be sending a pattern down the T-1. If anyone was talking on one of the channels at that time they would be knocked off the line.

You can make BER measurements end-to-end using a BERT set at each end, or you can have someone at the far end put up a patch to "Loop Back" the span. In any event, the principle is simple. The 930A sends out a known pattern (QRSS for example) and then it compares what it gets back bit for bit to see if there is a difference between what was sent and what was received.

TEST CONNECTION FOR BIT ERROR TESTING END-TO-END

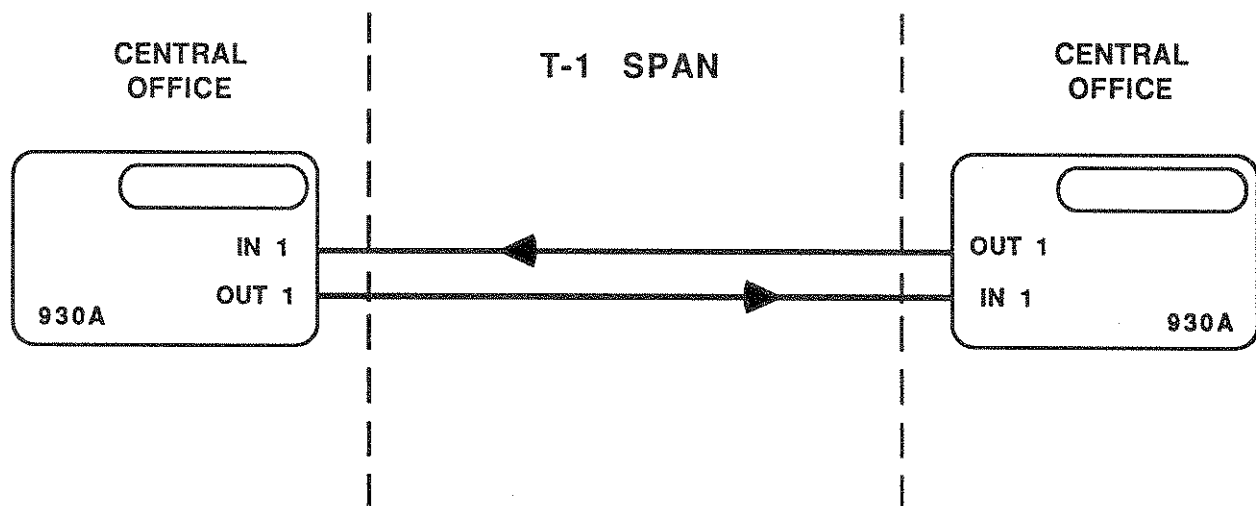

To do a BER test using the set-up above, all you have to do after you connect the test cords is go to Menu Option 46 on each unit, enter the Menu Option and press the softkey directly under the word **TEST**. This assumes that you are using the factory default settings in both units. If you see the words "**NO SYNC**" above Softkey 3 on the display, the chances are that the units are set to different patterns or some other parameters are different. A check of the **SET-UP** menu in each unit will reveal the differences. Both units must be set to the same patterns and parameters to achieve sync.

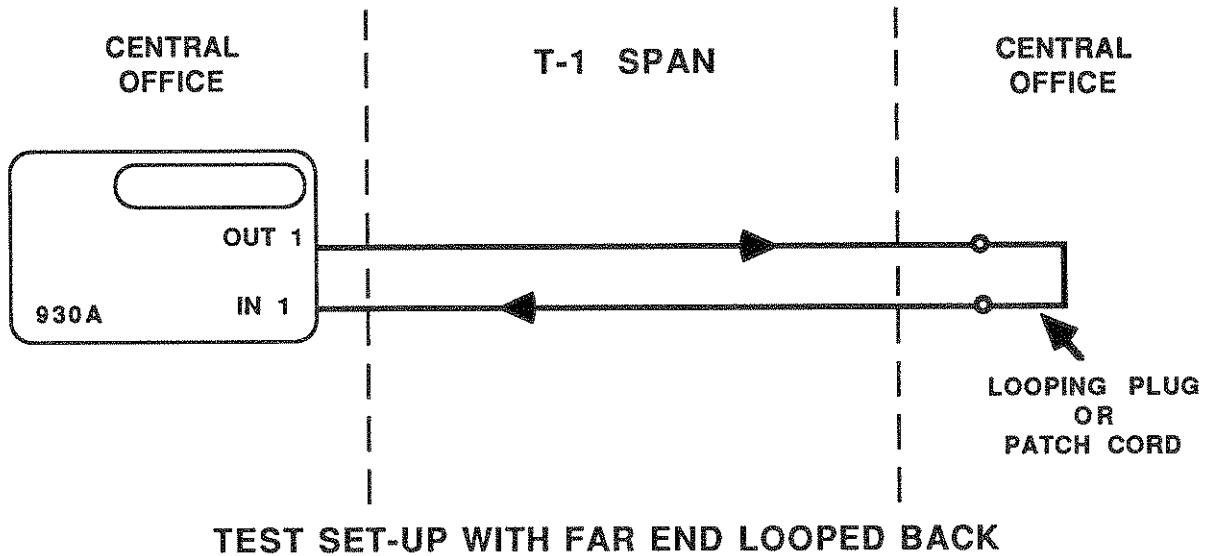

If the far end is looped back then all you have to do is use the factory defaults for testing.

In either case, after you press Softkey 2 under **TEST**, the 930A display should look like:

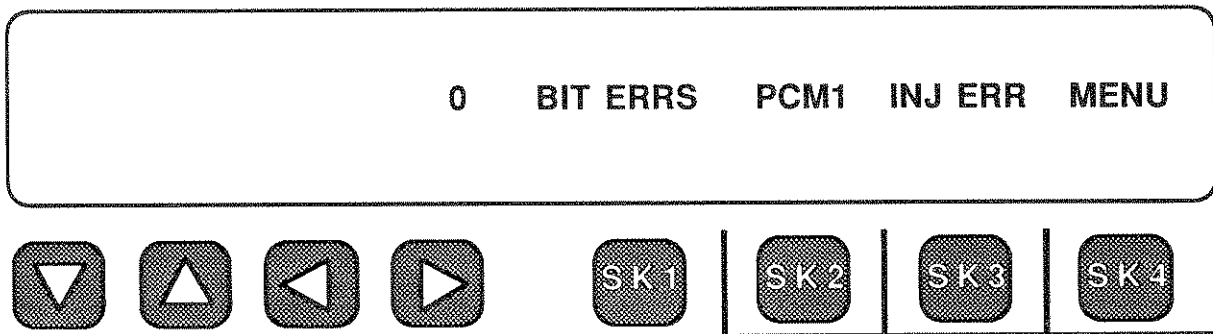

If you see **NO SYNC** instead of **BIT ERRS** then recheck the patterns, etc. and test cord connections. Have the far end check what they are sending or if they have looped back the right T-1 span.

When you have **SYNC**, press Softkey 3 under **INJ ERR** to see that the far end receives 1 error or that the 930A sees the error on a looped back span.

Press the **CLR** (Clear) key to reset the counters to zero before you begin testing.

5-46.4 TESTING TOWARD A T-1 CSU WITH THE 930A

When testing on a T-1 facility that terminates into a T-1 Channel Service Unit (CSU) on a customer's premises, you can have the 930A send the **LOOP-UP** code toward the CSU. This causes the CSU to loop the T-1 back toward you. You do not need someone at the far end. The test cord connection is shown below:

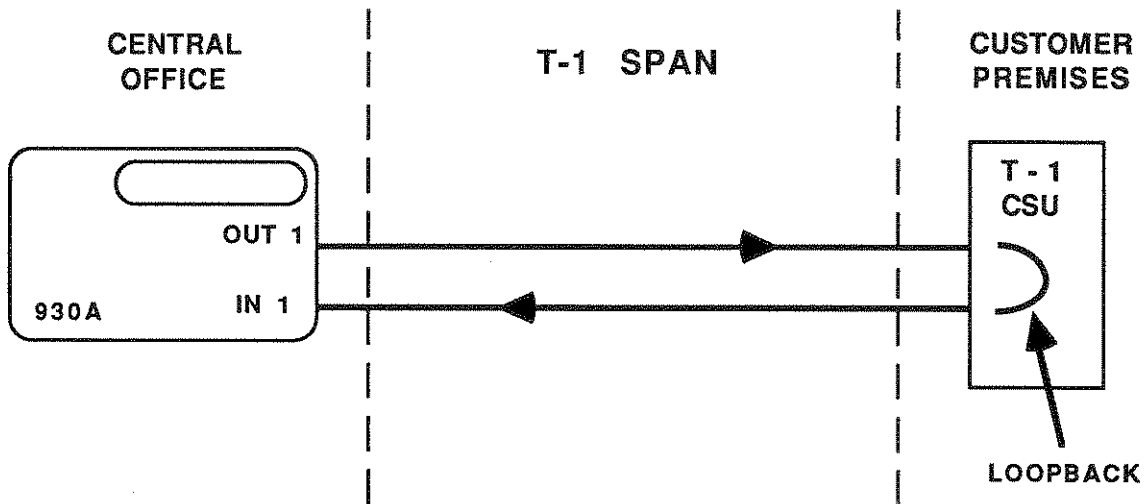

After you have connected the test cords to the 930A, entered Option Menu 46 and pressed Softkey 2 under **TEST**, you will see the following display:

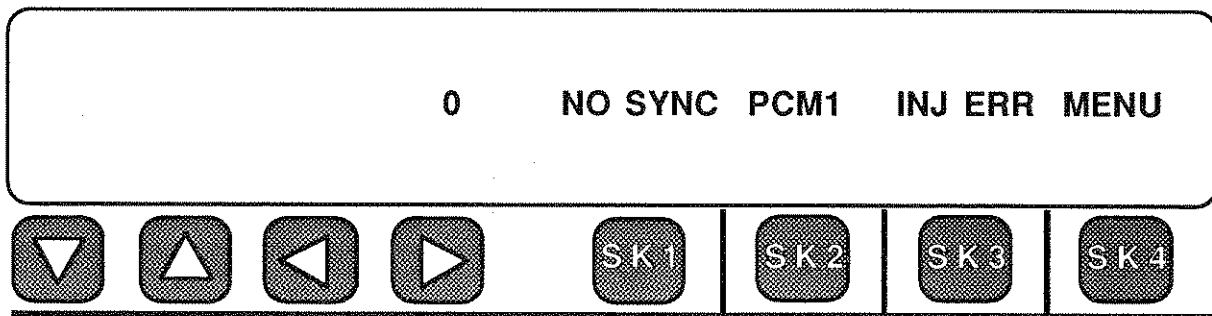

Note that there is a **NO SYNC** indication on the 930A display, because no pattern is coming back from the far end. You must **loop back the CSU** by sending it the **LOOP-UP** code for approximately 5 seconds. To do this with the 930A, press Softkey 4 under **MENU** and the **SELECT** display will appear.

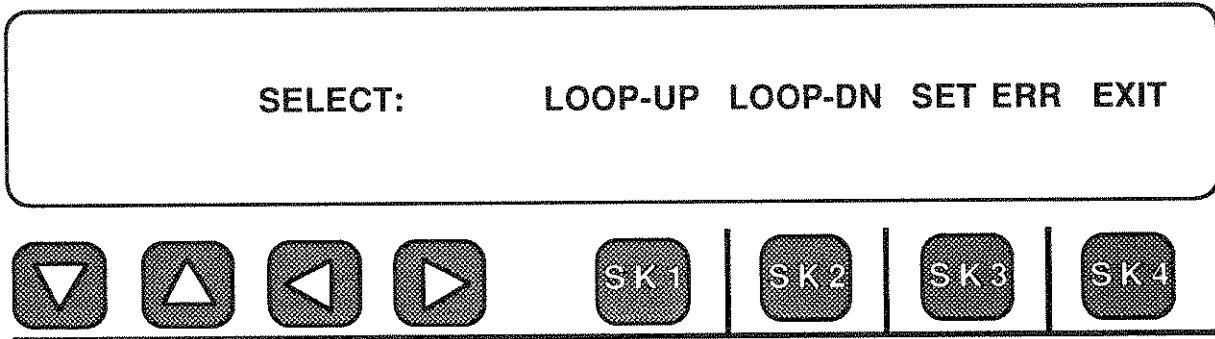

To Loop the CSU you start by pressing Softkey 1 under LOOP-UP and the display will change to:

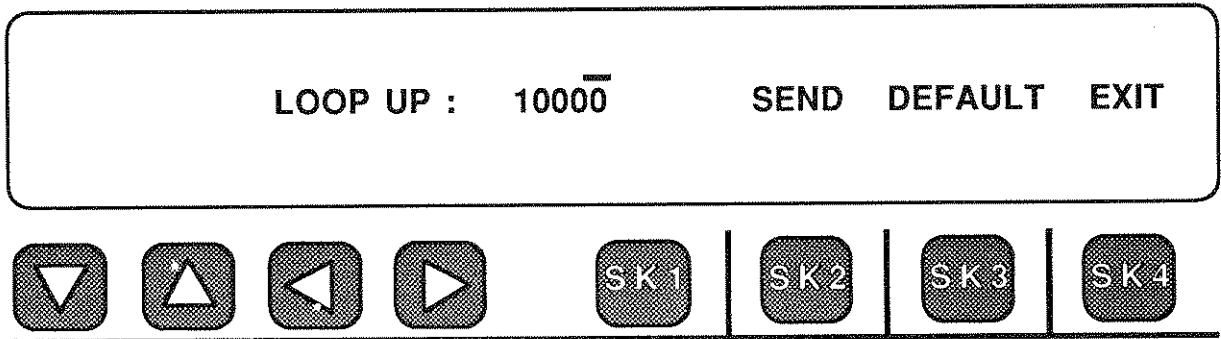

The default Loop-Up code shown above is the most common code and is sometimes referred to as the Verilink code. Loop-Up is purposely a 2-stage process so that you cannot accidentally send out the code. It also gives you a chance to edit the pattern at this point. You may want to enter a Loop-Up code for a Network Interface (a different device and code than a CSU). The CLR (Clear) key will clear the displayed pattern. Edit the pattern by moving the cursor over a digit and changing it to a 1 or a 0.

To send the Loop-Up code, press Softkey 2 under SEND. The 930A display will show:

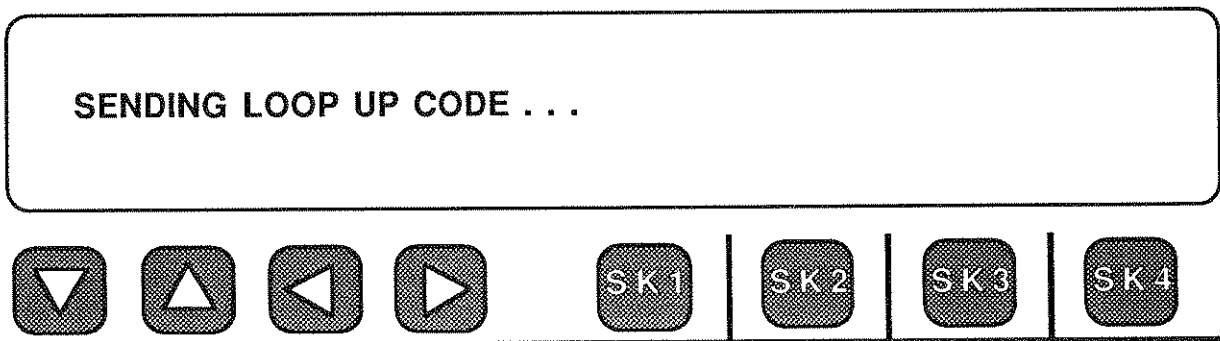

When the Loop-Up has been achieved the 930A will display the words "REMOTE LOOP UP SUCCESSFUL". If Loop-Up is not successful the 930A will announce "REMOTE LOOP UP UN-SUCCESSFUL".

After achieving Loop-Up the 930A display will change immediately to the main BERT menu.

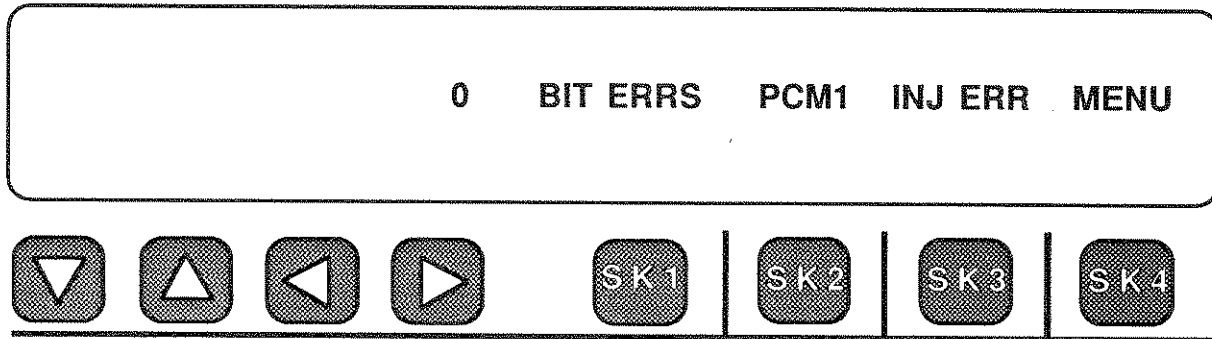

Note that now the 930A has achieved SYNC. The NO SYNC message has been replaced by the INJ ERR function. To test the integrity of the Loop you can inject a single error to see if the 930A counts it coming back. Press Softkey 3 under INJ ERR once and the 930A display should change to:

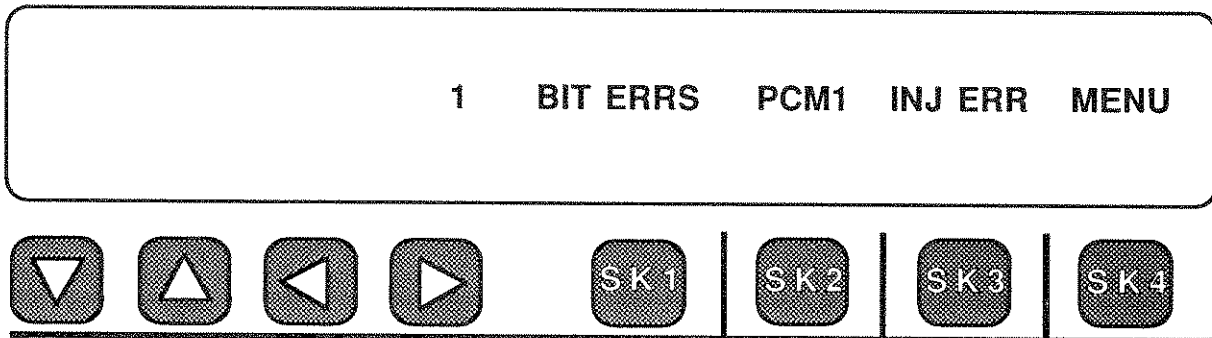

If you see the error coming back you know you have a good loop. Press the CLR (Clear) key to zero the counters and let the 930A run. If you do not see any errors (scroll through all the counters using Softkey 1 or the UP/DOWN arrow keys) in 15 minutes the span is probably working. If the problem is intermittent then you should run the test for at least 24 hours.

After your testing is complete, press Softkey 4 under **MENU** to get back to the **SELECT** menu.

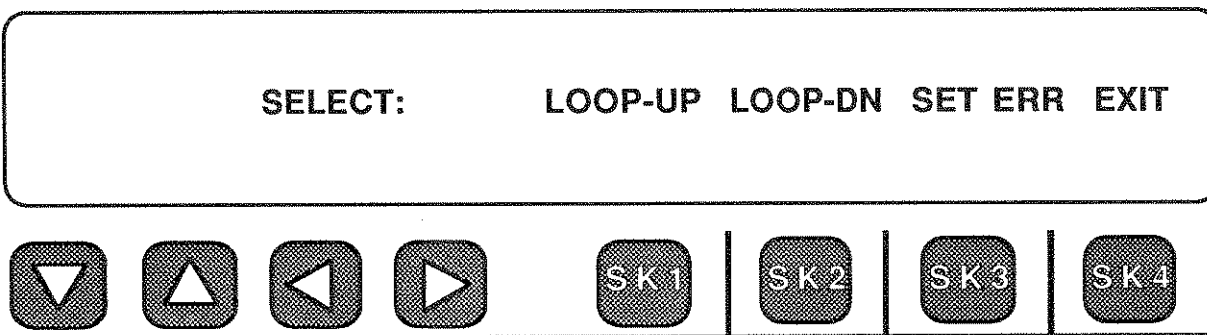

Then press Softkey 2 under **LOOP-DN** and the display will change to:

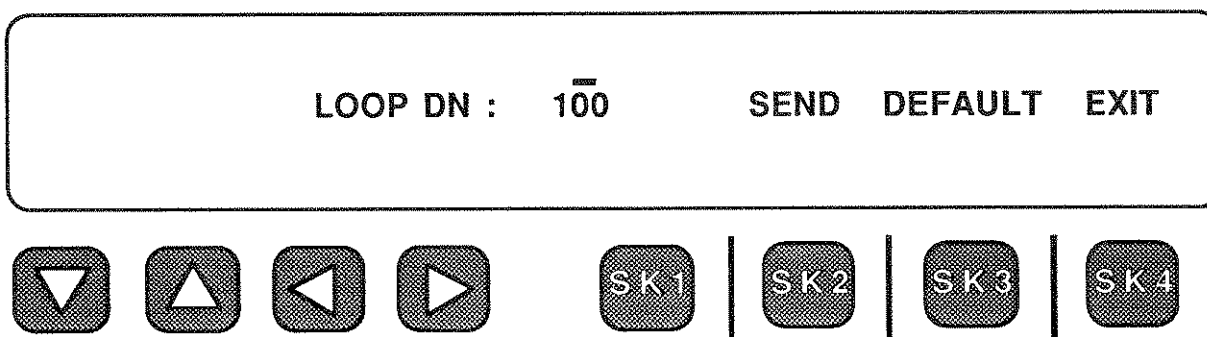

Finally, press Softkey 2 under **SEND** to restore the CSU to normal operation. If you are connected to a standard CSU then the default Loop-Down code (shown above as 100) is what you want to send. If you need to send another code then edit the pattern first before you press **SEND**.

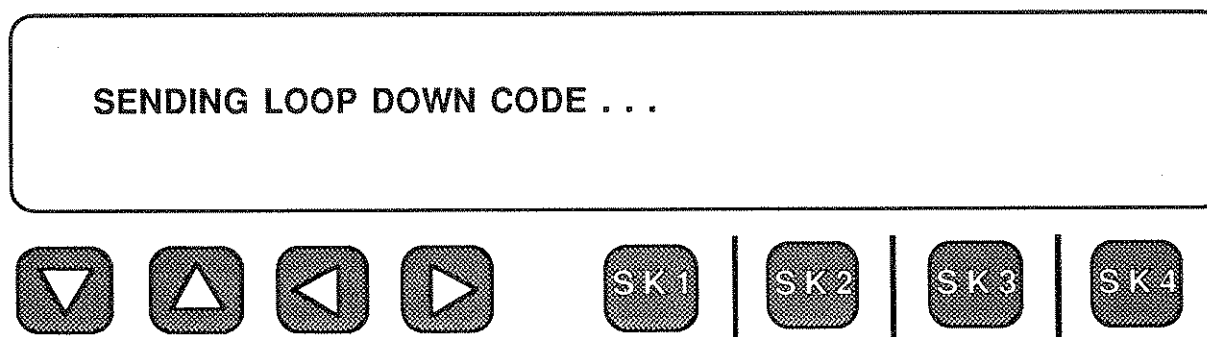

When the Loop has been taken down, the 930A will announce "**REMOTE LOOP DOWN SUCCESSFUL**". It will then revert to the main BERT display but should now indicate "**NO SYNC**" since there will be no returned pattern.

5-46.5 BER TESTING TWO T-1 SPANS SIMULTANEOUSLY

When the 930A is equipped with purchased Option 930A-09E and 930A-22 it gives you the equivalent of two BERT sets. Because the two PCM interface boards which make up Option 930A-09E are identical, both are enabled when you enter Menu Option 46. This means that you can connect the jacks labeled PCM 1 IN/OUT and test one span while you connect PCM 2 IN/OUT to another span. All you have to do after you are connected is to press the softkey under TEST. After that you press Softkey 2 under PCM1 to toggle between looking at the errors on Side 1 and those on Side 2. The test connection is shown below.

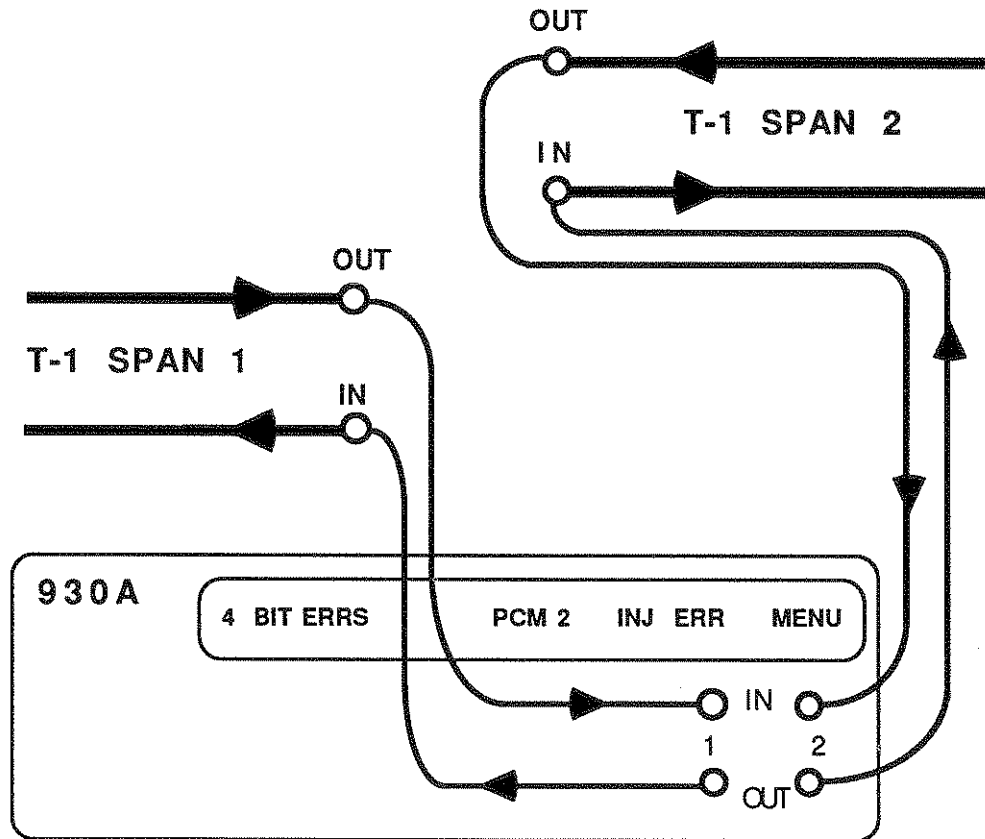

**TWO T-1 SPANS BEING BER TESTED SIMULTANEOUSLY
FIGURE 5-18**

This connection would be used to test two separate T-1 spans. But there may be times when you are in the middle between two other offices and you might want to do a BER test toward each office simultaneously. The diagram on the following page shows this connection.

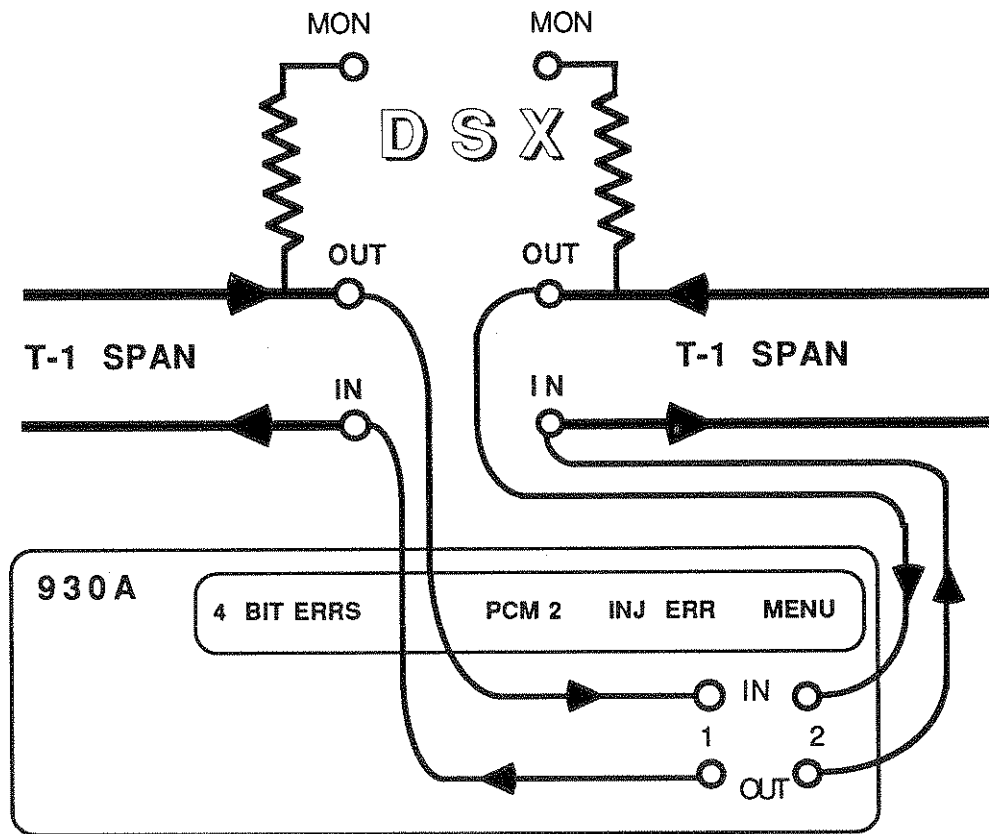

SIMULTANEOUS BER TOWARD TWO OFFICES
FIGURE 5-19

In this case, the T-1 span is broken at the intermediate office and the 930A is doing a **BER** test toward the two end offices. This can save you a lot of time especially if you have to do a 24 hour test in each direction. This feature lets you test both directions at the same time so you save 24 hours.

Again, the **HISTORY** for both sides is accumulated and all you have to do to check on the test is to press Softkey 2 to toggle between Side 1 and Side 2 results.

5-46.6 HOW TO SEND ERRORS AND SELECT OTHER TYPES

The factory default injects single bit (or logic) errors when the softkey under **INJ ERR** on the main BERT display is pressed.

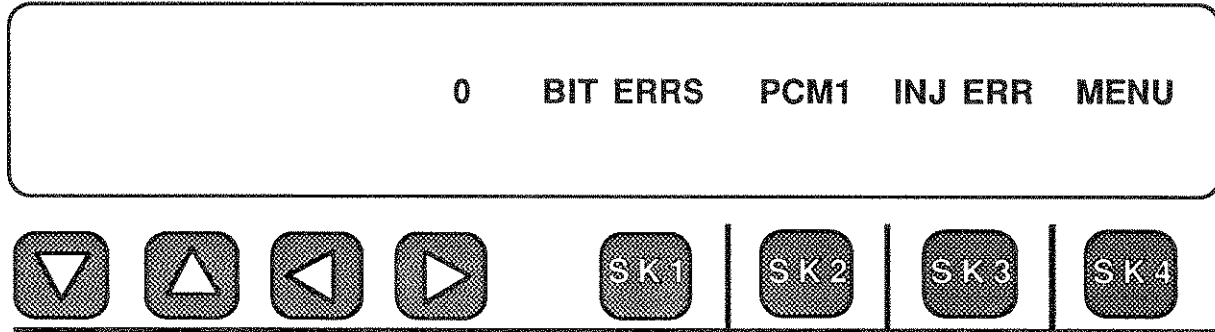

To change the type of errors being injected, press Softkey 4 under **MENU** to bring up the main **SELECT** display.

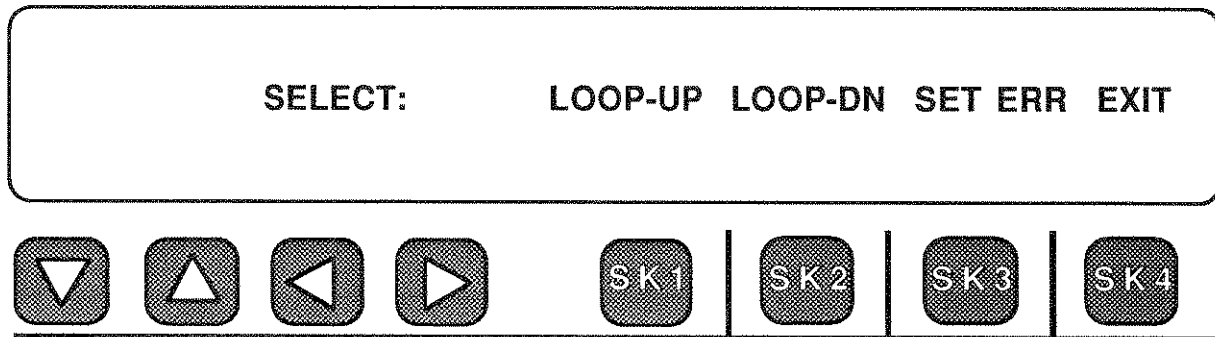

Press Softkey 3 under **SET ERR** to bring up the **ERROR TYPE** display. There are three possible displays depending upon whether you have chosen D4/Superframe, ESF or Unframed operation.

D4/SUPERFRAME

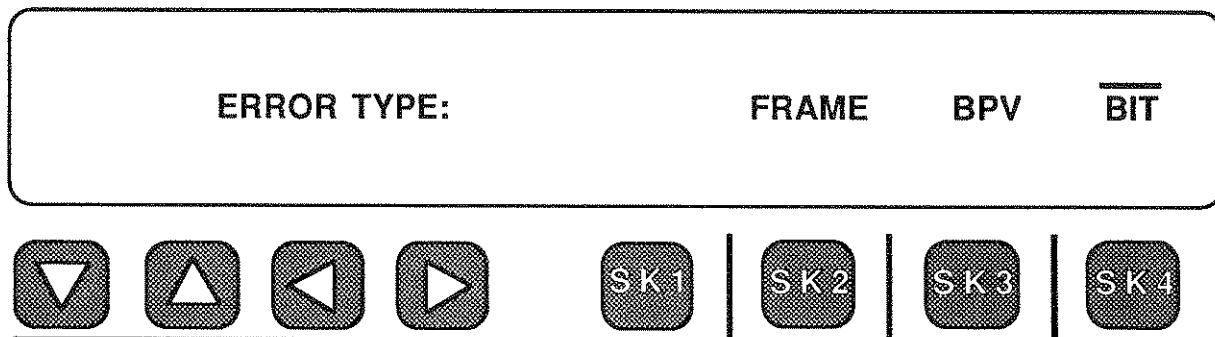

ESF

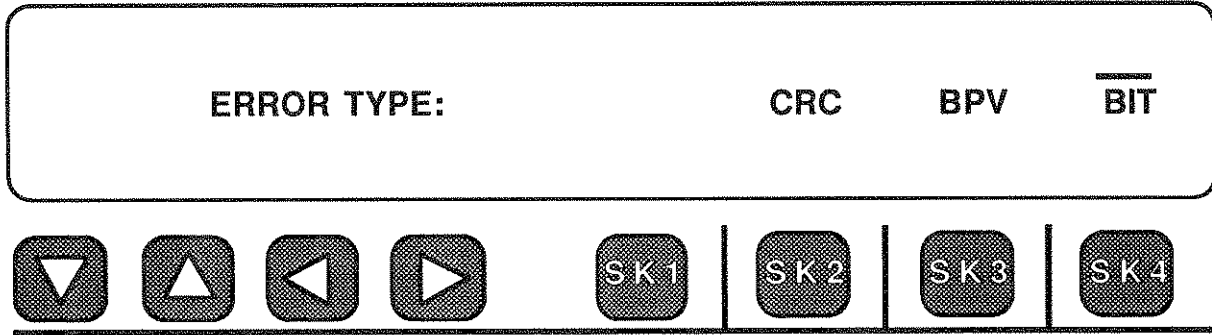

UNFRAMED

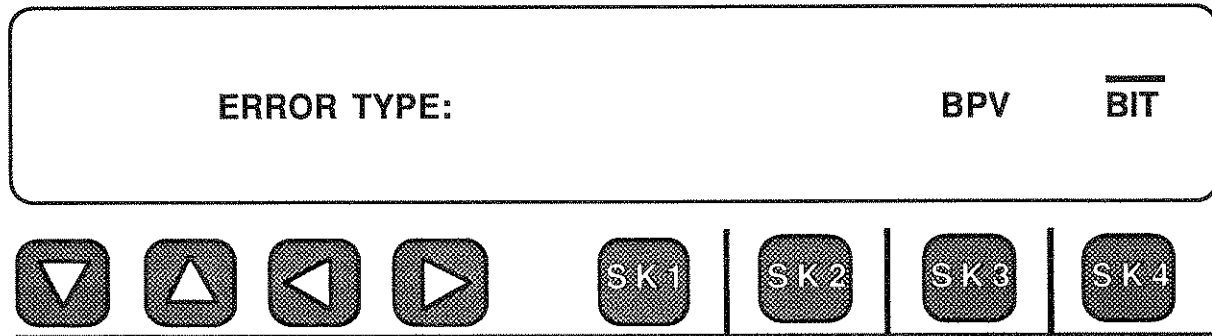

You press the softkey directly beneath the type of error you want to send and the 930A display returns you to the main BERT menu.

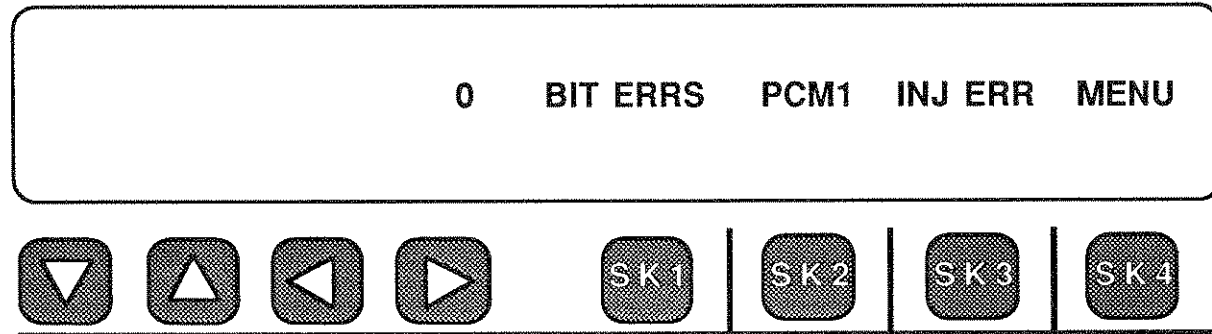

When you press Softkey 3 under **INJ ERR**, the 930A will send the type of error you selected.

Note: Any error counters are lost if you leave Menu Option 46. See Section 5-43.

5-47 TESTING A T-1 AUTOMATIC PROTECTION SWITCH (APS)

The 930A has a built-in APS test located in Menu Option 47: APS TEST. This is included as part of purchased option 930A-08E or -09E. This function is used to test a T-1 Automatic Protection Switch's ability to sense an error rate in excess of its threshold and switch to the standby T-1 span. The test consists of sending a BPV rate slightly below the switch's error threshold for 20 seconds to check for false triggering, then sending a BPV rate slightly above the threshold for 20 seconds to make sure that the protection switching is activated, then sending a BPV rate of one tenth the initial rate to make sure the switch restores the span to normal operation.

To use this feature, perform the following steps:

Press the OPTION MENU  Option Menu function key.

Use the UP/DOWN   arrow keys to select Menu Option 47: APS TEST.

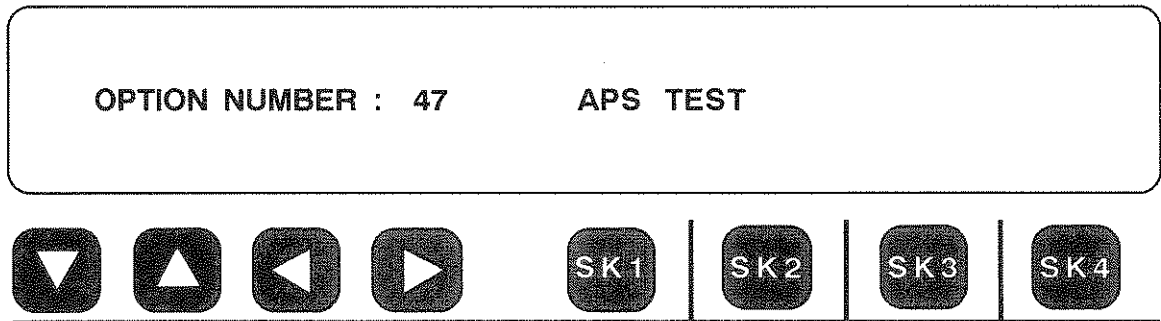

Press any softkey and you will get to the main selection menu:

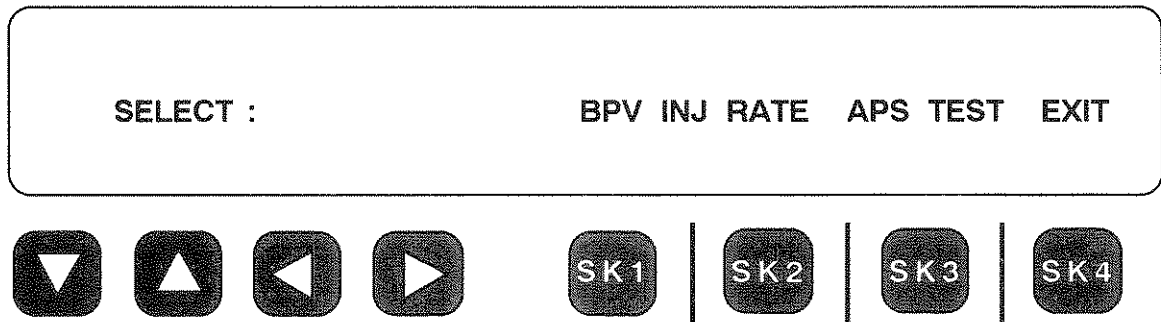

If you just want to send BPV's at a fixed rate, press Softkey 2 under BPV INJ RATE. You will get the SET RATE screen:

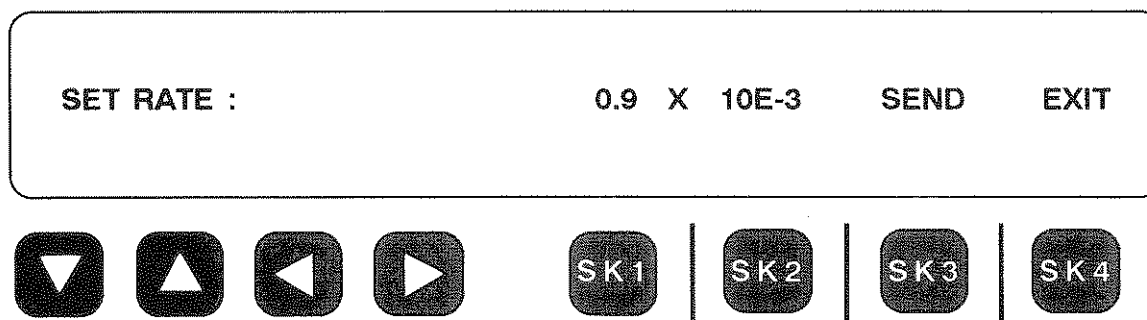

You can select a multiplier of 0.9, 1.0 or 1.1 by pressing Softkey 1 and you can select the rate exponent as 10E-3, 10E-4 or 10E-5. Once you have set the desired BPV rate, press Softkey 3 under SEND and the 930A will begin injecting errors at the selected rate.

To perform an automatic protection switch test, select APS TEST from the main menu above by pressing Softkey 3 under APS TEST. You will be asked to select the desired APS threshold:

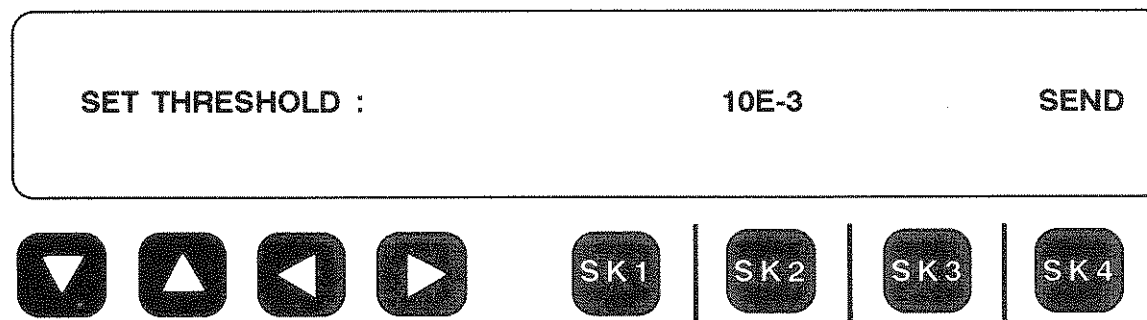

Select either 10E-3, 10E-4 or 10E-5 by pressing Softkey 2. Then press Softkey 4 under SEND and the APS test will begin automatically. The 930A will send BPV's at a rate slightly below the selected threshold for 20 seconds. Then it will send at a rate slightly above the threshold for 20 seconds. Then it will send at a rate of one tenth the initial error rate to see that the switch returns to its normal state.

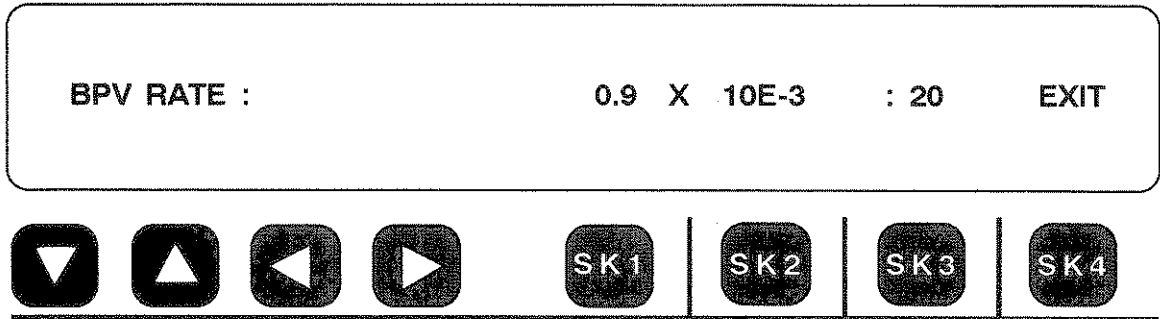

The display will look somewhat like the one above as the 930A runs through the APS test. The seconds are counted down from 20 on the counter above Softkey 3. You can terminate the test at any time by pressing Softkey 4 under EXIT. When the test is finished, the 930A returns you to the main menu.

5-48 CSU EMULATION (MENU OPTION 48)

5-48.1 DESCRIPTION AND OPERATION

If the 930A is used to connect directly to a T-1 Span--that is, not at the DSX or on the Customer side Service Unit (CSU), the 930A must be equipped with Option 44. Option 44, **CSU EMULATION**, adds the special line interface functions necessary to connect directly to a T-1 span.

The major application for CSU emulation is for turnup and maintenance of T1 spans to the customer location. When the Customer Service Unit (CSU) is not installed or it is suspect in a problem, Option 44 allows the 930A to be connected directly to the span without a CSU.

There are four major functions provided by the CSU Emulation option:

- 1) Addition of a automatic Line Build-out (ALBO) circuit to adapt to the levels and frequency response of long spans.
- 2) Selectable transmit line build-out with a output attenuation of 0, 7.5, or 15 db controllable from the front panel of the 930A.
- 3) A Simplex current path between the **IN** and **OUT** jacks with a current measurement function.
- 4) Remote loopback functions, allowing the 930A to respond to In-band loopback codes and perform a line loopback function.

A 930A equipped with Option 44 can still be used at the DSX for full or monitor level signals. All of the 930A's channel access and bit error rate functions are available with any Signal source.

Only the **PCM1** interface is equipped with the CSU Emulator; the Special CSU functions are intended for use only in the **TERMINATE** mode. THRU and Drop and Insert modes are still available when used at the DSX or on the customer side of the CSU.

Select the CSU function with the following:

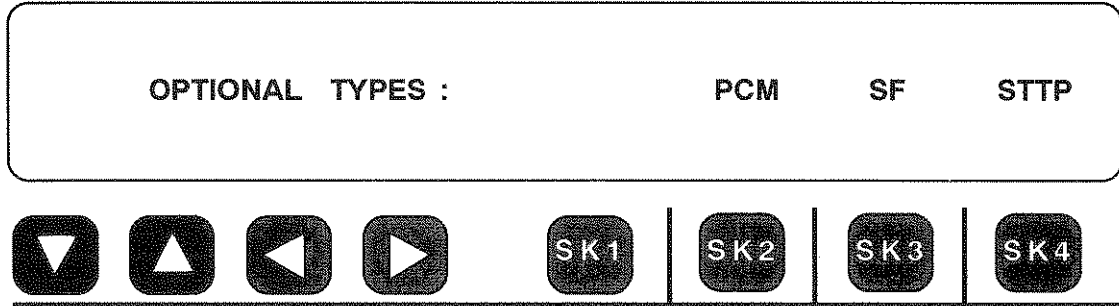

Select **PCM**. The following screen is displayed:

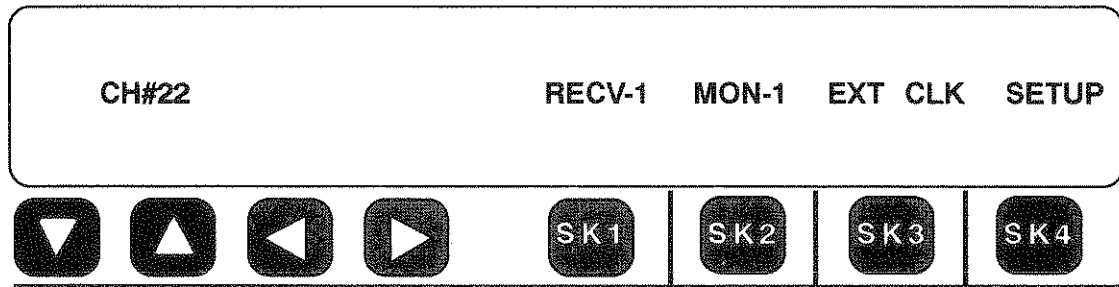

Follow standard setup procedures to configure the T-1 channel or Span for the required configuration. See Section 3 for Connections and configurations.

Press the **OPTION MENU**  **Option Menu** function key.

Select **Option 48** by entering on Numeric pad and pressing **ENTER**.

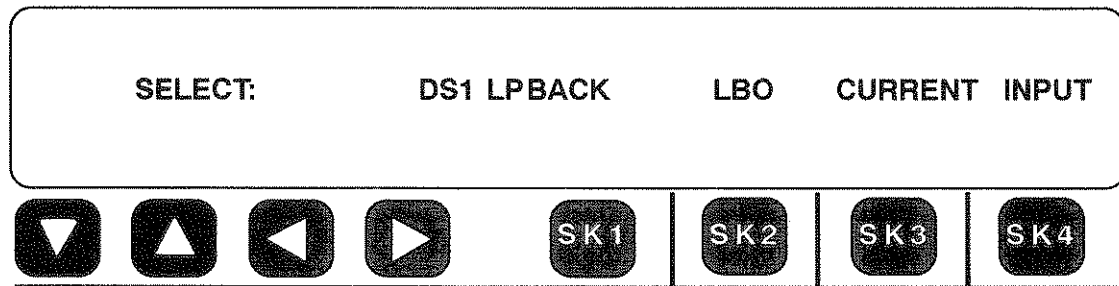

For configuring and setting DS1 Loopback, Select **DS1 LPBACK**. The screen is displayed on next page:

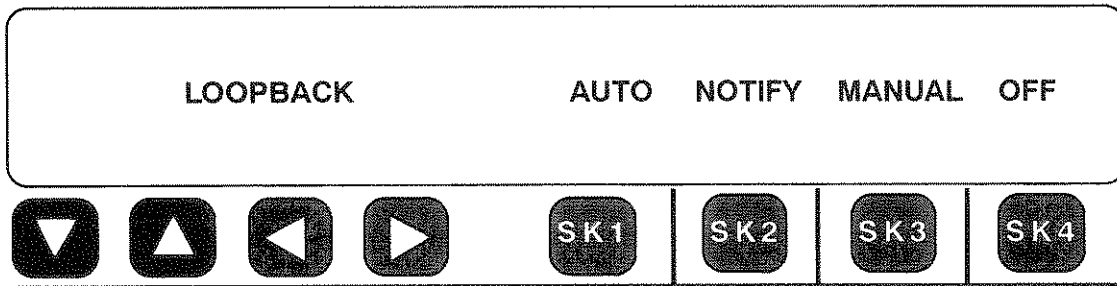

To set the Loopback for Automatic selection, press **AUTO**. The following display occurs:

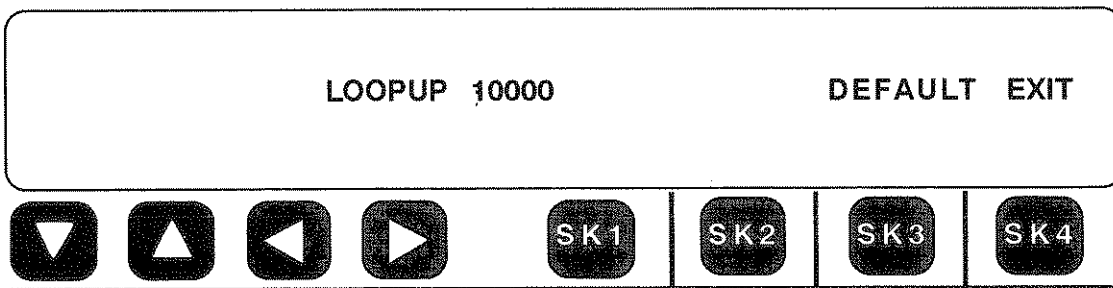

Press **DEFAULT** if you want to keep the standard code. If you need to change the code, enter the new **LOOPUP** code from the keypad. Press **EXIT** when complete. The display will change to:

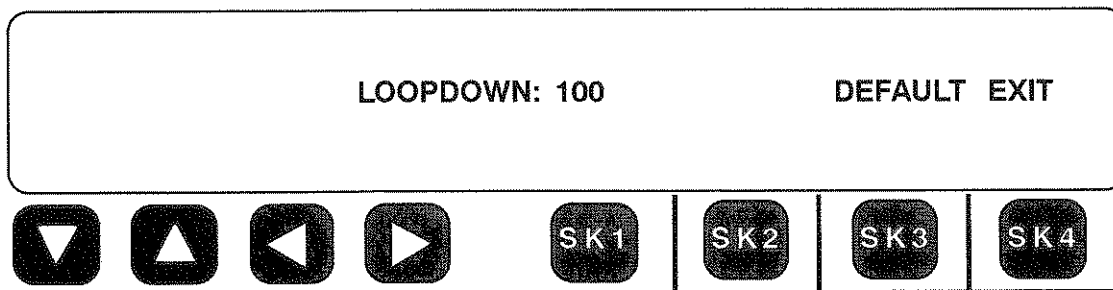

Press **DEFAULT** if you want to keep the standard code. If you need to change the code, enter the new **LOOPDOWN** from the Keypad. Press **EXIT** when complete. The following screen is displayed on next page:

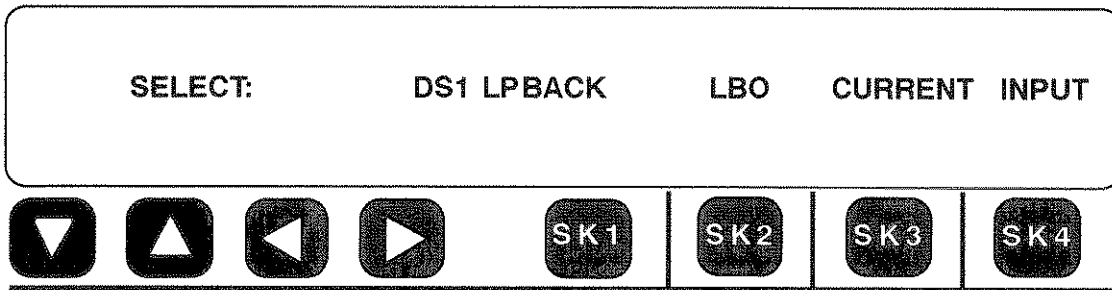

The Auto Loopback is now set. The loopback will occur on the next loopup command from the network. You may also setup a MANUAL loopback which will loop on command. Select **DS1 LPBACK** and the following display will result:

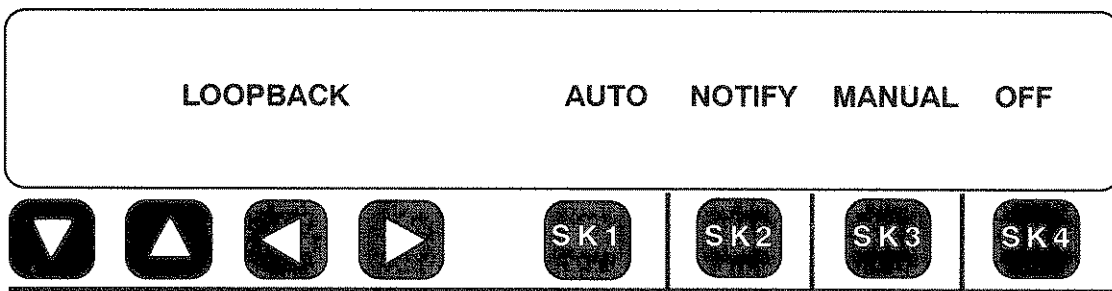

Select the **MANUAL** key. The following will be displayed:

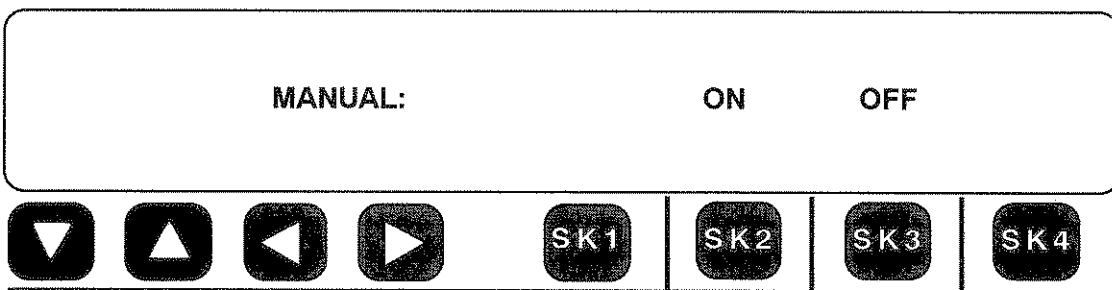

Selecting **ON** or **OFF** will either place the CSU loopback ON or OFF on Command. The following screen is displayed on next page.

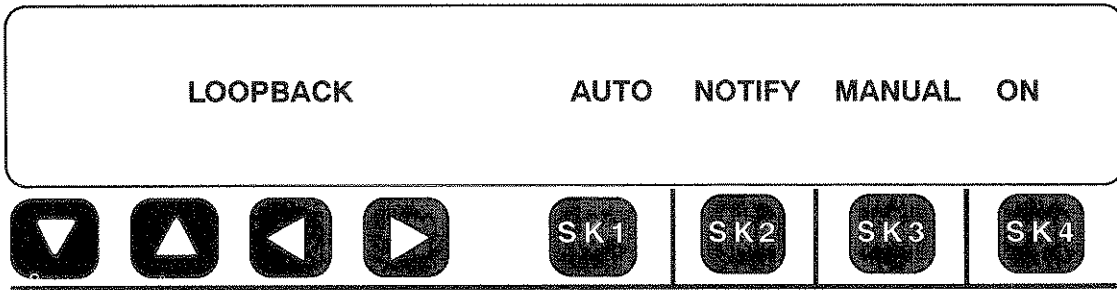

To turn the **MANUAL** loopback off, press Manual, and then **OFF**. The display returns to the **SELECT** menu.

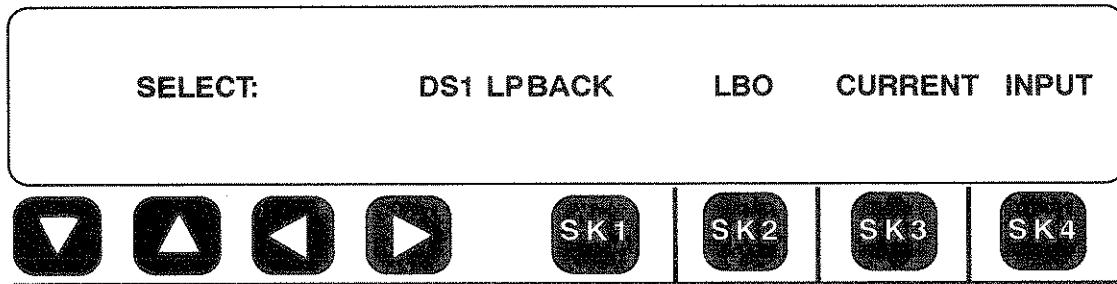

To Option the LBO or Line buildout setting for the 930A CSU, Press **LBO**. The following display is displayed:

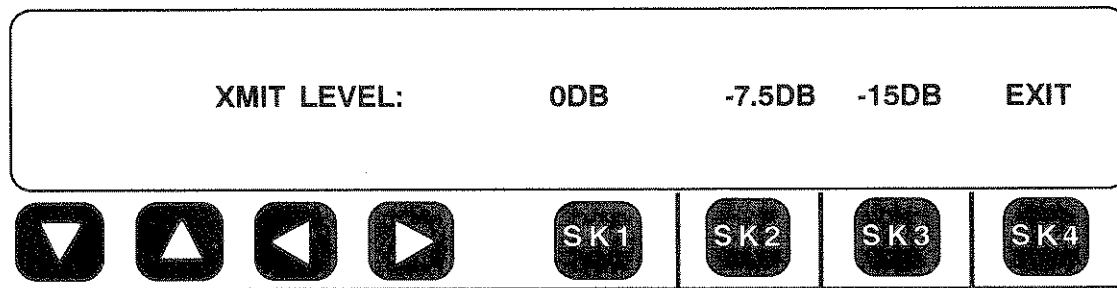

You normally set the **LBO** for the prescribed setting based on the Design criteria furnished or based on the number of feet away from the First Repeater (Max 2500'). This usually is considered close (-15 DB), about half way (-7.5 DB) or Far (0 DB). The default is (0 DB). After pressing the proper Buildout setting, you will return to the **SELECT** screen.

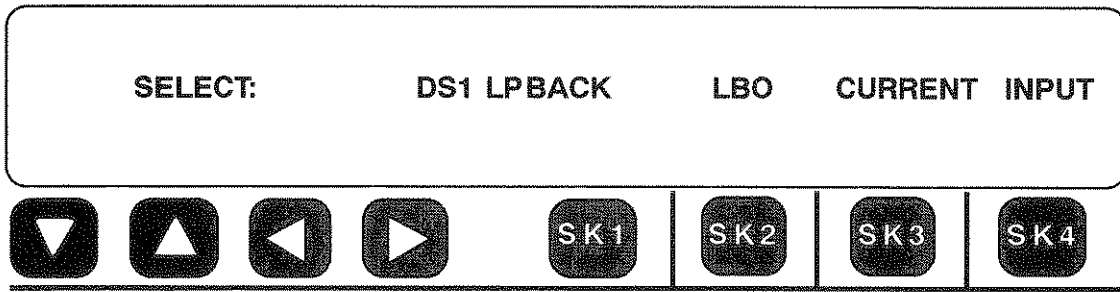

You can measure the Span Current on the T-1 facility by selecting **CURRENT**. This will result in the following display below:

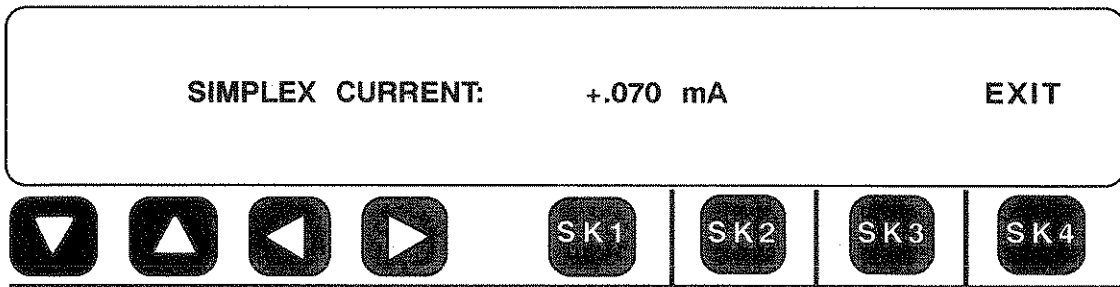

This screen indicates that there is .075mA of current on the **SPAN SIMPLEX**. Press **EXIT**. The following screen is displayed below:

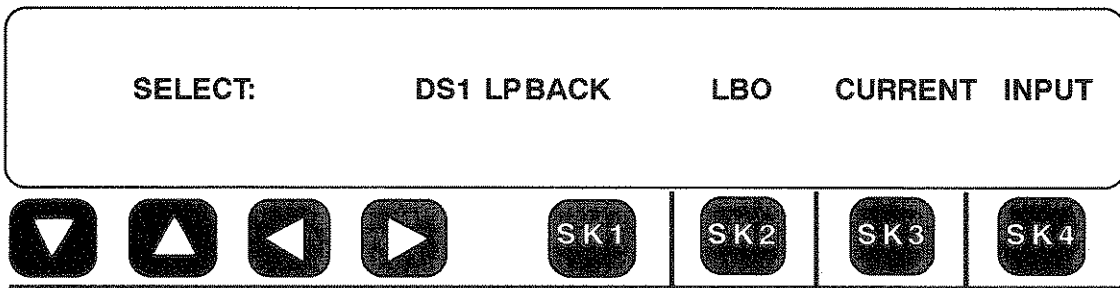

The CSU Emulation feature will also work with DSX or SPAN terminations. Low level signals can still be monitored when required. To change the required T1 interface, select the **INPUT** key. The following display will result:

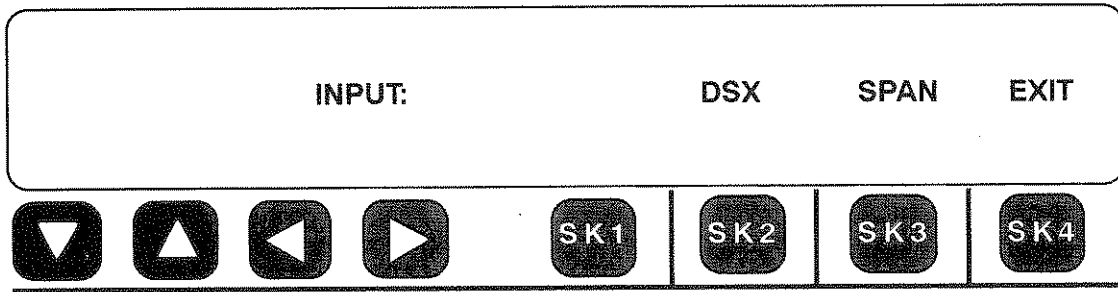

Press either **DSX** for Monitor or **SPAN** for Termination on a T-1 span.

5-50 BATCH MODE TESTING WITH THE 930A (MENU OPTION 50)

Batch Mode allows the user to program the 930A to place multiple calls automatically, beginning at a scheduled time, and to store the results of these calls in memory. The "results" may be call disposition (busy, reorder, etc.), wink timing, or measurements made to a remote test line such as a 105 responder.

Expanded memory (64K RAM Option 930A-32) is not required for Batch Mode, but is strongly recommended. Batch operations can very quickly use up the 39 memory locations that are standard with the 930A. The 64K RAM expansion gives the user 899 memory locations to work with. You must also have Option 930A-10C installed since Batch Mode uses the real-time clock.

You may set up Batch Mode manually, but it is generally more useful under remote control. Using Batch Mode, a single computer can program several 930As to perform automated tests over a network simultaneously. This allows the user to build a powerful but inexpensive automated trunk routing system for private networks. Manual use of Batch Mode is helpful for repetitive tasks such as placing fifty calls to the same test line or placing calls at odd hours when the user would prefer to be asleep.

5-50.1 HOW BATCH MODE WORKS

First, you enter the telephone numbers (using the **DIAL/RING** function) that will be called in Batch Mode and store them into the 930As memory locations.

Once you have entered the telephone numbers, you select **Menu Option 50: BATCH MODE**. This is where you will enter the call sequence. The call sequence tells the 930A how many calls to place, where the telephone numbers are stored and where to store the test results. It also tells the 930A when to pause for dial tone, winks, or other supervision and whether a test line will answer the call.

Once the call sequence is set, you tell the 930A when to begin testing and then press the softkey under **TEST**. When the scheduled time arrives, the 930A will execute the tests and store the results.

5-50.2 BATCH MODE CAPABILITIES AND EXAMPLES

You may place up to 899 calls (with 64K RAM Option 930A-32) in a single batch test. The number of different telephone numbers you may call and the maximum number of test results you may store will depend upon the amount of memory installed in the 930A.

You may specify the testing to begin at any time of day, any day, month or year. If the time and date specified are earlier than the current time, testing will begin immediately.

At any point in the call sequence, or at multiple points, you may pause for one second, pause for dial-tone, pause for a wink, pause for an off-hook from the far end or a delay-dial event.

You may specify that a single telephone number be outpulsed for every call made in batch mode. You will be prompted to tell the 930A where that telephone number has been stored in memory. This is called a fixed # or an unchanging telephone #. A single call sequence may include up to four fixed numbers. If you wished to place fifty calls to the same test line, for example, you would store the telephone number of the test line in 930A memory, program batch mode for fifty calls to a fixed #, and give the memory location in which you had stored the test line's telephone number.

You may have the 930A outpulse a different telephone number for every call made in batch mode, provided that these numbers have been stored into sequential memory locations in the 930A. This is called a **BATCH** of telephone numbers. You will be prompted to tell the 930A the memory location of the first number. The 930A will dial the number stored in that memory location when it places the first call in batch mode. On the second call, it will dial the number stored in the next register location. It will continue to increment the memory location for every call it places in batch mode. Suppose, for example, that you wished to test ten different circuits, each of which could be accessed by dialing a specific sequence of digits into your test port. You would store the access digits for the first circuit into a 930A memory location, such as location 1. You would then store the digits for the second circuit in register 2 and so on.

This is done by pressing the **DIAL/RING** function key, entering the access digits, pressing the **STO** key and entering the number of the memory location. You would then press the **OPTION MENU** function key, go to Menu 50, enter Batch Mode and program the 930A to place ten calls, select a **BATCH** and give a location of the first access digits (Location 1 in this example).

You can mix batches of changing and unchanging (fixed) telephone numbers in a single call sequence. You may program the 930A to expect a test line to answer the call. You may further program the 930A to expect a 100, 102, 105 or 125 test line. A type 100 test line provides quiet termination for noise measurements. A 102 test line provides milliwatt tone. It may be continuous or intermittent. A 105 test line is a CAROT compatible responder which includes the SAGE Model 356E Voice/Data responder or a 930A acting as a far end responder. A 125 test line is an HLI type 115 or 125 transponder (not CAROT compatible). When setting up the call sequence in batch mode, select **TESTLINE**, then select 102, 105 or 125 as appropriate.

The tests which will be performed will depend upon the type of test line selected. When testing to a type 100 test line you may measure C-Message noise or 3 KHz noise. When testing to a type 102 test line you can measure one-way loss, C-Notch noise, and signal-to-noise ratio. These tests are selected in **Menu Option 29: CALL 102 LINE**. When testing to a standard 105 test line, you can choose to test two-way loss, gain/slope, C-Message and C-Notch noise, and/or return loss (ERL, SRL and/or SRH). If the responder is a SAGE Model 356E, you may additionally test two-way attenuation distortion, signal-to-noise ratio, 3 KHz Flat noise, P/AR, Intermodulation distortion, phase and amplitude jitter (20 to 300 Hz and/or 4 to 300 Hz bands), envelope delay distortion, and/or impulse noise and hits. These tests are selected in **Menu Option 26: ROTL/RESPONDER**. When testing to a 125 or a 115 test line, you may select two-way loss, gain/slope and/or C-Message and C-Notch noise tests. These tests are selected in **Menu Option 28: TRANSPONDER TEST**.

You may instruct the 930A to remain on-hook for a specific duration between calls made in batch mode. You may select an on-hook interval of 10 to 9999 milliseconds in 10 millisecond increments.

5-50.3 KEY FUNCTIONS IN BATCH MODE

In this section, the operation of the front panel keys in batch mode will be outlined. To begin,

Press the OPTION MENU  Option Menu function key.

Use the UP/DOWN   arrow keys to select Menu Option 50: BATCH MODE.

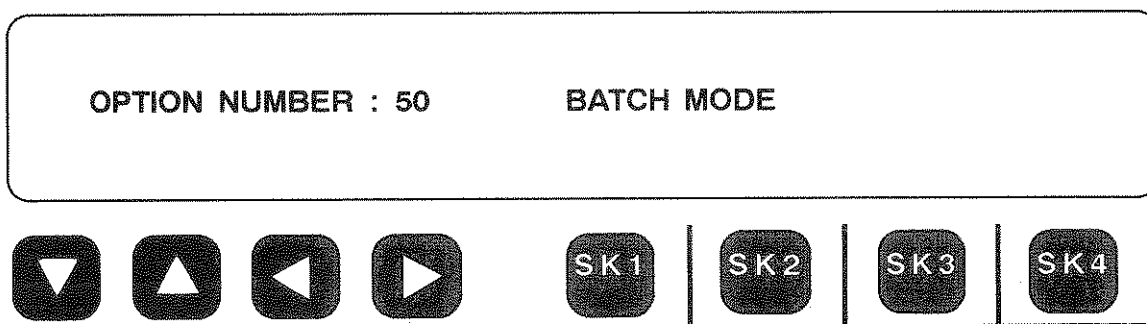

Press any softkey under the display to bring up the main select menu.

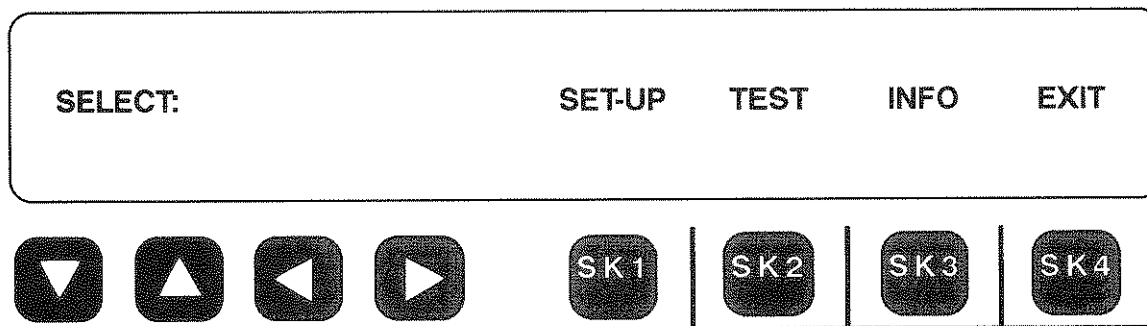

To set up BATCH MODE, press Softkey 1 under SET-UP. The following display will appear:

Softkey 2 is labeled "ROLL -> ". It is a wheel which allows you to select the next item in the call sequence. It begins with **WINK**. By pressing Softkey 2, under "ROLL -> ", you can select **OFF-HK, DELAY, PAUSE, FIXED #, BATCH, TESTLINE** or **DIALTONE**.

The **UP/DOWN** arrow keys can also be used to scroll through the choices on the wheel.

Whenever Softkey 2 or the arrow keys are pressed, the display over Softkey 3 changes. Again, it may show **WINK, OFF-HK, DELAY, PAUSE, FIXED #, BATCH, TESTLINE** or **DIALTONE**.

Pressing Softkey 3 will enter whatever is shown above the softkey into the call sequence. A letter or a letter and number representing the event will be added to the sequence and displayed on the left half of the screen. After any selection is entered, the word "WINK" will reappear over Softkey 3. A full sequence might look like:

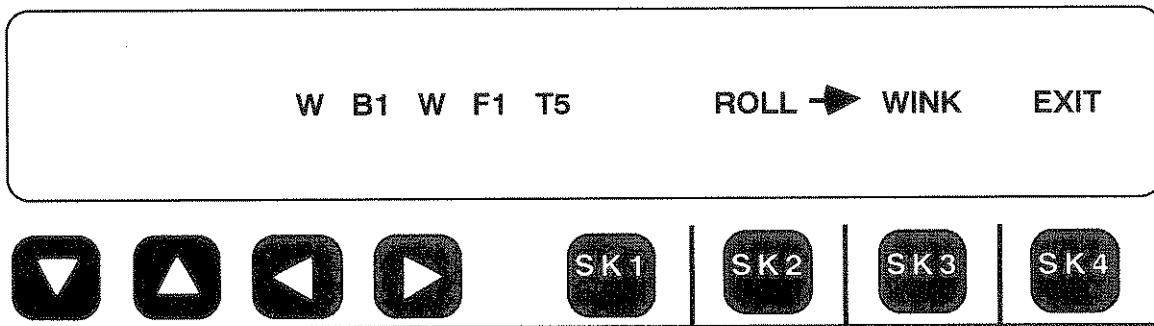

5-50.4 POSSIBLE EVENTS IN THE CALL SEQUENCE

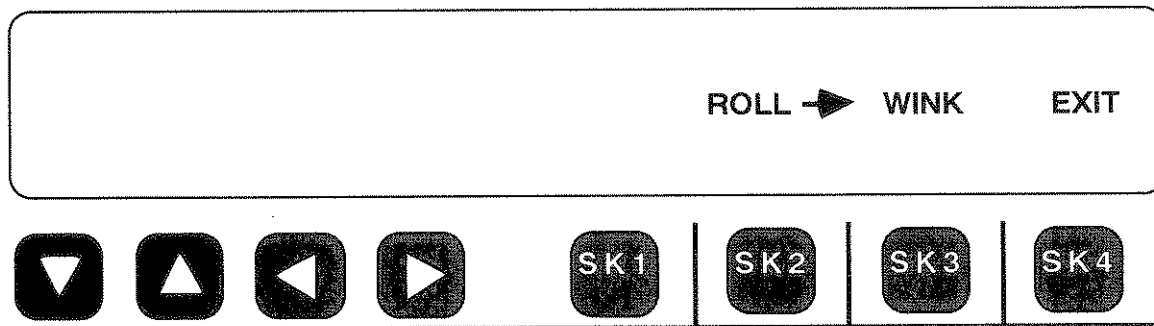

Pressing Softkey 3 when the word "WINK" is displayed above it causes the letter "W" to appear in the sequence.

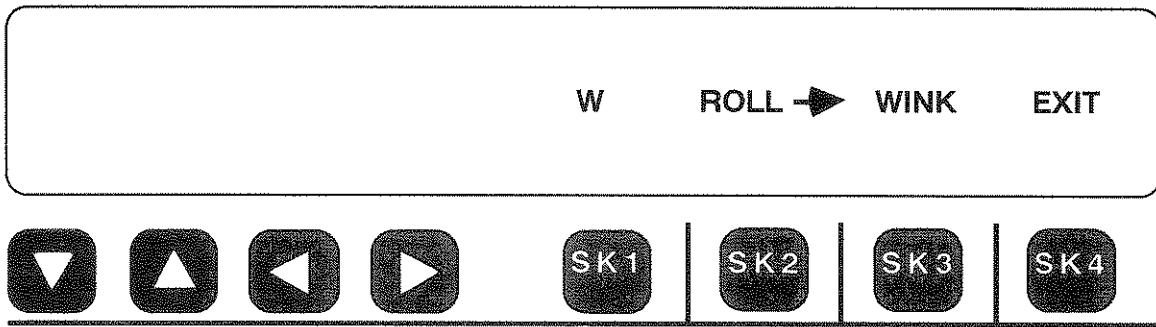

When testing in the batch mode, a "W" causes the 930A to wait for a wink from the far end before proceeding. The length of the wink and the time spent waiting for it will be recorded in **Menu Option 9: WINK TIMING**. If no test line is specified at the end of the call sequence, the wink timing information will also be recorded in **Menu Option 51: TEST RESULTS**.

Pressing Softkey 3 when the word "OFF-HK" is displayed above it causes the letter "H" to appear in the sequence.

ROLL -> OFF-HK EXIT

H ROLL -> WINK EXIT

After the "H" has been entered the display reverts back to showing WINK over Softkey 3. When testing in batch mode, an "H" causes the 930A to wait for the far end to go off-hook before proceeding. The length of time spent waiting for the off hook and the length of the off hook (up to 200 Milliseconds) will be recorded in **Menu Option 9: WINK TIMING**. If no test line is specified at the end of the call sequence, then this information will be recorded in **Menu Option 51: TEST RESULTS**.

Pressing Softkey 3 when the word "DELAY" is displayed above it causes the letter "D" to appear in the sequence.

ROLL -> DELAY EXIT

D ROLL -> WINK EXIT





When testing in batch mode, a "D" causes the 930A to wait for the far end to provide a delay dial event before proceeding. The length of time spent waiting for the event and the length of the event will be recorded in **Menu Option 9: WINK TIMING**. If no test line is specified at the end of the call sequence then this information will also be recorded in **Menu Option 51: TEST RESULTS**.

Pressing Softkey 3 when the word "PAUSE" is displayed above it causes the character "-" to appear in the sequence.

ROLL -> PAUSE EXIT
- ROLL -> WINK EXIT

When testing in batch mode, a "-" causes the 930A to wait for one second before proceeding.

Pressing Softkey 3 when the word "FIXED #" is displayed above it causes the 930A to prompt the user:

| | | | | | | | |
|---|---|---|---|------|------|------|------|
| ENTER LOCATION OF UNCHANGING TEL # : | | | | 1 | | | |
|  |  |  |  | SK 1 | SK 2 | SK 3 | SK 4 |

Use the numeric keypad to enter the number of the memory location where the telephone number is stored and then press the **ENT** key. The letter "F", followed by a "1", "2", "3" or "4" will be inserted into the call sequence. The 930A can have up to four fixed numbers in a call sequence.

ROLL -> FIXED # EXIT
F1 ROLL -> WINK EXIT

When testing in batch mode, a "F" causes the 930A to recall a telephone number stored in memory and dial it. The same number will be recalled and dialed each time. You may use up to four fixed numbers in a sequence. Use the **DIAL/RING** function to enter the telephone number into the 930A and then press the **STO** key to store it into a memory location. This should be done **BEFORE** setting up the sequence in **BATCH MODE**.

Pressing Softkey 3 when the word "**BATCH**" is displayed above it causes the 930A to prompt the user:

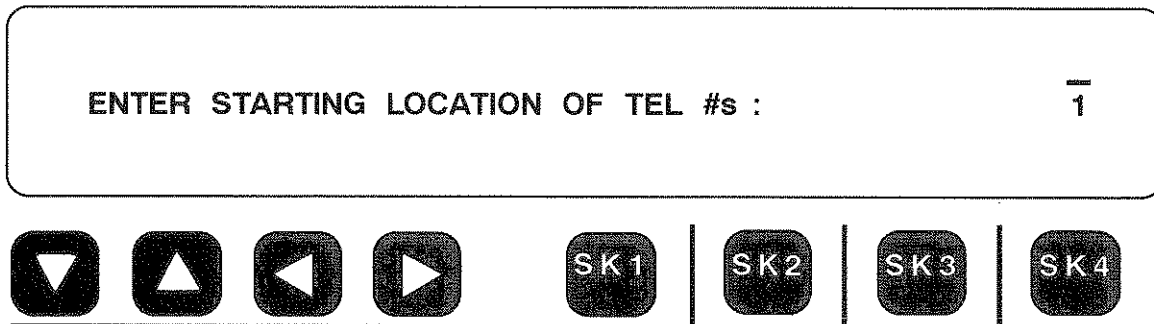

Use the numeric keypad to enter the number of the memory location where the first telephone number is stored and then press the **ENT** key. The letter "**B**", followed by a "1", "2", "3" or "4" will be inserted into the call sequence.

ROLL -> BATCH EXIT

B1 ROLL -> WINK EXIT

When testing in batch mode, a "**B**" causes the 930A to recall a telephone number stored in memory and dial it. The memory location will be incremented each time the 930A places a call. You must have telephone numbers stored in sequential memory locations beginning at the **STARTING LOCATION** you were prompted for. You must have as many numbers stored as you programmed **BATCH MODE** to test (i.e., if you input "4" as the "**NUMBER OF TRUNKS TO TEST**", and "1" as the "**STARTING LOCATION OF TEL #s**", you must have numbers stored into locations 1, 2, 3 and 4). You may use up to four batches in a sequence. Use the **DIAL/RING** function to enter the telephone numbers into the 930A and then press the **STO** key to store them into sequential memory locations. This should be done **BEFORE** setting up the sequence in **BATCH MODE**.

If you have not purchased Option 930A-32 64K RAM Expansion, you will have only 39 memory locations in the test set. This is the maximum number of sequential telephone numbers you can store. Option 930A-32 expands this number to 1000.

Pressing Softkey 3 when the word "TESTLINE" is displayed above it causes the 930A to prompt the user:

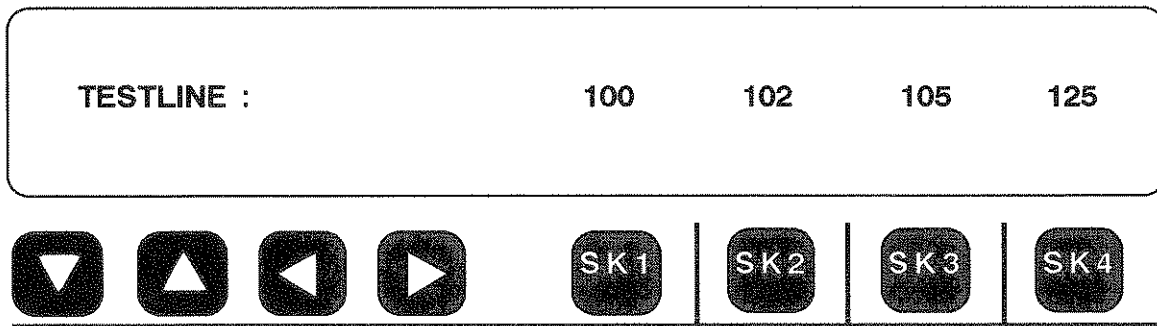

Use the softkeys to select a type 100, 102, 105 or 125 test line. A "T0", "T2", "T5" or "T1" will be inserted into the call sequence. For example if you press Softkey 3 under 105, the display will change from:

ROLL -> TESTLINE EXIT

to

T5 ROLL -> WINK EXIT

When testing in batch mode, a "T" causes the 930A to expect a test line to answer the telephone. If the "T" is followed by a "0", the 930A expects a type 100 test line (Quiet Termination). If the "T" is followed by a "2", the 930A expects a type 102 test line (milliwatt). If the "T" is followed by a "5", the 930A expects a type 105 test line (52A responder, SAGE 356E responder or another 930A acting as a far end responder). If the "T" is followed by a "1", the 930A expects a type 115 or 125 HLI transponder.

The 930A will wait for the characteristic test progress tone sent by the specified test line. If it detects busy, reorder, dial-tone or some other continuous tone, it will record the network response time and call completion status and proceed with the next call. If the expected tone is not received within 60 seconds, the current status of the line will be recorded (dead line, ringing -- no answer or speech) and the 930A will proceed with the next call.

If the 930A receives the expected tone within 60 seconds, it will record the call completion time (from the end of the last event to receipt of the test tone) and perform any selected tests.

Tests to type 102 lines are selected in **Menu Option 29: CALL 102 LINE**. This is detailed in Section 5-29. Tests to type 105 test lines are selected in **Menu Option 26: ROTL/RESPONDER**. Details of using this menu option are contained in Section 5-26. Tests to type 115 or 125 transponders are selected in **Menu Option 28: TRANSPONDER TEST**. This menu option is explained in Section 5-28.

The same set of tests will be performed on each trunk tested in batch mode.

The test results (or call completion status and timing) will be stored in **Menu Option 51: TEST RESULTS**. This information supersedes any wink timing information that might otherwise have been stored in **TEST RESULTS**. More information on storing and retrieving test results is provided later in this section.

When the 930A encounters a "T" during batch testing, it goes on to the next call after the test line answers and tests have been performed or fails to answer. Anything in the sequence after a test line is ignored.

Pressing Softkey 3 when the word "DIALTONE" is displayed above it causes the letter "-" to appear in the sequence.

ROLL -> DIALTONE EXIT

d ROLL -> WINK EXIT

When testing in batch mode, a "d" causes the 930A to pause for dial tone before proceeding.

5-50.5 BATCH MODE EXAMPLE

Suppose you wish to test five telephone circuits in batch mode. For each call, you want the 930A to go off hook, wait for a wink, dial the access code for one of the circuits, wait for another wink and then dial the number of a 105 test line.

First, you would use the **DIAL/RING** function to enter the access codes for the five circuits, using the **STO** key to store the codes in five sequential memory locations (locations 1, 2, 3, 4 and 5, for example). Next, you would use the **DIAL/RING** function to enter the telephone number of the 105 responder. You would then store this number in memory location 6, in this example, using the **STO** key. Then you would enter **Menu Option 26: ROTL/RESPONDER** and select the tests that you want performed when the 105 responder is reached.

Once these steps are performed, you would go to **Menu Option 50: BATCH MODE**, press the softkey labeled "**SET-UP**", select "**CALL SEQUENCE**", answer "**5**" when prompted for the number of trunks to test, and enter the following sequence (you will see this display first):

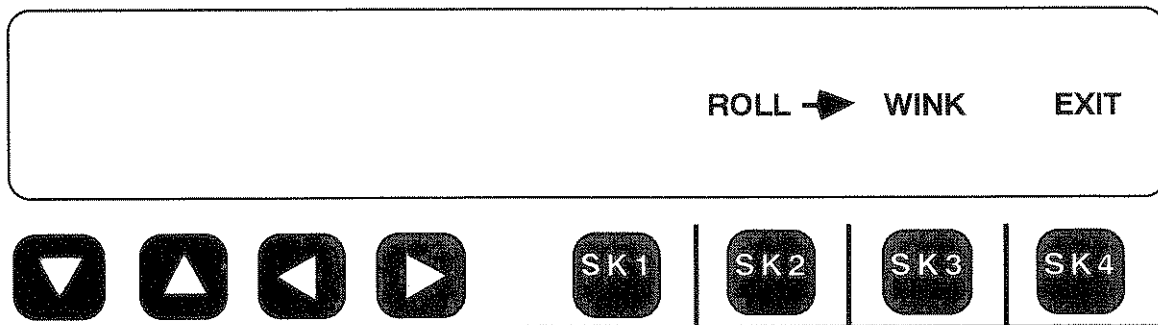

Press Softkey 3 and you will see this display:

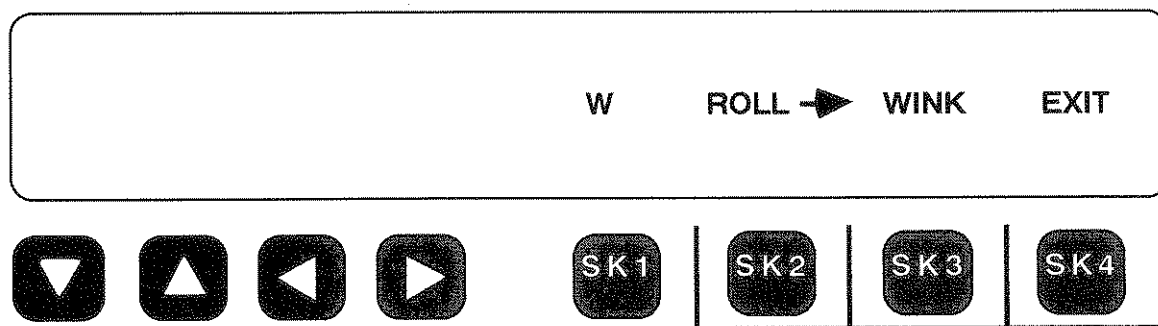

Press SK2 **ROLL** to select Batch #1. Scroll until **BATCH** is displayed and then press **BATCH**. Then press SK2 **ROLL** again until **TESTLINE** scrolls up, Press **TESTLINE** and press SK3 **105**. The following screen will display:

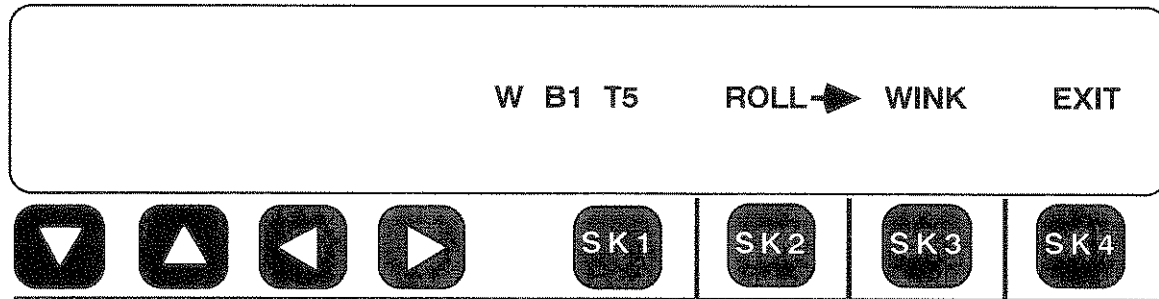

You are now ready to proceed to testing under Batch Mode.

5-50.6 TESTING USING BATCH MODE

Once you have set up the call sequence and test time, and stored any necessary telephone numbers into memory, you are ready to begin batch testing. Press Softkey 2 under **TEST** in the main menu. You will see a display much like:

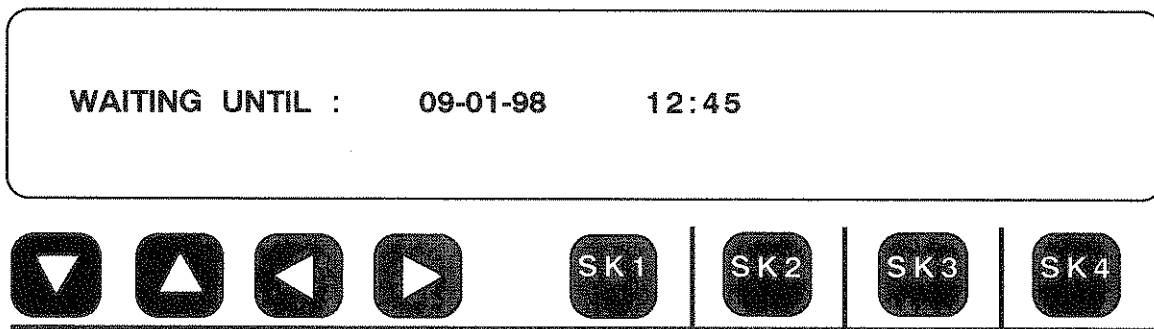

This display will remain on the screen until the current time and date are equal to or later than the displayed time and date. Once this occurs, testing will begin. Press any function key to abort batch testing at this time.

When testing commences, you will see a display such as:

5-51 STORING TEST RESULTS (MENU OPTION 51)

When the desired sequence has been set up and displayed as shown, press Softkey 4 under **EXIT**. You will see the following display:

| | | | | | | | |
|--------------------------------------|---|---|---|-----|-----|-----|-----|
| ENTER STARTING LOCATION OF RESULTS : | | | | 7 | | | |
| ▼ | ▲ | ◀ | ▶ | SK1 | SK2 | SK3 | SK4 |

Enter the number of the memory location where you would like the results of the first call to be stored. Subsequent results will be stored into sequential locations. If you are testing five trunks, for example, and begin storing test results in location 10, test results for the first trunk will be in location 10, results for the second trunk will be in location 11, and so on. These results are recalled once batch testing is complete by using the **RCL** and **RCL NXT** keys. More information about recalling test results is contained in the following paragraphs. If your 930A is in **PRINTER** remote mode, test results will be sent to the printer at the end of each call.

If you do not have enough memory locations to store both the telephone numbers to be dialed and the test results, you may reuse memory locations during a batch test. If you specified a "1" as the location to begin storing results in the above example, the results of the first trunk tested would be stored in location 1 overwriting the trunk access code which was formerly stored there. Each subsequent test would overwrite the next location with the results of the next test. Naturally you would have to recall the test results and re-enter the access numbers before running the batch test again. This kind of memory manipulation should only be used as a last resort, as it easily leads to overwriting memory locations you may not intend to overwrite. If the 930A recalls a location that it expects to hold a telephone number, and something else is stored there, the test fails with the result:

ABORT: NOT DIGIT RECORD

The 930A then proceeds with the next call.

To set up the 930A to store test results, do the following:

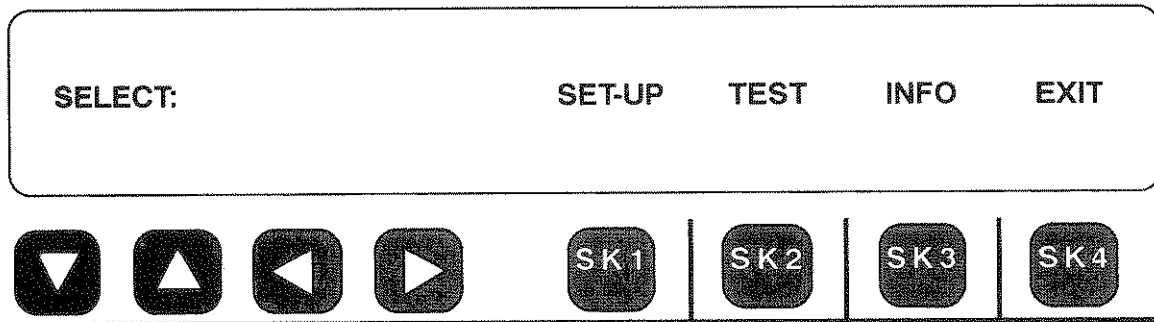

Press Softkey 1 under **SET-UP** and you will see the display:

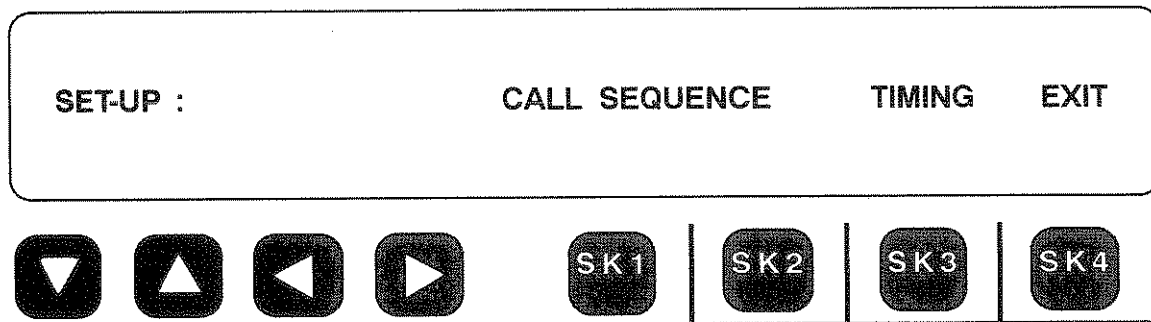

Press Softkey 3 under **TIMING** and you will be prompted:

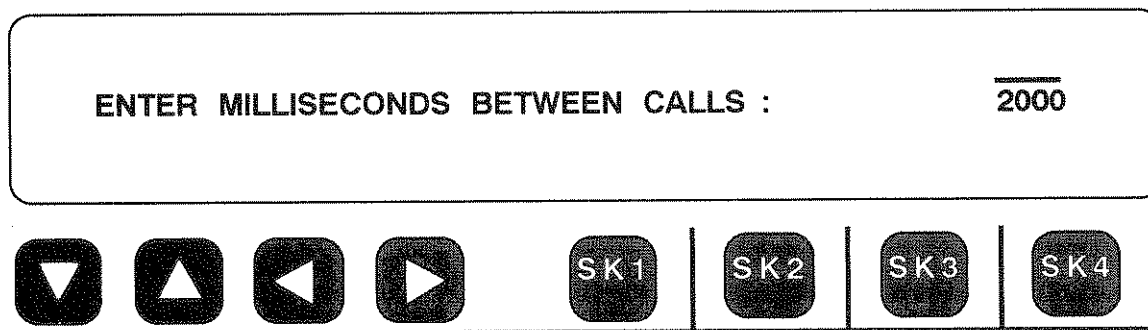

Use the numeric keypad to enter the number of milliseconds the 930A should remain on hook between calls. The valid range is 10 to 9999 in 10 millisecond increments. Invalid entries will be rounded to the nearest 10 milliseconds. Press the **ENT** key when the number is correct.

The display will advance to appear like:

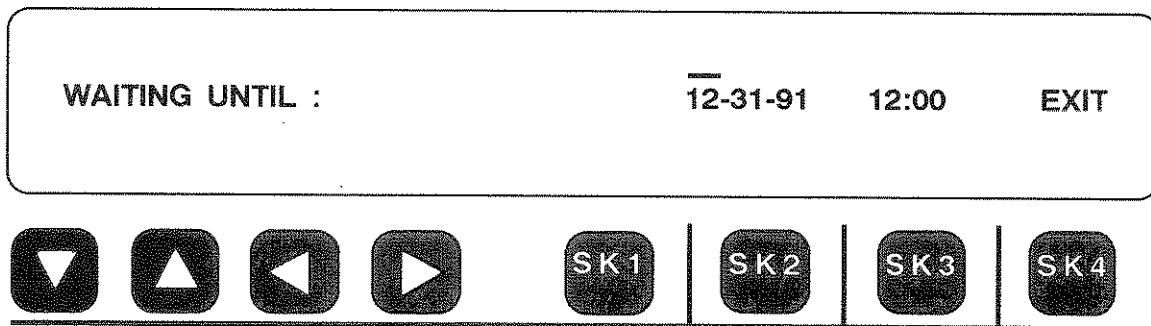

This shows the time and date when the 930A is scheduled to begin its next batch test. You may change it to any time and date you like. If it is set to a time or date previous to the present, testing will begin immediately when you press the softkey under **TEST** in the main select menu.

The **UP/DOWN** arrow keys increment and decrement the value of the highlighted field. Months can be rolled from 0 to 12, days can be rolled from 1 to 31, years can be rolled from 0 to 99, hours from 0 to 23, and minutes from 0 to 59.

The **LEFT/RIGHT** arrow keys move the highlight cursor from field to field. The fields are arranged MM-DD-YY HH:mm, where MM is the month, DD is the day, YY is the year, HH is the hour and mm is minutes. Hours are in the twenty four hour, or military, format.

You may use the numeric keypad to directly enter a number into the highlighted field. When you enter a number directly and press the **ENT** key, the highlight cursor automatically advances to the next field.

When the time and date shown correspond to the starting time for batch testing, press Softkey 4 under **EXIT**. The **SET-UP** menu will be displayed:

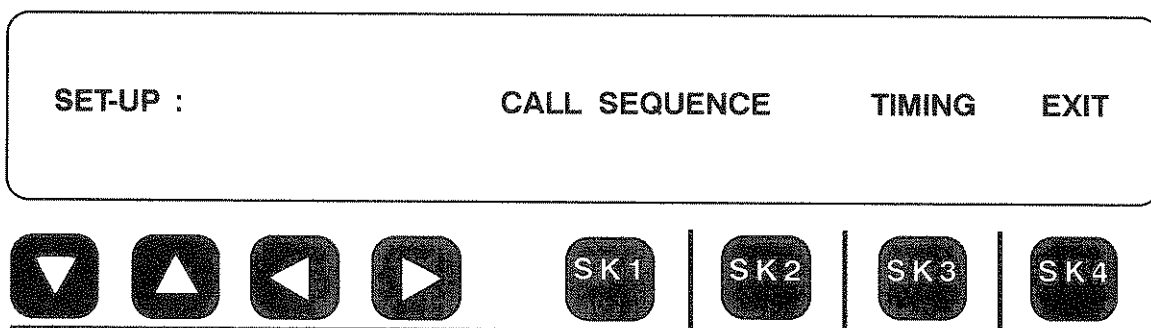

Set-up is now complete. Press Softkey 4 under **EXIT**. The main menu will be displayed:

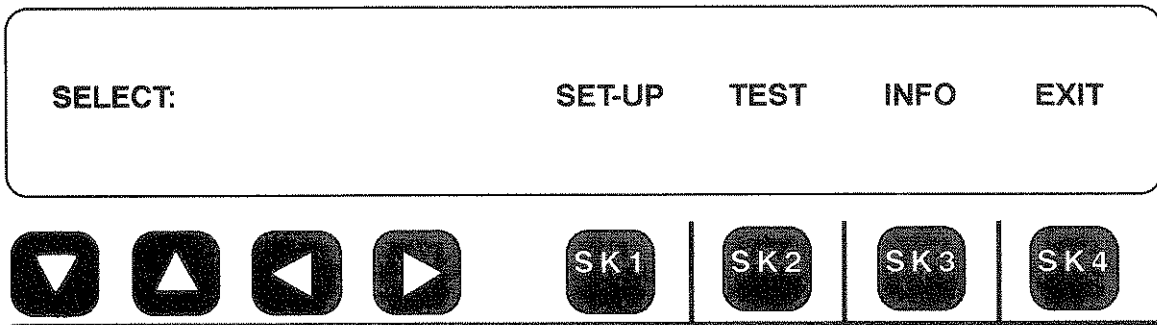

Press Softkey 2 under **TEST** to begin testing at the time selected.

5-51.1 HOW TO CHECK THE SET-UP INFORMATION

To check a set-up without re-entering it, press Softkey 3 under **INFO** in the display above. You will see a display such as:

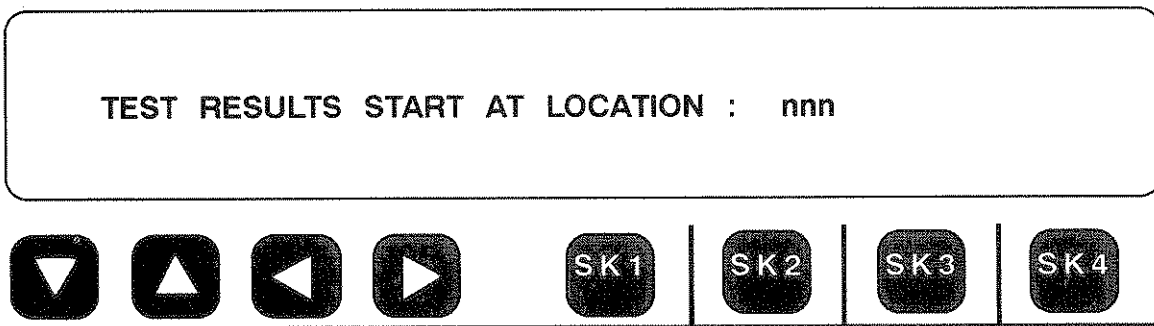

Test results for this batch test will be stored beginning at the location nnn. There will be one set of results for each trunk tested. Test results are stored in sequential memory locations.

Press any softkey. The display will advance to show:

BATCH NUMBER 1 STARTS AT LOCATION : nnn



The first batch of telephone numbers in the call sequence is stored beginning at location nnn. If there are no batches of telephone numbers in the call sequence, this screen will not appear. If there is more than one batch in the sequence, pressing any softkey will bring up a screen showing the starting location of each one in succession. The sequence may contain up to four batches.

Press any softkey and the display will advance to show:

FIXED NUMBER 1 STARTS AT LOCATION : nnn



The first fixed telephone number in the call sequence is stored beginning at location nnn. If there are no fixed telephone numbers in the call sequence, this screen will not be displayed. If there is more than one fixed number in the sequence, pressing any softkey will bring up a screen showing the starting location of each one in succession. The sequence may contain up to four fixed numbers.

Press any softkey. The display will advance to show:

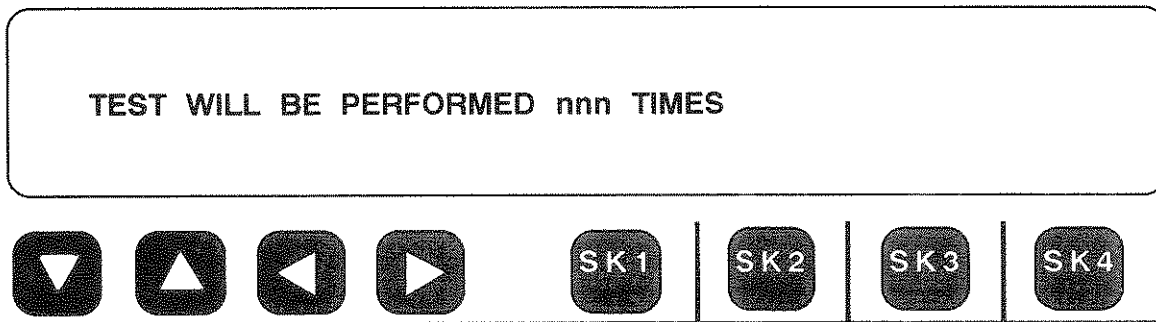

The batch test is set to place nnn calls. If a batch location is part of the sequence, nnn consecutive memory locations must contain telephone numbers for the tests to complete. A total of nnn memory locations will be used to store the test results.

Press any softkey and the display will return to the main menu:

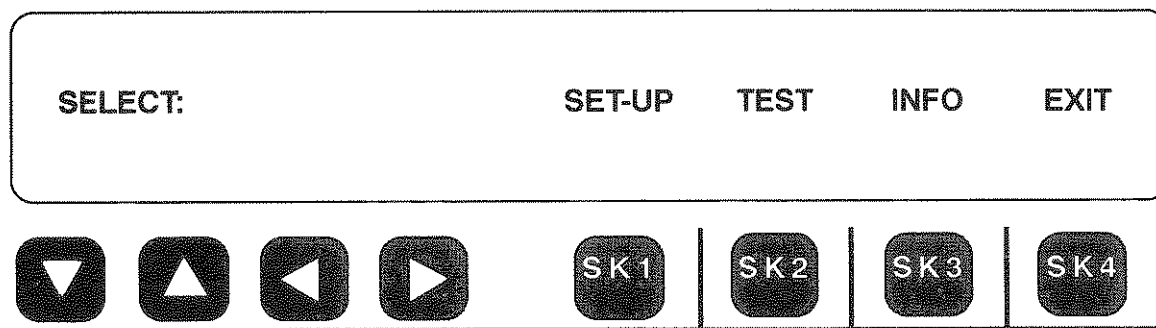

5-51.2 STORING AND RECALLING TEST RESULTS

Each call placed in batch mode generates a set of test results. Each set of test results is stored in one of the 930As memory locations. If you have the 64K RAM expansion installed, there are 999 memory locations. The non-expanded 930A has 39 memory locations.

The test results from the first call placed in batch mode are stored in the memory location specified by the user. Results from each subsequent call are stored in the next sequential memory location. For example, if the user tells the 930A to store test results beginning in location 10, the results from the first call are stored in location 10. The results from the second call are stored in location 11 and so on.

When the 930A stores something into a memory location, it overwrites whatever was there previously. The contents of memory locations are stored in battery-backed CMOS RAM and will not be erased by turning off the 930A. You may collect data in the 930A, turn it off, move it to another location, then recall and display the data. Memory contents will remain unchanged unless they are overwritten with new data.

To recall stored test results, use the **RCL** key. To recall test results stored in location 10 for example, press **RCL**, **1**, **0** and **ENT**. This recalls the contents of location 10. To recall the contents of the next sequential register all you have to do is press the **RCL NXT** key.

Whenever you recall batch mode test results, you will see the following display:

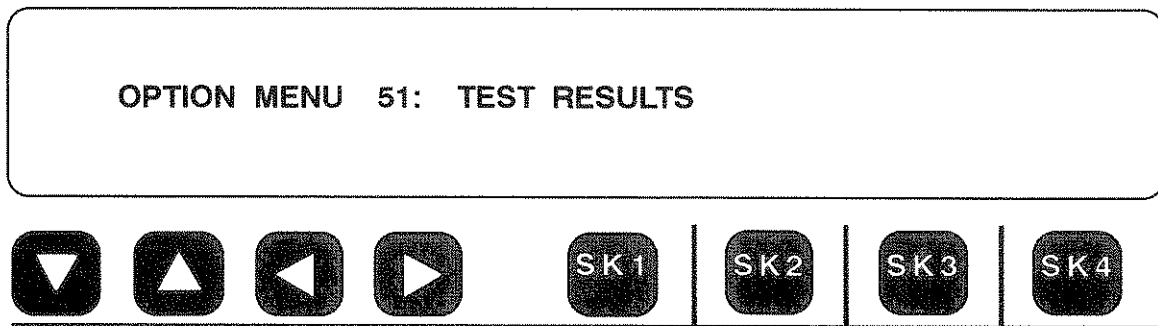

Press any softkey under the display to enter the option menu and examine the results. When you are through inspecting the results, press the **OPTION MENU** key to return to the Option Menu display above. You may then use the **RCL NXT** key to recall the next set of test results.

Since the 930A can be programmed to place a wide variety of calls in batch mode, with many possible results, the contents of Option Menu 51 may vary.

Possible test results are:

DIGITS SENT SUCCESSFULLY

The call was dialed. No winks were timed. No test line was specified.

ABORT: NOT DIGIT RECORD!

One of the memory locations specified as the location of a telephone number did not contain a telephone number. The call failed.

W B1 H WINK 310 MSEC (or a similar display)

A pause for a wink, delay-dial event or an off-hook was specified in the call sequence. No test line was specified, so the highest priority information is wink timing. The call sequence is shown and wink timing information is recorded. See Section 3-10.7 of the manual for wink timing displays and information. If both winks and a test line are specified as part of the call sequence, the wink timing information will be recorded only if a wink fails and the call sequence aborts before the test line can be reached.

ABORT: REORDER 1.7 SECONDS

A test line was specified in the call sequence. The call proceeded to the point where the test line was expected to answer. The call failed to complete. The network response time and call completion status are recorded. The possible call completion states are: **ABORT: REORDER**, **ABORT: DEAD LINE**, **ABORT: RINGING (no answer after 60 seconds)**, **ABORT: DIALTONE**, **ABORT: SPEECH?** and **ABORT: TONE (a continuous tone other than that provided by the expected test line)**.

CALL COMPLETE: 3.7 SECONDS

A test line was specified in the call sequence. The call completed successfully. The call completion time is recorded. If any tests were selected, such as loss or C-Notch noise, their results follow. The exact test results will depend on the type of test line and the tests selected.

If the 930A is in **COMPUTER** remote mode, a bell will be sent to the host computer when any of these test results are recalled and Menu Option 51 is entered. Sending a "W" to the 930A will cause the 930A to send a report to the computer. Sending an "X" to the 930A will cause it to echo its display to the computer. Either method can be used to obtain test results.

If a call sequence includes both a pause for winks (or an off-hook or delay-dial event) and a far end test line, the call completion time and far end test line results will overwrite the wink timing information in **Option Menu 51: TEST RESULTS**. Wink timing for the last trunk tested is available in **Option Menu 9: WINK TIMING**. Wink timing information will only be shown in **TEST RESULTS** if there is no test line specified or the test line could not be reached because an expected supervision event failed.

If you need to record both wink timing and far end test line results on a group of circuits, use **PRINTER** remote mode. The 930A will print out both the wink timing and the test results at the end of each call.

5-52 E-911 PSAP SIMULATOR (MENU OPTION 52)

The 930A interfaces to one or two T-1 test spans on the Digital Switch. If call completion and call retry are being tested, only one test span is required. If call transfer to a PSAP is being tested, two T1 test spans are required.

In ordinary operation, the Digital switch will route an incoming 911 call to a channel on the appropriate T1 span. It will seize the channel (go off hook using A and B bits), await the wink MF Sequence and look for return Supervision indicating the operator has answered. The switch will then provide a talk path between the incoming caller and answering operator.

STEP 1 (OPERATION)

Once the call completes, the operator has the option of transferring the call to a PSAP. The switch will recognize a hook flash from the operator (On-Hook supervision for approximately .5 seconds) and provide a dial tone to the operator without dropping the incoming call. The operator sends DTMF digits to transfer the call. The switch uses these digits to select an appropriate PSAP destination. Depending on the digits the operator sends, the switch may then seize a second line and await another wink start signal. The switch will then outpulse the appropriate Automatic Number Identification (ANI) code and provide a conference call connection between the incoming call, the original operator and the PSAP. If the original operator dials a different DTMF code, the switch will ring the appropriate telephone number and provide a conference call connection. The operator may give a hook flash to disconnect the PSAP without dropping the incoming call, and another hook flash to initiate a second transfer. If the PSAP disconnects from the conference call, the next hook flash from the operator draws dial tone and initiates another call transfer.

STEP 2 (OPERATION)

The role of the 930A is to simulate the operator console and the PSAP, and to confirm the correct operation of the switch. Using the E911 Software, the 930A will look for seizure on the incoming test span, provide a wink, display and analyze the "calling number" ANI digits. If automatic call retry is tested, the 930A will remain on hook and wait for the switch to try again. Otherwise, the operator should go off hook and provide a talk path between the telset jacks of the 930A front panel and the digital switch. The tester

can examine the ANI spill for correct digits, timing, amplitude and voice.

If call transfer is being tested, the 930A will:

1. Provide a hook flash
2. Wait for dialtone
3. Send any user selected DTMF digits
4. Look for a seizure on a second T1 span
5. Provide a wink start signal on this second span
6. Display and analyze the ANI spill sent by the Switch on this span
7. Go off hook
8. Provide a talk path

The overall procedure for E911 testing with the 930A is as follows:

1. Connect the 930A to the digital switch via one or two T1 Spans
2. Set the switch to route incoming 911 calls to the first T1 Span
3. Set the switch to route transferred PSAP calls to the second T1 span
4. Set the 930A T1 format to match the switch
5. Select the E911 Emulation option 52
6. Select the length of hook flash for call transfer if desired
7. Place test calls into the Switch

5-52.1 930A OPERATIONAL PROCEDURES:

Begin by connecting the T1 span to which incoming 911 calls will be routed to the 930A **PCM1 IN and PCM1 OUT Jacks.**

Connect the T1 span to which transferred PSAP calls will be routed to the 930A **PCM2 IN and PCM2 OUT Jacks.**

Turn on the 930A. Press the Trunk Type key and select PCM. Display is shown below:

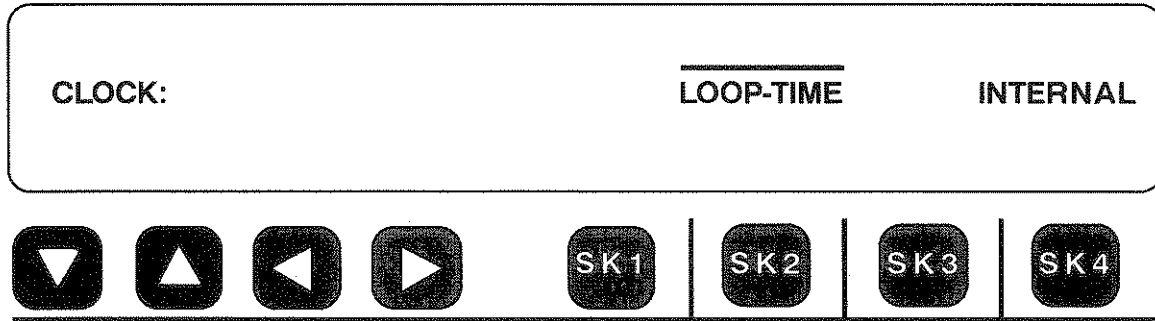

Go to **OPTION MENU 52** and press **ENT**.

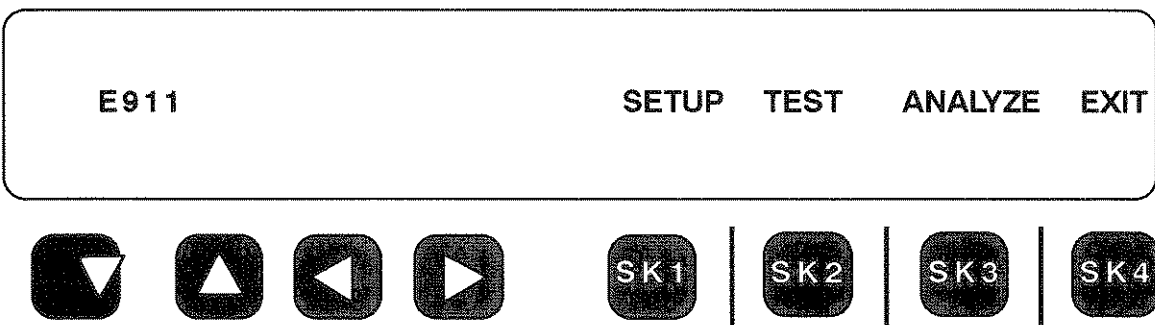

To adjust the length of the operator hook flash, select **SETUP** and you see the screen below:

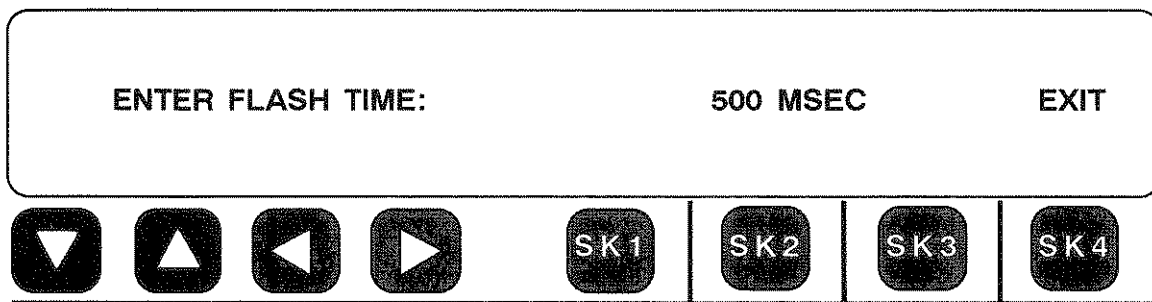

This is the default length for E911 hook flash. If you wish to use a shorter or longer flash, use the numeric keypad to enter the **length**. Select **EXIT** when you are finished. You will return to the main display below:

be able to verify a voice connection between the originating telset and the 930A. If you wish to analyze the frequencies, amplitude and timing of the ANI digits sent by your switch, select **EXIT** followed by the **ANALYZE** softkey followed by the Main menu. If you wish to transfer the call, select the 930A without disconnecting the originating telset.

The 930A display will change to:

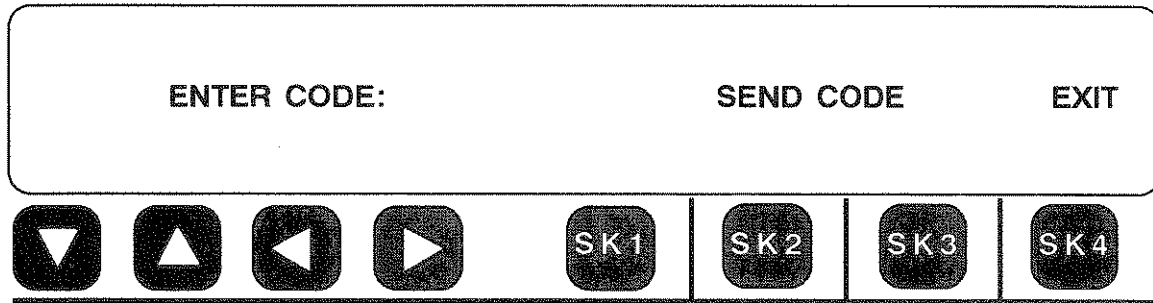

Use the numeric keypad to enter the DTMF digits you will use to transfer the call. When the digits display are the ones you wish to send, select **SEND CODE**.

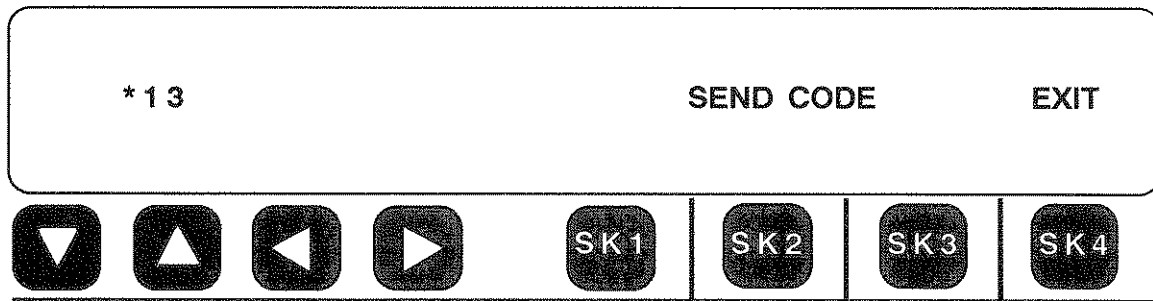

The 930A will send the displayed DTMF digits to the switch over **PCM1**. Your switch should transfer the call to the test span connected to the 930A **PCM2** jacks. The 930A display will change to:

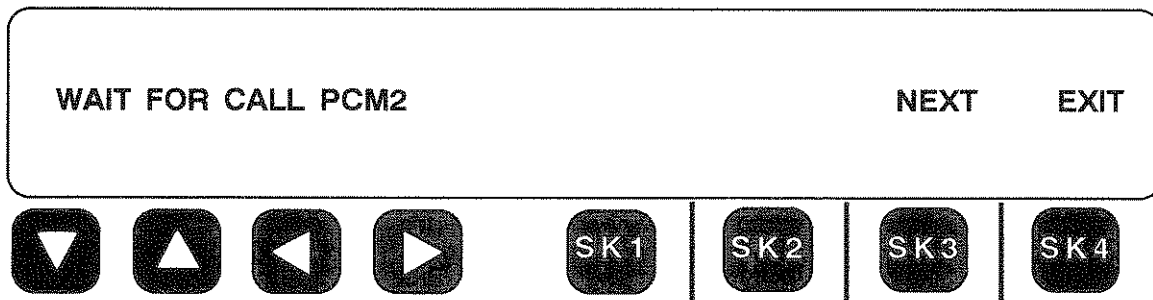

The 930A will respond to a seizure on any channel of the second T-1 span by providing a wink and capturing MF digits, then going off hook and providing a talk path between the 930A telset jacks and PCM2. The display will change to show:

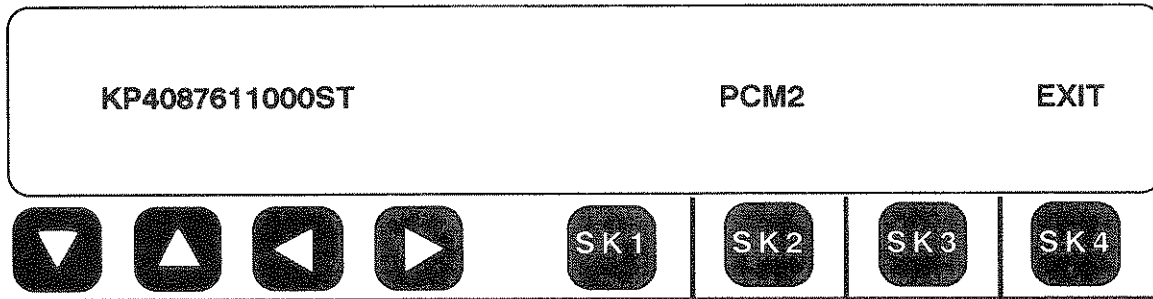

You should be able to verify a talk path between the telset jacks and the originating telset. By pressing the softkey under the word **PCM2** on the 930A display, you can toggle the 930A talk path between **PCM1** and **PCM2**. This allows you to confirm that your switch has provided a conference call between the originating telset, **PCM1 (911 operator)** and **PCM2 (PSAP)**. When **PCM1** is selected on the 930A, the display shows:

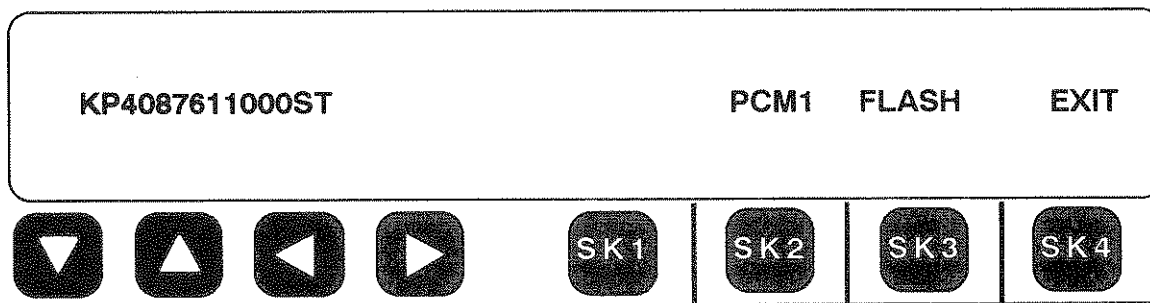

Selecting **FLASH** causes the 930A to send a hook flash over **PCM1**, disconnecting the **PSAP** call routed to **PCM2**. This should not disturb the connection between **PCM1** and the originating telset. Pressing Softkey 1 to toggle between **PCM1** and **PCM2** should verify that **PCM1** has a talk path to the originating telset and **PCM2** is disconnected.

Selecting flash a second time should cause your switch to setup for a second call transfer. Dialtone should be returned over **PCM1** without disconnecting the originating telset. The 930A will again display:

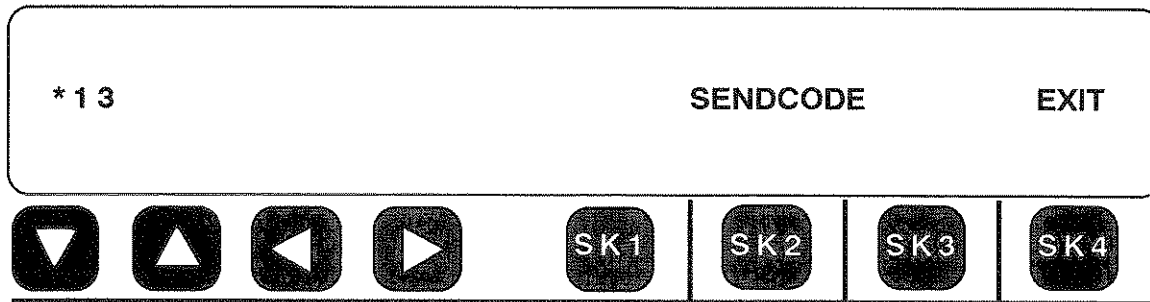

Press the **CLR** key on the 930A front panel to clear the old DTMF code. Use the numeric keypad to enter new digits. Select **SEND CODE** when you are ready. The switch should initiate a second call transfer. The 930A will again display:

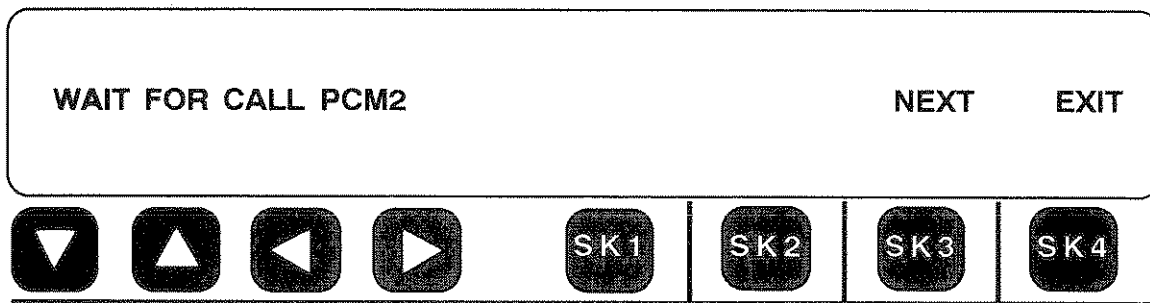

If the DTMF code sent is one that causes your switch to transfer the call to a **PSAP** routed to **PCM2**, the sequence previously described will repeat: The 930A will respond to a seizure on **PCM2** with a wink, capture the ANI spill and display it. The operator will be allowed to toggle between **PCM1** and **PCM2** to confirm a conference call by pressing the softkey under the PCM number that appears on the screen. When on **PCM1**, you will be able to send a flash to disconnect the **PSAP** without losing the originating caller, and a second flash to transfer the call.

If the DTMF code sent causes the switch to transfer the call to one of the terminating telsets, there will be no seizure to the 930A on **PCM2**. Instead, the switch will ring one of the terminating telsets. Answer the ringing telset. The 930A will display:

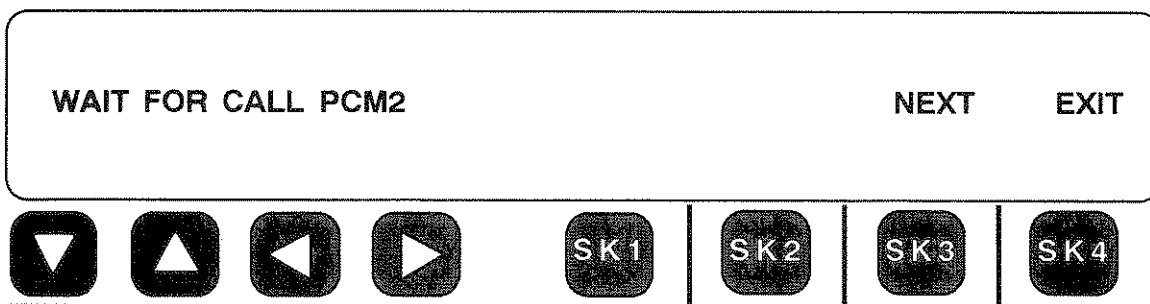

Select **NEXT**. The 930A display will change to show:

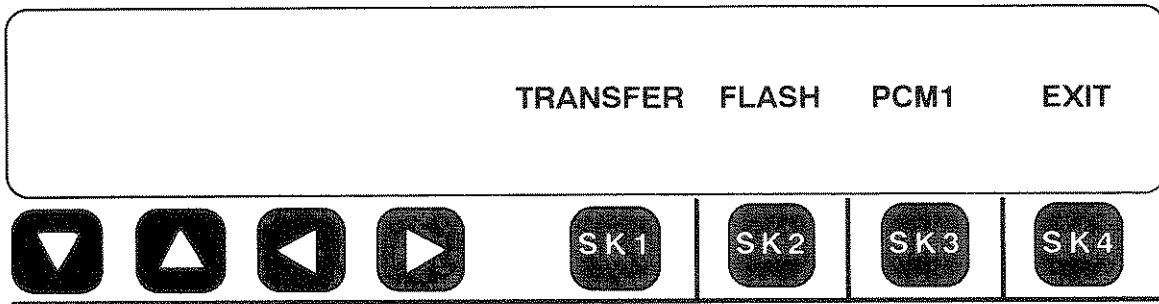

Selecting **FLASH** on the 930A causes a hook flash to be sent to the switch. If the terminating telset is still off hook when the flash comes, the switch should disconnect it. A second hook flash should cause the switch to provide dialtone to the 930A and set up for another call transfer. If the terminating telset is on-hook when the first flash comes (already disconnected), the switch should provide dialtone to the 930A and immediately setup for another call transfer.

Select the **FLASH** softkey twice, or hang up the terminating telset, select **FLASH** once and press the **TRANSFER KEY** to continue to the next function. The 930A display will again show:

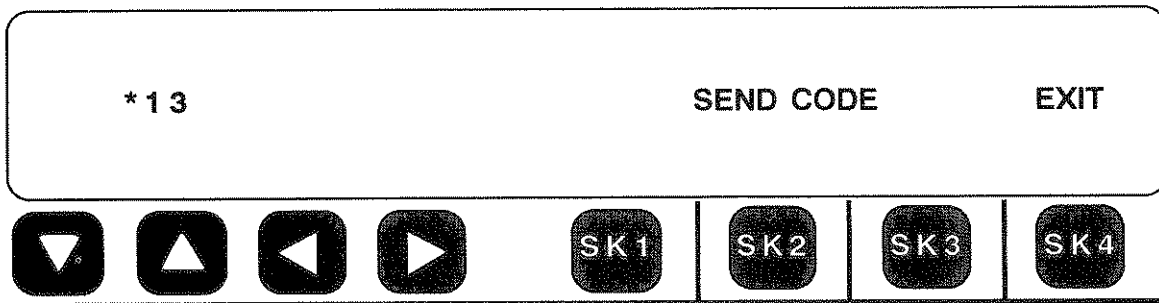

The 930A is ready to transfer the call again. When you are ready to receive another test call, simply put the 930A on-hook using the hook switch on the 930A front panel. The display will again show:

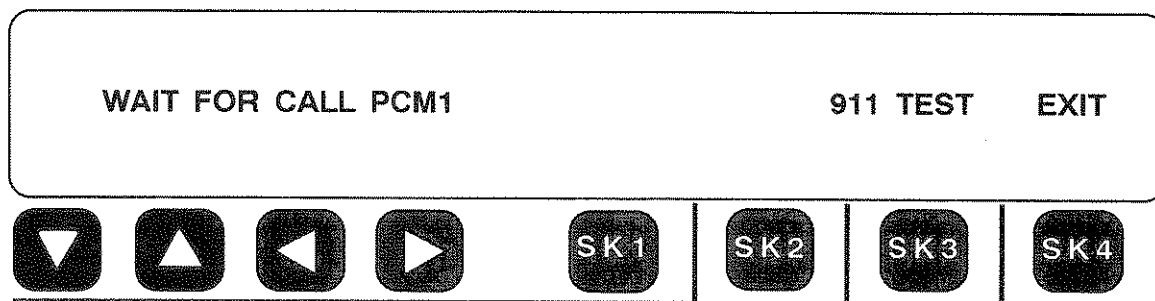

Using the techniques described above, you may receive calls from either originating telset, transfer calls to either terminating telset or to the **PCM2** T1 span at the 930A, test standard and anonymous ANI spills and test call transfer to an 800 number.

By switching the bantam jacks between **PCM1** and **PCM2** on the 930A, you may route **E911** calls to your second test span and route transferred to the first test span (or to the terminating telsets). The procedure is the same.

To test your switch's ability to automatically retry unanswered E911 calls, place the call from your originating telset to the 930A, but do not put the 930A hookswitch in the off-hook position when you see the incoming ANI digits. After a timeout, the switch should drop the call, seize another channel on the PCM T1 span and try again. The 930A will detect the call dropping off and respond to a new seizure on any channel on **PCM1** by providing a wink and capturing the ANI spill.

5-56 DS-0 BIT ERROR RATE TESTING (BERT) WITH THE 930A (MENU OPTION 56)

If you have purchased Option 930A-22 for your 930A, you will find that Menu Option 56: **DS-0 BIT ERROR RATE (BER)** has been enabled. This feature enables you to test at the 56 Kbps or 64 Kbps rates. It does not test individual sub-rates such as 9.6 Kbps. However, once you have tested the DS-0 path and found nothing wrong, the problem must be from the Office Channel Unit (OCU) or Channel Service Unit (CSU) back toward the terminal equipment. This means swapping out the suspected OCU plug-in or CSU/DSU or hauling out the Protocol Analyzer anyway so why add steps to the test. The purpose of the DS-0 BERT in the 930A is to help you quickly sectionalize the problem. If you can point the finger at the devices connected to the DS-0 path and away from the transmission facility itself then this has been accomplished.

The DS-0 BERT is used with the 930A in PCM TRUNK TYPE. The Terminate mode or Drop and Insert mode can be selected. The following sections outline test cord connections, BER testing in various situations, how to send Loop Up and Down codes and how to change the test parameters if you have to.

The 930A itself can throw a loopback on a particular channel. This loopback can be for analog signals such as tones or it can be for digital patterns. This is discussed later on in this section.

5-56.1 HOW TO SET UP THE 930A FOR DS-0 BER TESTING

When you want to do a **DS-0 BER** test using the 930A, you first have to set the Trunk Type up to **PCM** and then select the correct mode (**Terminate** or **D&I**). A brief reminder of the test cord connections and trunk settings is diagramed below.

To **Terminate** a T-1 span and run a DS-0 BER Test on a channel:

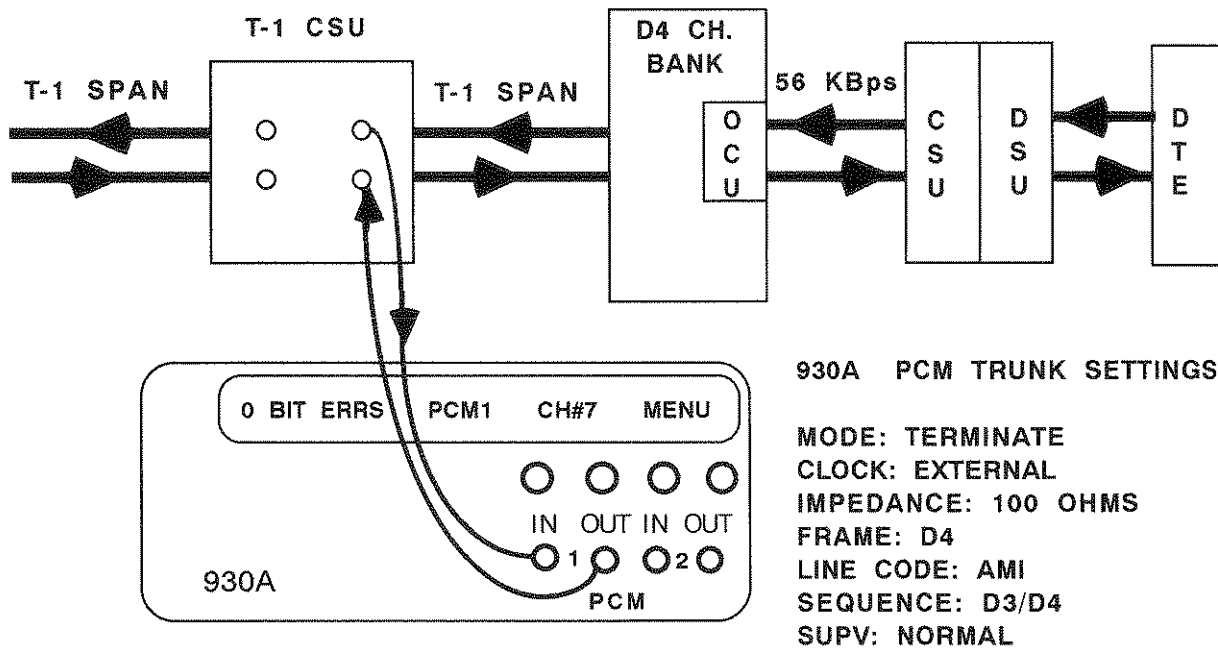

**DS0 BERT TEST CONFIGURATION
 FIGURE 5-20**

In the above example the 930A has been connected at the Equipment side of the customer's T-1 Channel Service Unit (CSU). The testing is toward the D4 Channel Bank. There is an Office Channel Unit (OCU) dataport plugged into time slot 7 or channel 7 on the bank. The 56 KBps output from the OCU is fed to a combination Channel Service Unit/Data Service Unit (DSU) which interfaces to the Data Terminal Equipment (DTE). To test the path, you would successively loop back the devices on the path and run a BER test until errors were found. Start by looping the OCU, then the 56 KBps CSU, then the DSU.

A diagram of the 930A connected for Drop and Insert testing is provided on the following page.

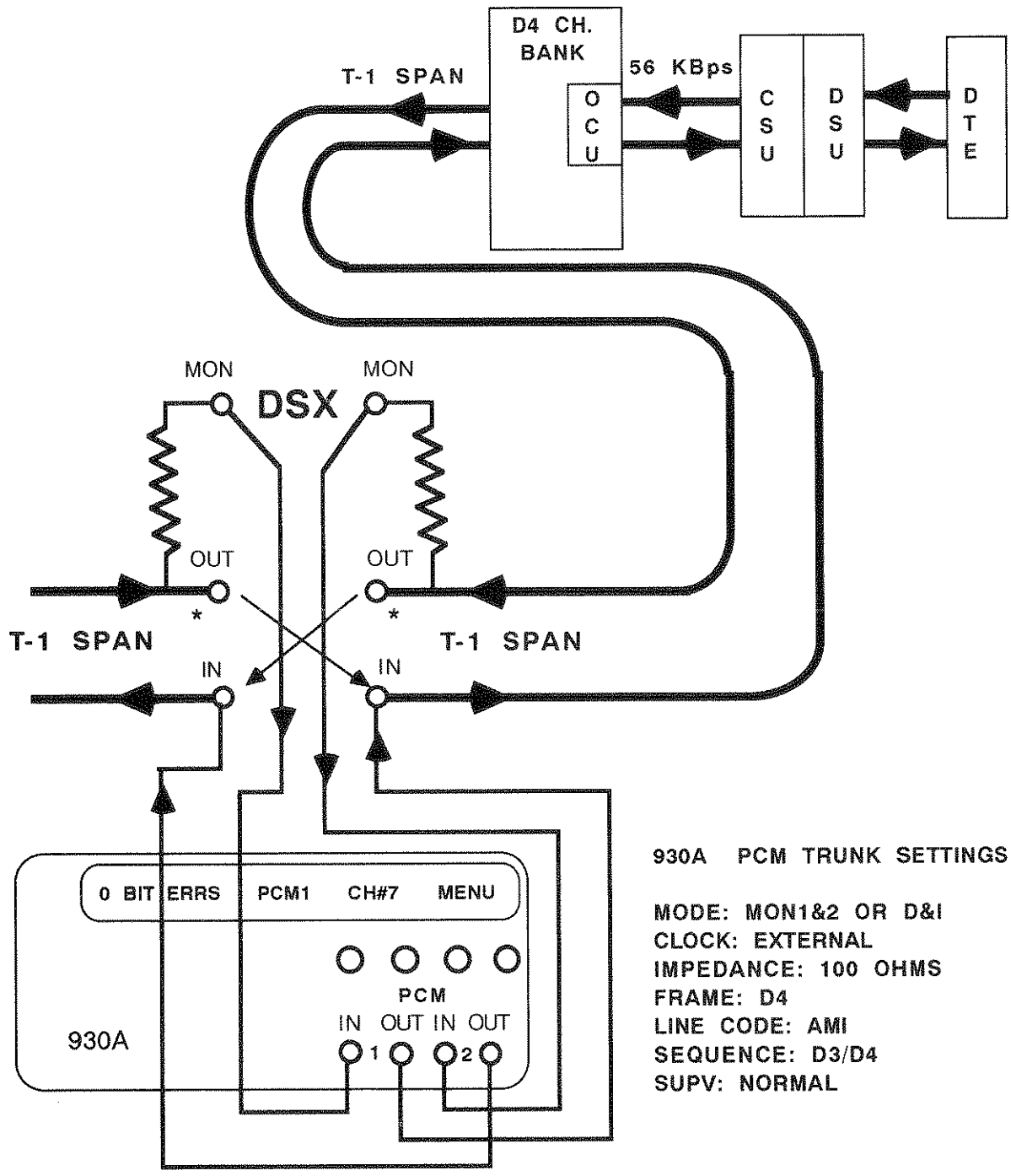

930A PCM TRUNK SETTINGS:
 MODE: MON1&2 OR D&I
 CLOCK: EXTERNAL
 IMPEDANCE: 100 OHMS
 FRAME: D4
 LINE CODE: AMI
 SEQUENCE: D3/D4
 SUPV: NORMAL

**DSO BERT DROP AND INSERT
 FIGURE 5-21**

Once you have set the 930A correctly and connected the test cords, you can test in either direction on any channel you wish without disturbing the other 23 channels on the T-1 span.

After connecting the 930A to the span under test, the rest of the procedure consists of getting to the DS-0 BERT menu and running the tests. The following steps outline the set-up and test procedures.

Press the OPTION MENU  Option Menu function key.

Use the UP/DOWN   arrow keys to

get to **Menu Option 56: DS-0 BIT ERROR RATE.**

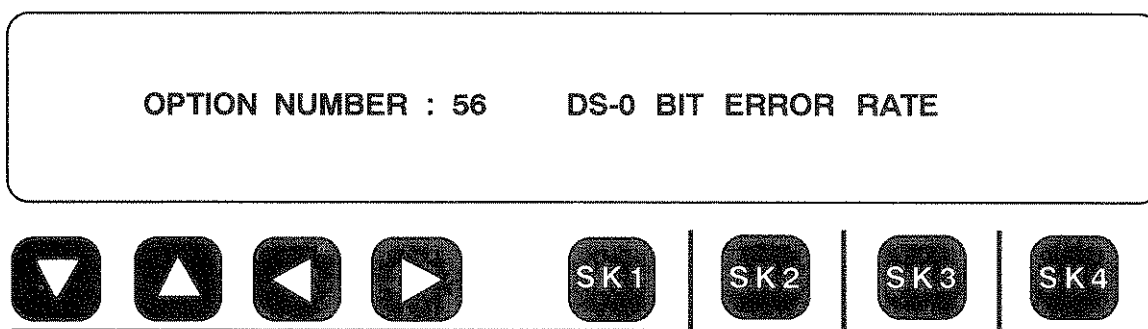

Enter Menu Option 56 by pressing any of the softkeys under the display and the main selection menu will be displayed. You can also enter the number **56** from the keypad and then press the **ENT** (Enter) key.

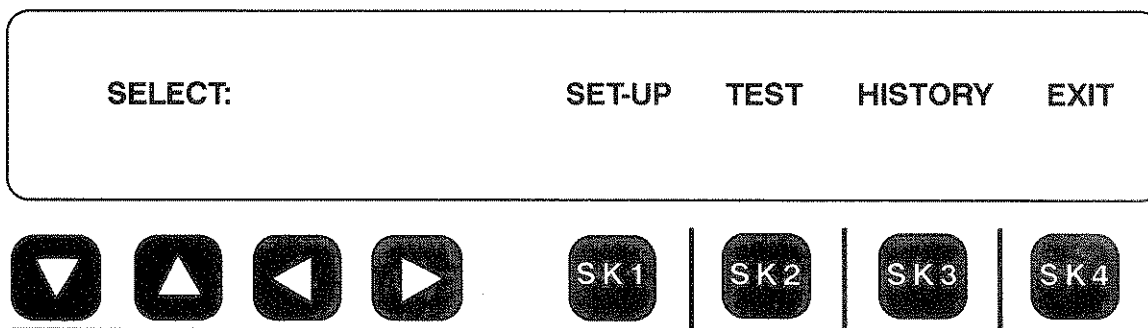

You must determine if you require a NX56 (56K), NX64 (64K) Clear Channel or DDS 56(56K) and what the test pattern is i.e **2047** and whether the test should be continuous or not. Press **SETUP**. The following screen is displayed:

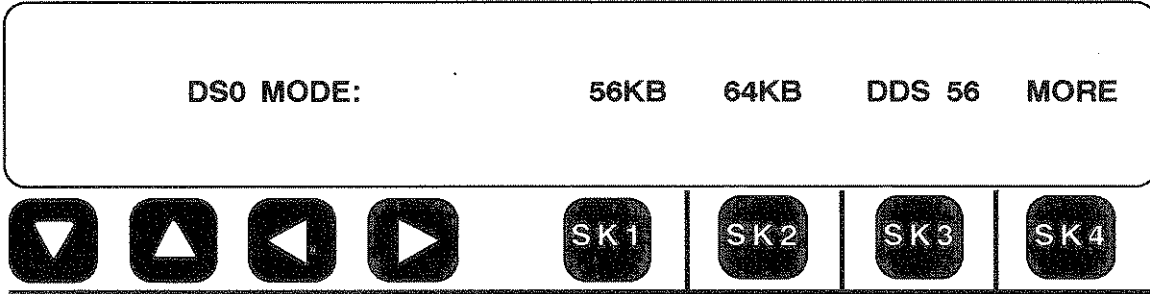

Select the **56KB** button or press **MORE**. The following screen is displayed:

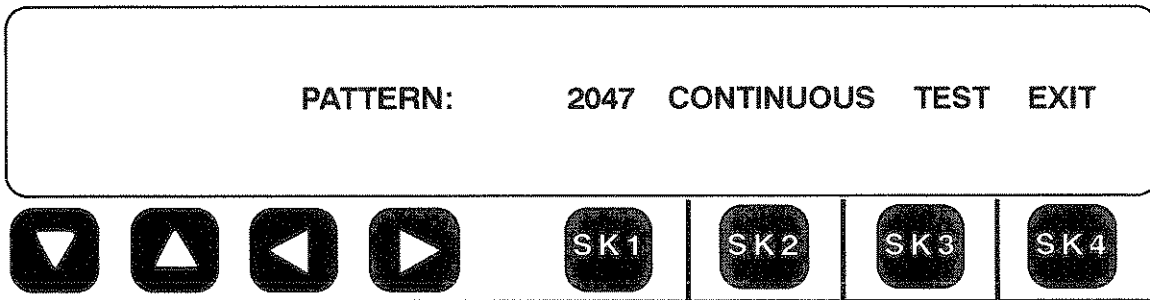

The **DEFAULT** pattern here is 2047 pseudo-random sequence. The test will run continuously. You can choose other patterns by pressing softkey 1 to scroll through the various choices. The following patterns are available:

| | |
|------------|---------------------------------|
| $2^{11}-1$ | (2047 bits) |
| 2^9-1 | (511 bits) |
| 1:7 | (a 1 and 7 zeros) |
| USER | (user inputs any 8 bit pattern) |

To input a USER pattern, select **USER** by pressing Softkey 1 until **USER** appears and then press Softkey 4 under **EXIT**. You can then enter any 8 bit pattern of 1's and 0's you wish. The pattern will be continuously repeated when you begin testing. Press Softkey 4 under **MORE** to return to the main menu Press **2047**. Pressing SK2 or SK3 will scroll through the various durations of test including 15 Minute, 1 hour or 24 hours. Leave **CONTINUOUS** on screen by not pressing. Select **EXIT**. The following screen is displayed:

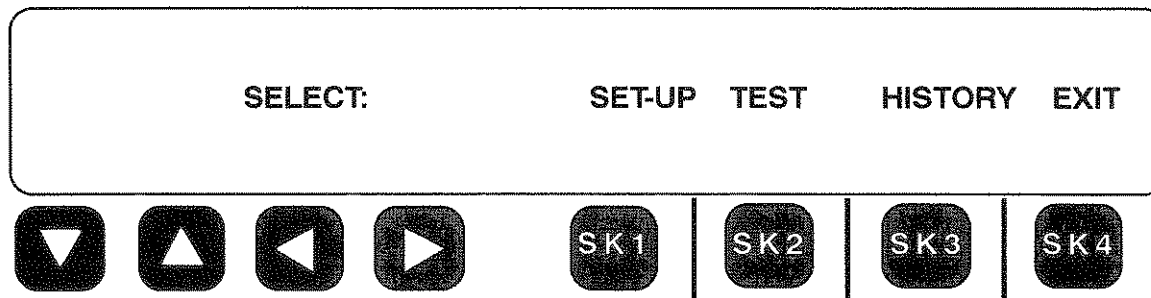

Press **TEST**. This will start the test. The following screen is displayed:

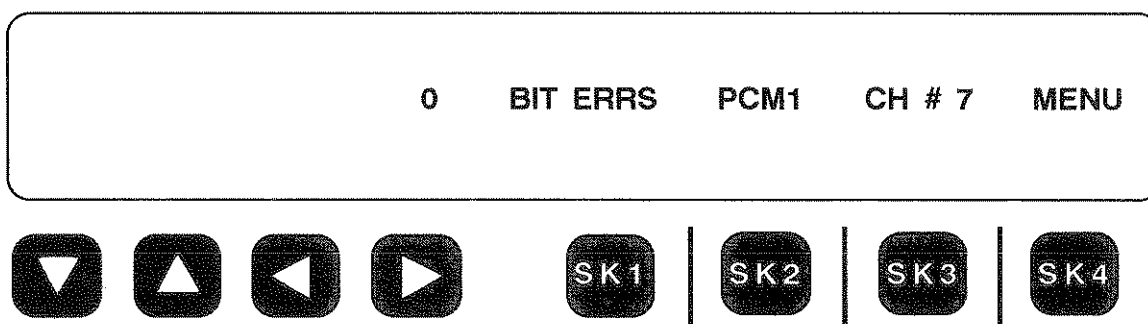

Ideally, you would achieve sync and there would be no bit errors on the main display. To test the integrity of the connection you might force some errors over the channel under test to see if they get counted properly. You press Softkey 4 under **MENU** and the display would show:

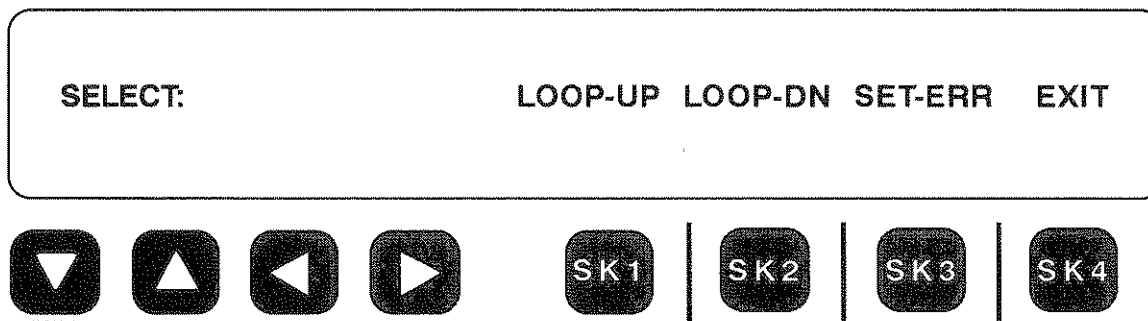

Press **SET-ER** to inject an error so that Proper pattern SYNC can be verified. The following screen should be displayed:

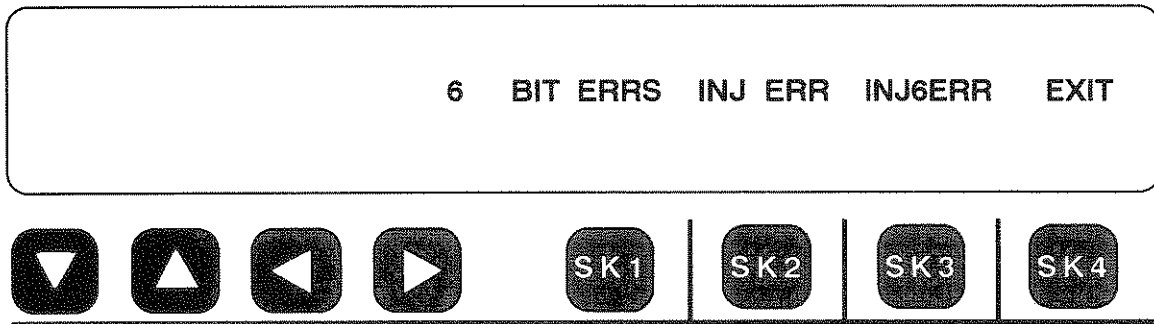

From this display you can count errors as well as inject them. PRESS SK2 **INJ ERR** to inject a single error to the other end. If you press Softkey 4, you exit back to the main display.

Pressing Softkey 3 under **INJ6ERR** allows you to inject 6 bit errors at a time.

5-56.2 DS0 BER TESTING REQUIREMENTS

If you set the 930A for **AMI** Line code and "**Robbed Bit**" Signalling, you can set the DS0 rate to 56KBPS only. If you select "**CCIS**" signalling for the **DS1**, you can select the **DS0** rate to 64K Clear Channel.

Warning: You cannot pass 64K DS0 BERT tests without error unless you adhere to the Clear Channel rule above.

5-56.3 POINT TO POINT DS0 BERT TESTING

If you are testing point to point over a T-1 span and simply wanted to measure the bit error rate on one of the channels, you can use a 930A or compatible BERT test set at each end of the span.

You can also force one of the 930As to throw a **loopback** on the DS-0 channel under test. You can do this by first selecting **Menu Option 57: DS-0 LOOPBACK** and then selecting Digital Loopback. The channel you have selected under the PCM Trunk Type will then be looped back. The other 23 channels will remain as they were. **DO NOT USE** the VF Loopback except for analog tones. VF Loopback will not work with digital BER patterns. You can also access your selection from **Menu Option 4:**

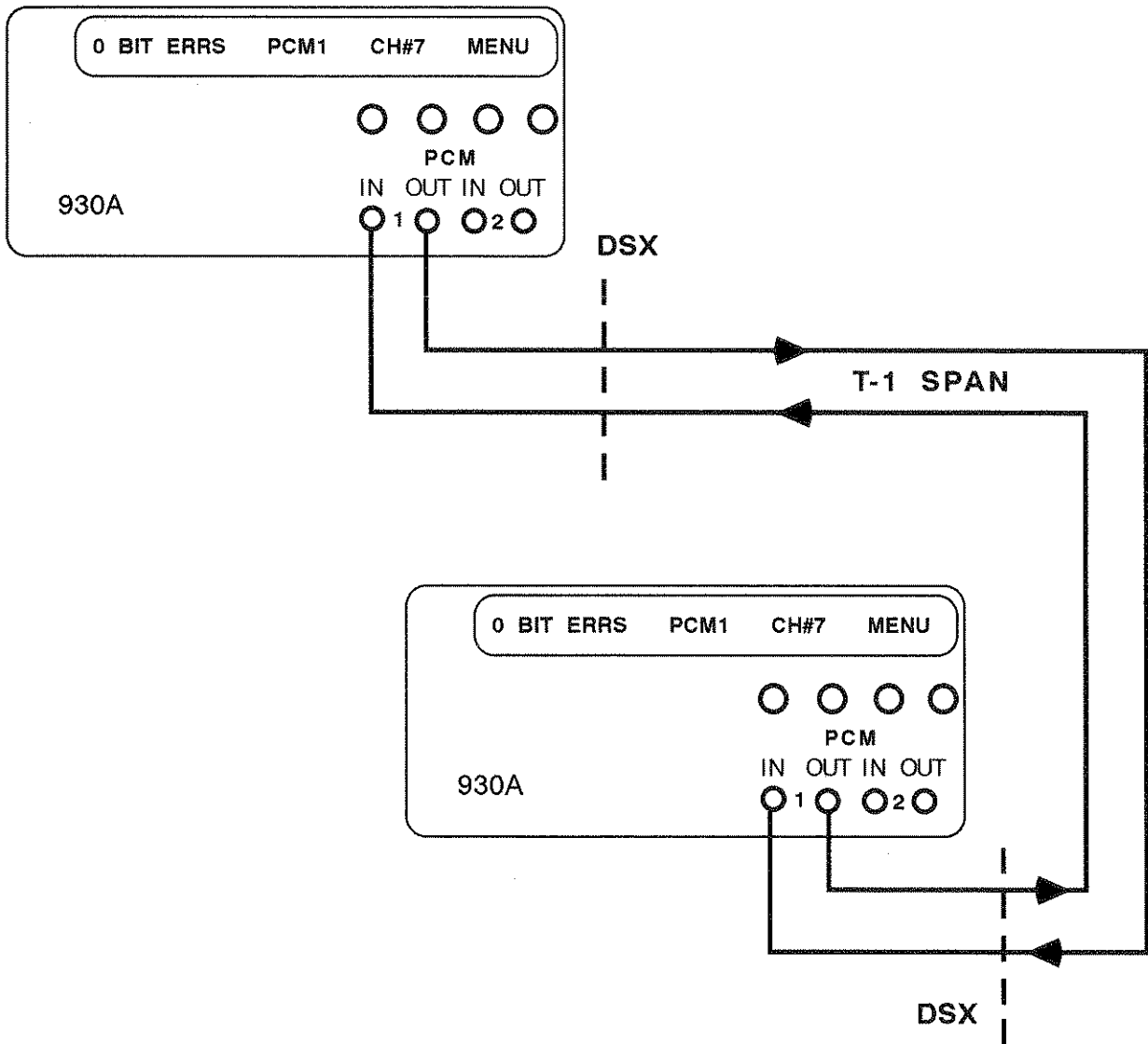

DS0 BERT WITH TWO 930A TEST SETS
 FIGURE 5-22

5-56.4 LOOPBACK BER TESTING ON 56 KBps DDS TRUNKS

Bit Error Testing on Dataphone Digital Service[®] (DDS) is in many ways easier than point-to-point testing. This is because DDS equipment responds to digital loop-up and loop-down commands. That means you can test from one 930A into the DS-0 channel and there is no need to have another 930A at the far end.

Again, the first step is to set up the 930A to either terminate the T-1 span or for Drop and Insert. You can connect the test cords at the DSX or at a T-1 CSU. The diagram below will serve as a discussion point.

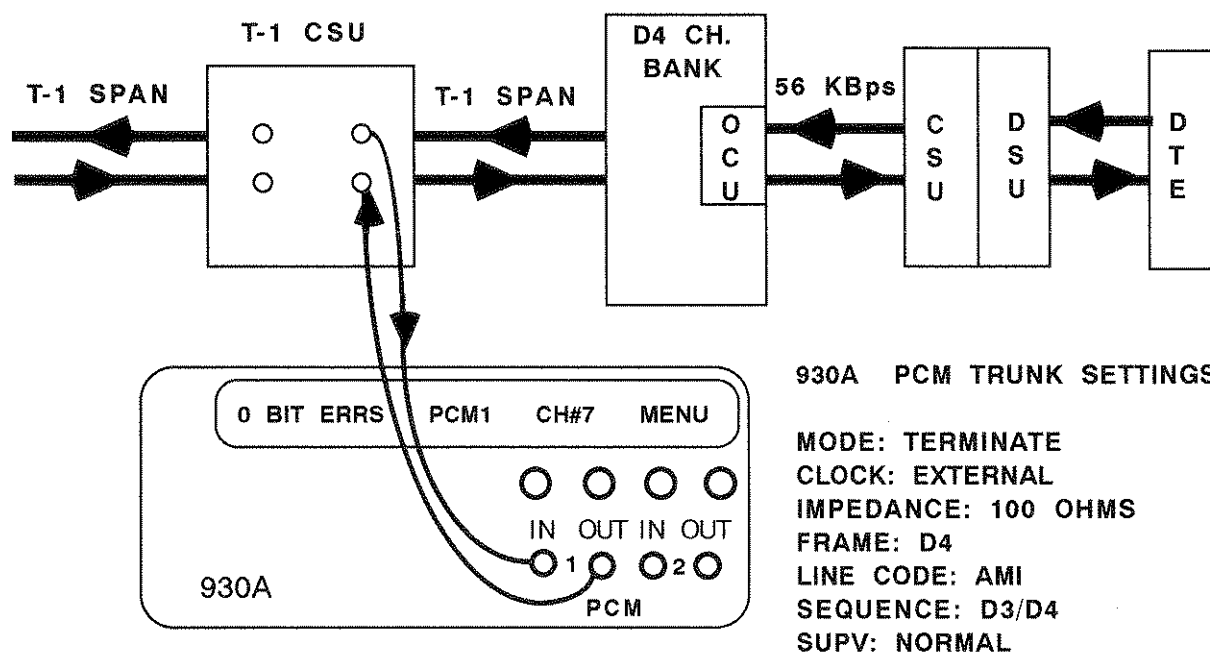

LOOPBACK BER SETUP
FIGURE 5-23

In this case the equipment side of the T-1 CSU is connected to a D4 channel bank which in turn feeds a 56 KBps OCU on Channel 7 to a CSU/DSU. Testing would normally begin by looping the DSU back and running a BER test for 15 minutes or so with a number of different stress patterns. If errors are not encountered the trunk is probably good. If errors are encountered then you must successively loop back the equipment on the trunk to determine where the problem is. If you loop back the 56 KBps CSU next, repeat the test patterns and find no errors, then the DSU is bad. If the errors still persist, then loop back the OCU. If you get errors then the OCU is bad. If you do not get errors, then it is a safe bet that the CSU is bad or the line interface connection to it is bad.

The loop-back patterns which the 930A can send are:

| | |
|-------------|---------------------------------|
| OCU-ALB | OCU Alternating Loopback |
| CSU-ALB | CSU Alternating Loopback |
| DSU-ALB | DSU Alternating Loopback |
| DP DROP-LLB | Dataport Drop-Latching Loopback |
| OCU-LLB | OCU Latching Loopback |
| CSU-LLB | CSU Latching Loopback |

Note: CSU Loopback cannot be performed if there are 56KB repeaters connected in the line.

Select the correct pattern for your application by pressing Softkey 1 or using the UP/DOWN arrow keys. When the correct pattern is displayed, press Softkey 3 under **SEND** and the pattern will be transmitted. The 930A will respond with a screen:

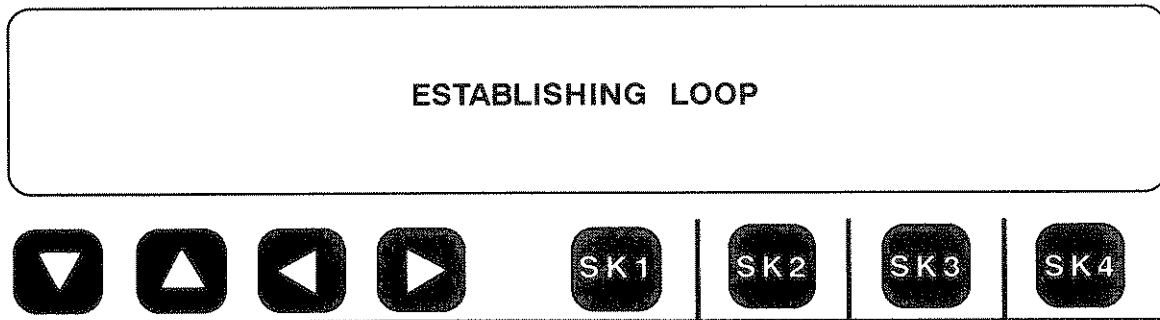

When the loopback is successful, the 930A display will show the main BER display screen.

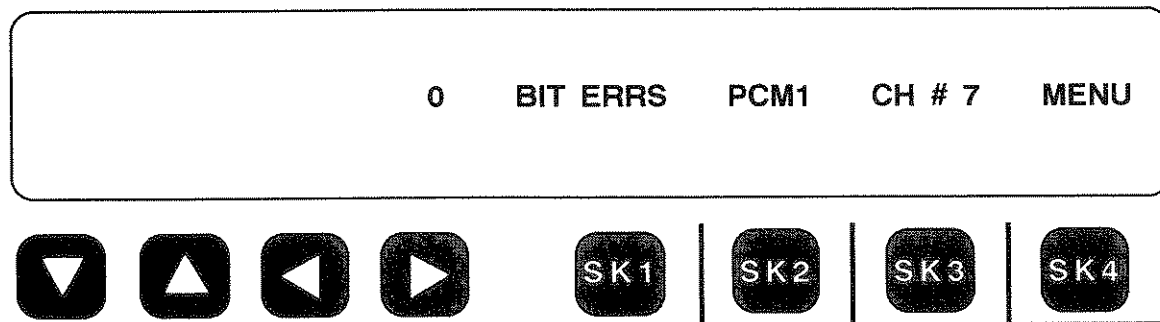

5-57 DS0 LOOPBACK (MENU OPTION 57)

The 930A can loop back the selected PCM channel in TERMINATE or Drop and Insert modes. This is similar to a hard loopback in operation because no codes are involved. You simply select **Menu Option 57: DS-0 LOOPBACK**.

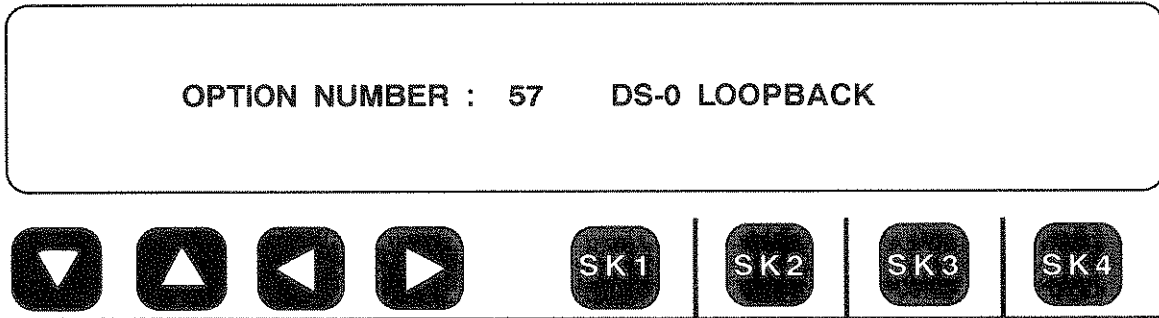

Pressing any softkey will bring up the loopback selection display:

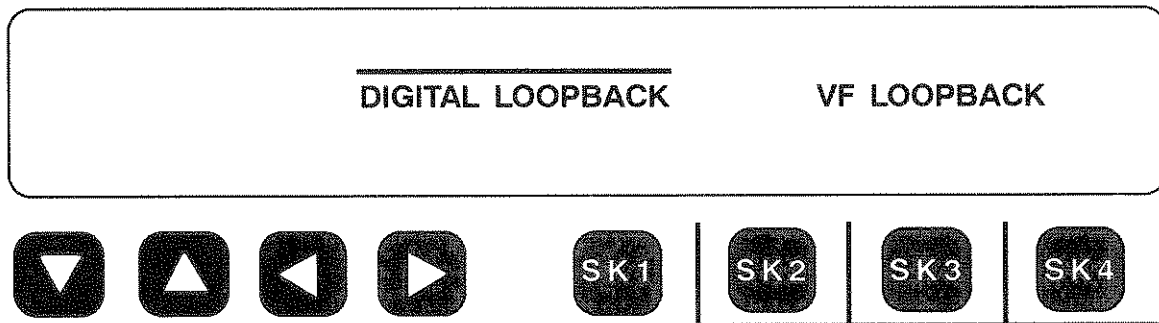

The default is **DIGITAL LOOPBACK**. This is the type you must choose if digital patterns are going to be looped back. That is, pseudo-random patterns such as the 511 or 2047 bit long patterns. If tones (e.g., 1004 Hz) are being sent toward you then you want to choose the **VF LOOPBACK**. Select **DIGITAL LOOPBACK** by pressing Softkey 1 and the display will become:

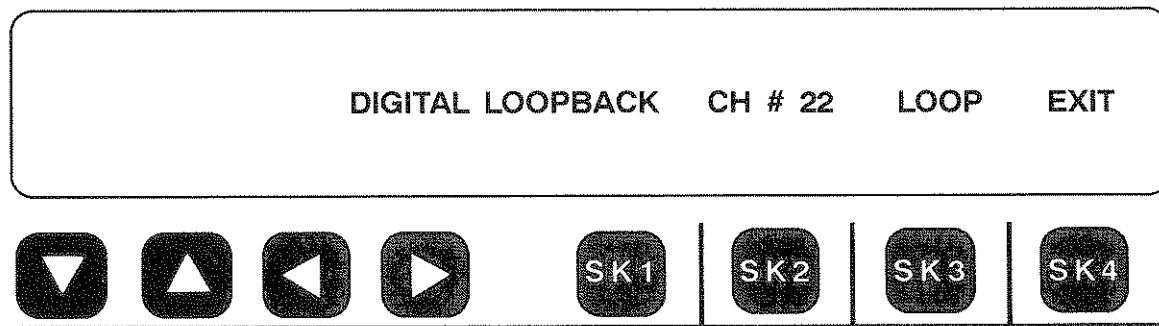

To initiate a loopback press Softkey 3 under **LOOP** and a cursor will appear over **LOOP** indicating that the selected channel has been looped back. In this example, Channel 22 has been looped back since it was the selected channel in trunk type. To loop back a different channel you must return to the PCM Trunk Type menu and change the channel there.

If you select **VF LOOPBACK** instead, the display is somewhat different:

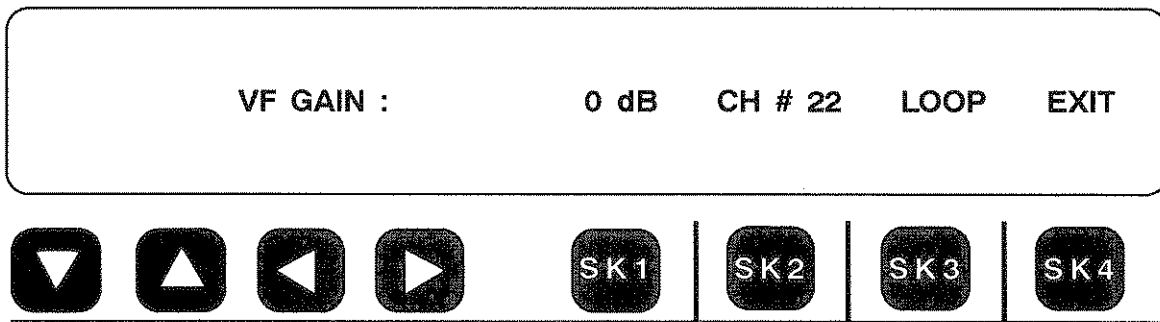

Here, you have the opportunity to insert gain or attenuation. The default is 0 dB but you can enter any number between +2 dB and -16 dB by pressing Softkey 1 and then using the keypad to enter the desired value. The VF Loopback also retains the companding algorithm which is suspended during a digital loopback.



To initiate a VF Loopback, press Softkey 3 under **LOOP** just as you would for a digital loopback.

Pressing Softkey 4 under **EXIT** will take down the loop and return the 930A to its normal state. Note that only the selected channel is looped. The other 23 channels pass through unimpaired.

**5-65 SETTING THE 930A TO WORK ON GROUND START COIN
PHONE TRUNKS (MENU OPTION 65)**

If you have occasion to use the 930A on Coin Phone trunks you will sooner or later encounter Ground Start trunks. While the 930A does provide ordinary Ground Start supervision under the TRUNK TYPE menu this is not enough when dealing with coin phone circuits. Menu Option 65: GND-ST COIN PHONE was added to the 930A to take care of this special case of Ground Start. You must first set the 930A TRUNK TYPE to the appropriate Ground Start trunk settings. Then do the following:

Press the OPTION MENU  Option Menu function key.

Use the UP/DOWN   arrow keys to
select Menu Option 65: GND-ST COIN PHONE.

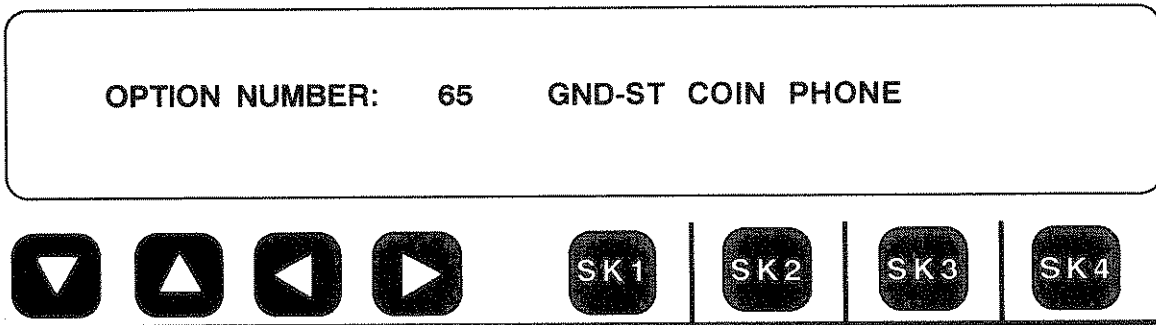

Press any softkey under the display to get to the main menu:

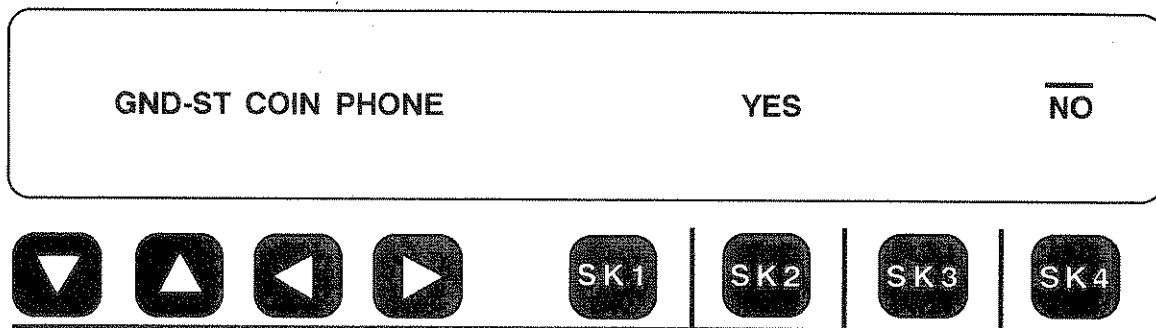

Press Softkey 2 under YES to place the 930A in the coin phone mode. The 930A functions and menu options continue to operate as usual.

5-87 TPT BURST LENGTH (MENU OPTION 87)

TPT burst length allows the length of the TPT tone it sends when acting as a Type 105 responder. This affects Option 25: **FAR END RESPONDER**. It also affects Option 4: **DIGIT RECEIVER**. The length is adjustable up to 25.5 seconds. This feature is used so that the 930A can be compatible with most or all Near End Responders.

Select Option 87 and press **ENTER**. The following screen is displayed:

| | | | | | | | |
|------------------|---|---|---|------|---------|------|------|
| TPT BURST LENGTH | | | | 2.5 | DEFAULT | EXIT | |
| ▼ | ▲ | ◀ | ▶ | SK 1 | SK 2 | SK 3 | SK 4 |

Select either the default of 1.5 seconds or any length up to 25.5 secs using the Keypad. Press **EXIT** when completed.

5-88 POST TPT DELAY (MENU OPTION 88)

Post TPT delay allows specification of the amount of time the 930A pauses between detecting Test progress tone (TPT) from a 105 responder and sending command MF digits. This affects Option Menu 27: ROTL/RESPONDER. It also affects Option Menu 2 and Option Menu 50 if the call sequence specifies termination on a 105 line.

Press Option Menu 88 and press **ENTER**. The following screen is displayed:

| | | | | | | | |
|-----------------|---|-----|---------|------|-----|-----|-----|
| POST TPT DELAY: | | 2.5 | DEFAULT | EXIT | | | |
| ▼ | ▲ | ◀ | ▶ | SK1 | SK2 | SK3 | SK4 |

Either press the default of 1.5 Seconds or determine the proper value and enter using the Keypad. Press **EXIT** when completed.

5-89 PRINTER HAND SHAKE (MENU OPTION 89)

Menu Option 89: PRINTER HANDSHAKE, allows you to select a form of flow control when the 930A sends data to the printer. This allows the printer to tell the 930A to stop sending when the printer's buffer is full or the printer is off-line. The factory default setting for the 930A is no flow control (handshake **OFF**), as it is not usually necessary.

If your printer misses characters sent by the 930A, especially during long printouts such as digit analysis or T-1 BERT history, select a lower baud rate or use Menu Option 89 to select a form of flow control.

The 930A supports **DTR** and **XON/XOFF** protocols. Press the **OPTION MENU** function key and use the **UP/DOWN** arrow keys to get to **Menu Option 89: PRINTER HANDSHAKE**. Press any softkey under the display to enter the menu. You will see a display like the one shown:

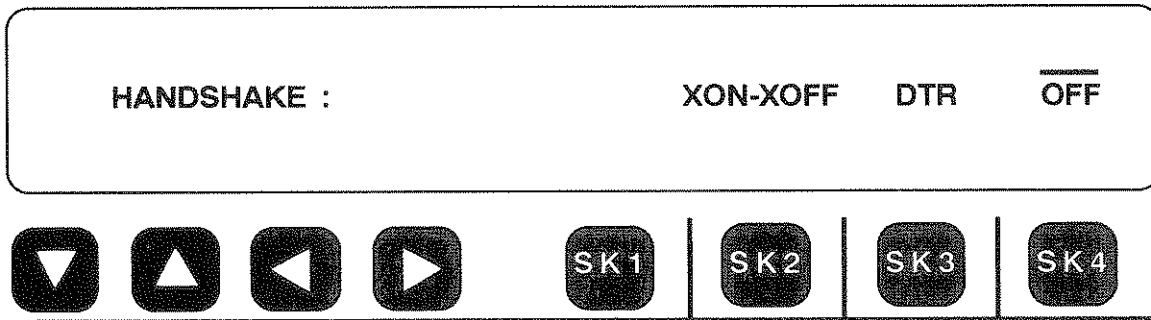

The factory default is **OFF** (no handshake). This allows the 930A to send to any serial device, even if only pins 2, 3, and 7 are connected on the serial cable. If this choice is not highlighted already, you may select it by pressing Softkey 4. Cold-booting the 930A will also restore this setting.

When **DTR** handshaking is selected, the 930A will send characters to the printer only when it sees positive voltage on **DTR** (pin 20). If your printer is off line, powered down, or has a full buffer, it will not provide this voltage and the 930A will "hang" when attempting to print. This allows the printer to "catch up" by printing the contents of its buffer while the 930A waits. You will probably need to enable **DTR** handshaking on your printer by using a DIP switch. The printers supplied by SAGE are shipped with **DTR** handshaking enabled. Press Softkey 3 (under **DTR**) to enable **DTR** handshaking for the 930A.

When **XON-XOFF** handshaking is enabled, the 930A will stop sending characters to the printer when it receives the **XOFF** character (**CNTRL-S**) from the printer. It will resume sending characters when it receives the **XON** character (**CNTRL-Q**). **XON-XOFF** protocol is useful when communicating over modems or other media which do not allow a separate hardware handshake, such as the **DTR** line. Some printers support **XON-XOFF** handshaking, as do most terminals and modems. Some modems can be set to convert **DTR** handshaking to **XON-XOFF**. To set the 930A to **XON-XOFF** handshaking, press Softkey 2.

When the 930A attempts to send characters and the handshake fails (there is no voltage on DTR or an XOFF character was received without an XON), it "hangs" until either the handshake succeeds or ten seconds have passed. If ten seconds pass without a successful handshake, the 930A turns the handshake OFF and proceeds normally. If a handshake fails because a printer is turned off or left off line when the 930A needs to print, you will need to re-enable the handshake by using Menu Option 89 again. As long as the handshake is successful, the handshake protocol is stored in battery backed RAM and will remain set.

5-90 DSP MEMORY TEST (MENU OPTION 90)

This menu is more useful to SAGE than to the customer. It is used during our manufacturing process. It checks the health of the memory on the DSP board in the 930A if you have purchased Option 930A-01. If you get strange test results in the digit receiver/analyzer even after a "Cold Boot," this would be another place to check.

You get to this menu like you do the others.

Press the OPTION MENU  Option Menu function key.

Use the UP/DOWN   arrow keys to

select Menu Option 90: DSP MEMORY TEST

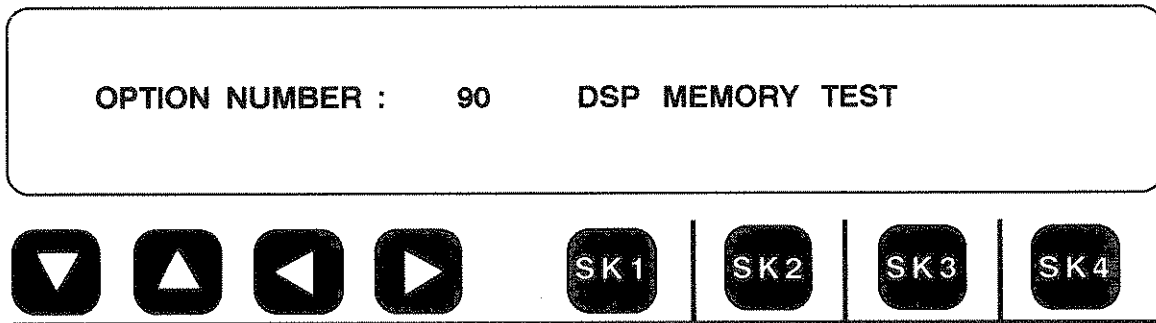

When you enter this menu you will see the following display, if all is well:

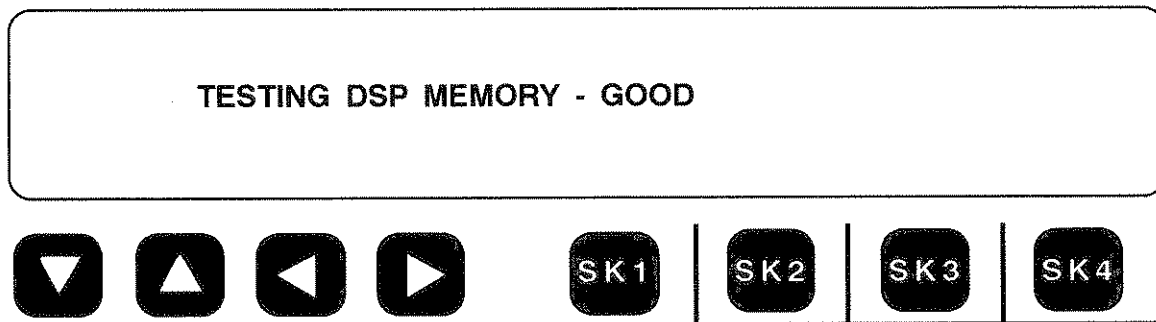



If you do not get this display, then you should call SAGE customer service at (408)761-1000. Again, **this menu only applies if you have Option 930A-01.**

5-91 WHERE TO FIND SOFTWARE VERSION (MENU OPTION 91)

You can turn the 930A off and then on again to determine the software level you have in the unit. But this is usually inconvenient so you can now go to Menu Option 91: **SOFTWARE VERSION** by doing the following:

Press the OPTION MENU  Option Menu function key.

Use the UP/DOWN   arrow keys to select Menu Option 91: **SOFTWARE VERSION**.

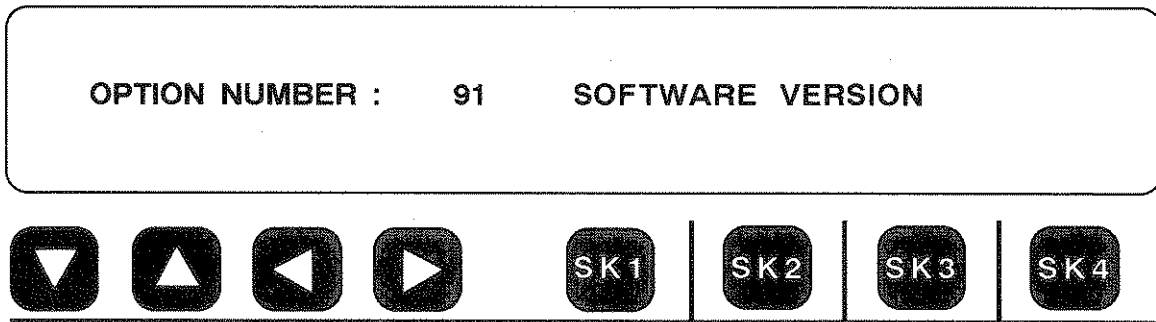

When you press any softkey under the display, you will see the version of software you have in your 930A.

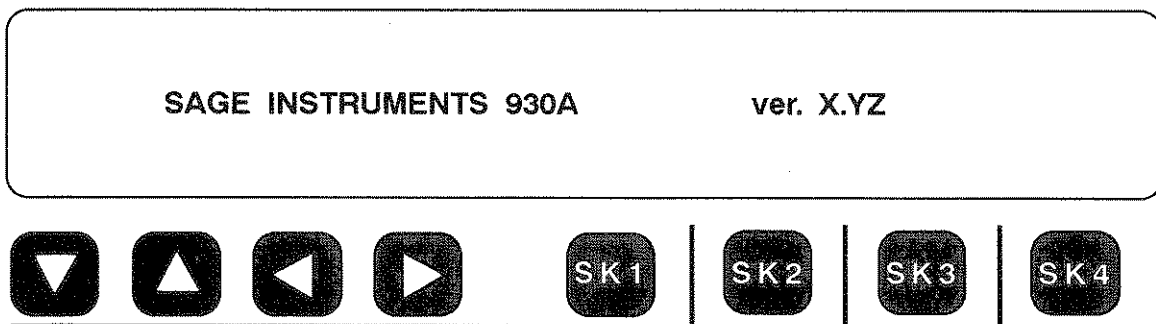

The operating system software in the 930A is updated from time to time. Upgrades to the current software version are free to the original owners for life. You may call SAGE Customer Service from time to time to see if you need to upgrade from your existing system. Usually this is not necessary unless we have added something to the list of standard features that your software does not have.

5-92 HOW TO DO A SOFTWARE COLD-BOOT (MENU OPTION 92)

Rather than doing a full Hardware Cold-Boot such as you would do when you change software in the 930A, you can do a Software Cold-Boot which is useful in restoring the 930A to its factory default settings. Someone else may use your 930A from time to time and may set in parameters that will affect your readings. This is a convenient way of starting from scratch so to speak. **The Software Cold-Boot does not affect the Remote Control settings (Menu Option 3).**

Press the OPTION MENU  Option Menu function key.

Use the UP/DOWN   arrow keys to

select Menu Option 92: SOFTWARE COLD-BOOT.

OPTION NUMBER : 92 SOFTWARE COLD-BOOT



WARNING! Once you press any softkey and enter this menu you will Cold-Boot the 930A. All memories will be erased and the factory defaults will be restored. The 930A will return to the 2-wire LOOP START Trunk Type default.

If you do not want to do this, then go to some other Menu Option and do not enter the one above. **Never enter this menu when the 930A is connected to a circuit.**

5-93 THE TEST DISPLAY (MENU OPTION 93)

This Menu Option is mainly used during manufacturing to test the display and the LEDs by turning everything on.

To get out of this menu, if you have entered it, just press the **OPTION MENU** key and you will get outside again.

5-94 HOW TO FIND OUT WHAT OPTIONS ARE INSTALLED IN YOUR 930A (MENU OPTION 94)

Menu Option 94: **LIST OPTIONS** tells you what purchased options you have in your 930A. You get to it by the following steps.

Press the OPTION MENU  **Option Menu** function key.

Use the UP/DOWN   arrow keys to select Menu Option 94: LIST OPTIONS.

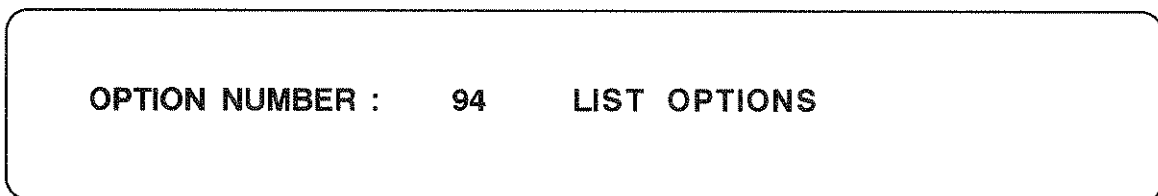

Once you get to this menu, press any of the softkeys below the display and the 930A will show you a screen such as the one on the following page.

Remember: The purchased option numbers do not match the Menu Option numbers. Refer to Table 5-1, on pages 5-3 and 5-4 in this section 322 to match the purchased option numbers with their locations under the Option Menu Function key.

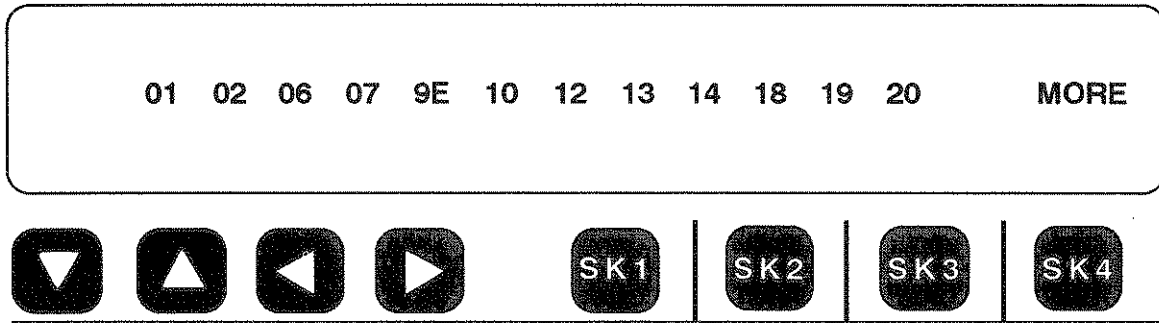

Pressing Softkey 4 (under **MORE**) would show the rest of the options such as:

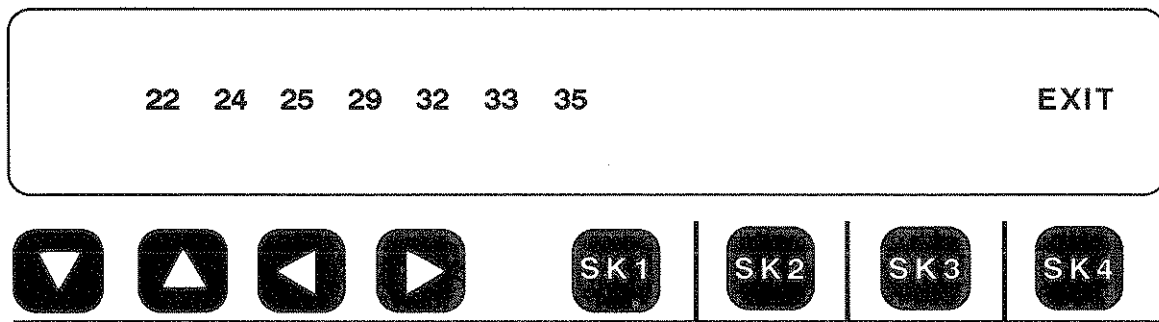

A 930A equipped with all these options could be said to be fully loaded. In fact, most 930As are not equipped with all of the available options by their owners. They are tailored to specific applications and once you have the basic 930A you can option it to your specific test requirements. The Switching groups usually order Options 930A-01, -07, -09E, -10C, -12 and -25. The Special Services and Transmission people usually order Options 930A-06, -07, -09E, -10C, -18, -19, and -20. Network Technical Support orders everything, including options we don't have. Facility Maintenance usually orders Options 930A-09E, -10C, and -22 as a minimum. However, as the distinction between Trunk and Facility testing blurs, we see the test sets being more heavily optioned as the testing requirements of the modern network change.

**5-95 HOW TO TEST DRY CIRCUITS WITH THE 930A
(MENU OPTION 95)**

The 930A normally expects to see supervision on the trunks it is testing. However, there are trunks that have no supervision on them. These are usually dedicated lines found in special services point-to-point applications. When you encounter these types of circuits you can place the 930A in a mode that removes supervision.

Press the OPTION MENU  Option Menu function key.

Use the UP/DOWN   arrow keys to select Menu Option 95: DRY CIRCUIT.

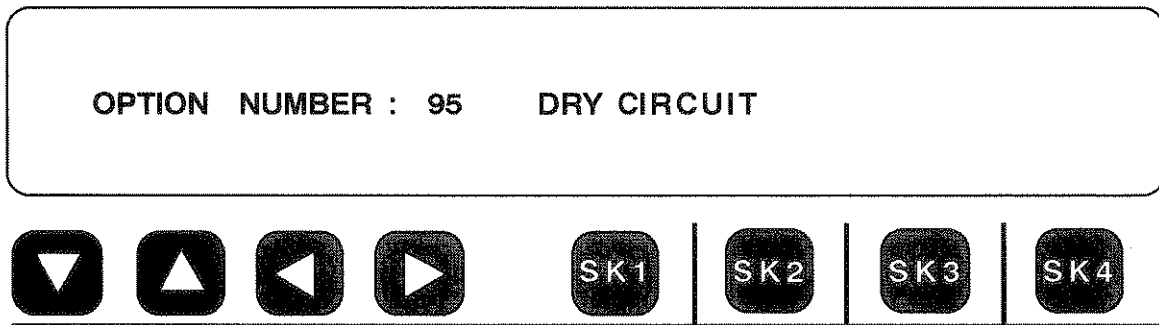

Press any softkey and the display will show:

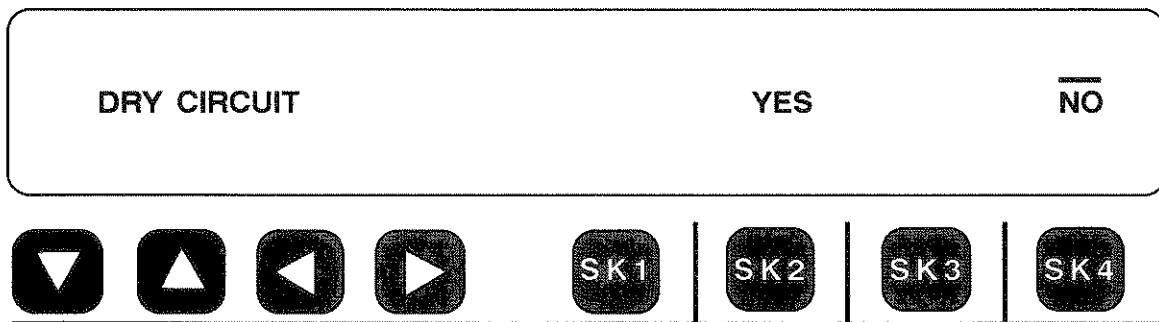

Press Softkey 2 under **YES** and the 930A will set the **TRUNK TYPE** to a Dry Circuit. The display will change to that shown on the following page.

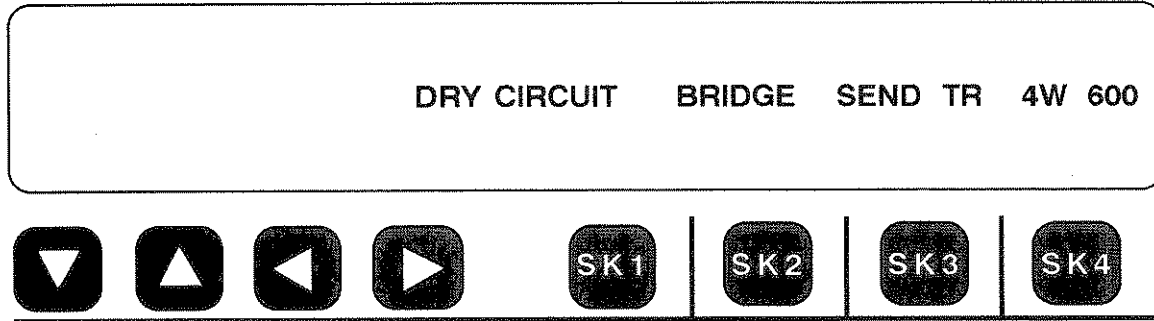

Press Softkey 4 (under **4W 600** above) to select 2-Wire or 4-Wire operation and impedances of 150 ohms, 600 ohms, 900 ohms or 1200 ohms.

Press Softkey 2 under **BRIDGE** to select **TERMINATE**, or vice versa.

Once you have set the correct impedance and operating condition, you just use the other functions (such as **SEND TONE** or **MEASURE TONE**) as you would with any other **TRUNK TYPE**.

Pressing Softkey 1 in the display above will cause the 930A to exit from this Trunk Type. You can re-enter this mode, or exit from it at any time, by returning to Menu Option 95 and pressing Softkey 4 under **NO**.

This page intentionally left blank.



SECTION VI

REMOTE CONTROL OPERATION

6-1 INTRODUCTION

The Model 930A, equipped with Option 930A-10C, can be remotely controlled, or may itself control a printer, through an RS-232C serial port located on the rear panel. The connector is a standard female 25 pin miniature "D" type connector. The mating male connector should be an Amphenol type 206771-1 or equivalent. Refer to Figure 6-1 for the location of the serial port on the rear panel.

The Model 930A has been designed to make operation under remote control as much like manual control as possible. There are no op-codes to memorize. Each front panel key function can be activated by a single ASCII character (a keystroke on the terminal or computer keyboard).

The Model 930A will work with most printers and terminals without modification to cables or reconfiguration of pins. The Model 930A serial interface is configured as Data Communication Equipment (**DCE**) and wants to "see" Data Terminal Equipment (**DTE**) connected to it. Since it is emulating a Modem (**DCE**), most terminals (**DTE**) and printers can be cabled directly to the Model 930A remote port.

If a computer is being used to control the Model 930A, and it has the capability of being either a **DTE** or a **DCE**, make sure that it is set to **DTE** emulation before connecting it to the Model 930A. If the equipment cannot be configured as **DTE**, then it will be necessary to swap pins 2 and 3 (Transmit and Receive Data). This can be accomplished by using a special cable known as a "NULL MODEM", or a breakout box. The pinouts for the Model 930A connector are shown in Figure 6-2.

Option 930A-10C also provides Real Time Clock.

RS-232C CONNECTOR LOCATION FIGURE 6-1

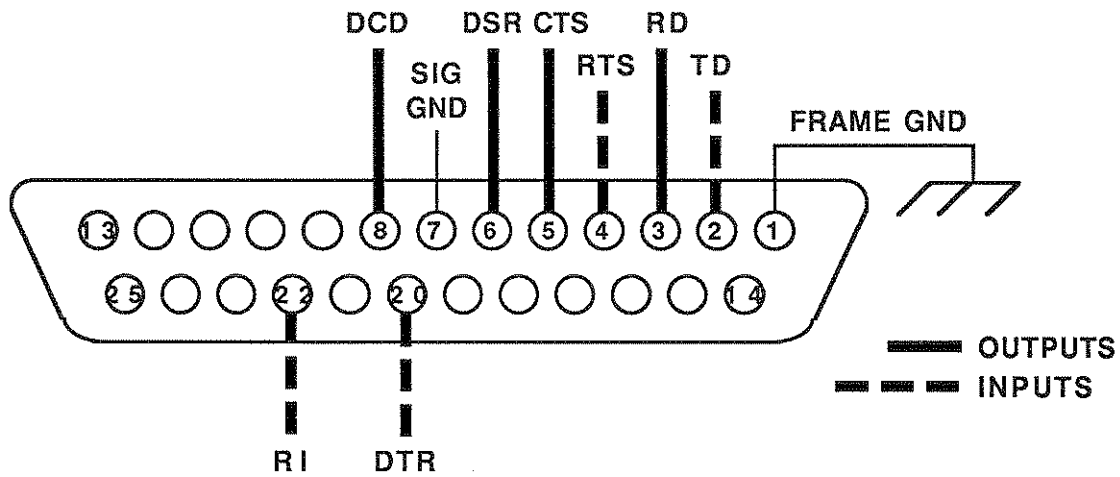

| PIN | TO DTE | TO DCE | NAME | FUNCTION |
|-----|--------|--------|------|---------------------|
| 1 | | | FG | FRAME GROUND |
| 2 | | → | TD | TRANSMITTED DATA |
| 3 | ← | | RD | RECEIVED DATA |
| 4 | | → | RTS | REQUEST TO SEND |
| 5 | ← | | CTS | CLEAR TO SEND |
| 6 | ← | | DSR | DATA SET READY |
| 7 | ← | | SG | SIGNAL GROUND |
| 8 | ← | | DCD | DATA CARRIER DETECT |
| 20 | | → | DTR | DATA TERMINAL READY |
| 22 | ← | | RI | RING INDICATOR |

RS-232C CONNECTOR PINOUTS

FIGURE 6-2

The remaining 15 pins are not connected. **Applying a voltage to pins 1 or 7 will cause damage to the 930A.** The pinouts shown in Figure 6-2 connect directly to a **DTE** (Terminal) or printer. For connection to a **DCE**, a "NULL MODEM" connection, as previously described, must be used.

6-1.1 SELECTING THE REMOTE MODE

To select any of the remote modes, press the **OPTION MENU** key and use the **UP/DOWN** arrow keys to go to Option Menu 3. The display will appear as:

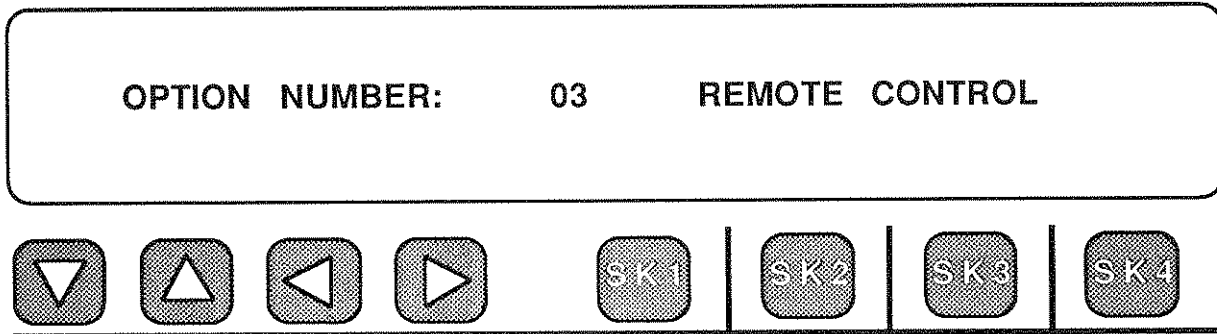

Press any softkey under the display to enter the option:

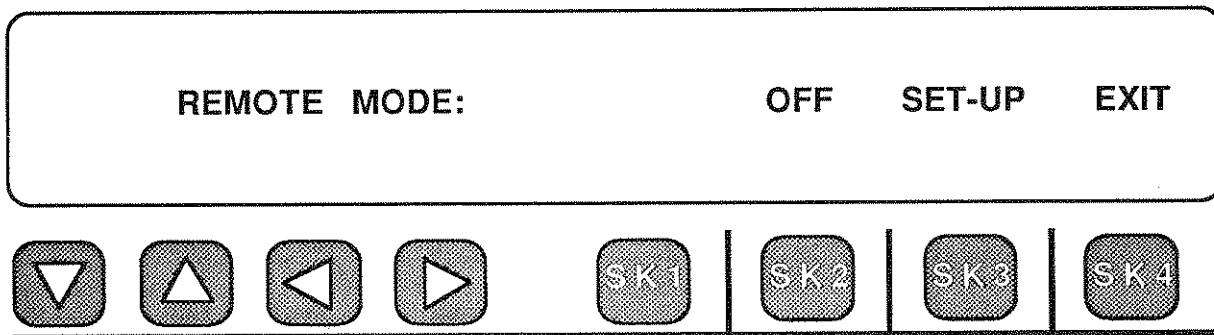

If a Remote mode has already been selected, the current mode will be displayed instead of the word "OFF". Pressing Softkey 2 (under **OFF**) pages through the Remote Modes. The modes available with Option 930A-10C RS-232C Remote are:

- "OFF" ----- Manual control
- "TERMINAL" ----- For use with dumb terminals
- "COMPUTER" ----- For use under computer control
- "PRINTER" ----- Used to drive any serial printer
connected to the RS-232 serial port.

Other modes displayed are custom remote modes for a particular customer. Selecting one of these modes will have no effect if they have not been installed in the unit. Press Softkey 2 until the desired mode appears. Press Softkey 4 (under **EXIT**) and the current mode will be initialized.

Make sure that the current mode is "OFF" to operate the 930A in the manual mode. Pressing Softkey 1, under the words "**REMOTE MODE**", puts the 930A

into **STANDBY MODE**. Use **STANDBY MODE** to operate the 930A manually without losing remote access capability. Press Softkey 1 again to disable **STANDBY MODE**. When the correct remote mode has been selected (either "**TERMINAL**", "**COMPUTER**" or "**PRINTER**"), the 930A's serial interface must be set to match the equipment connected to it.

6-1.2 SETTING THE SERIAL INTERFACE FORMAT

Inside Menu Option 3 (**REMOTE CONTROL**), the main display appears as:

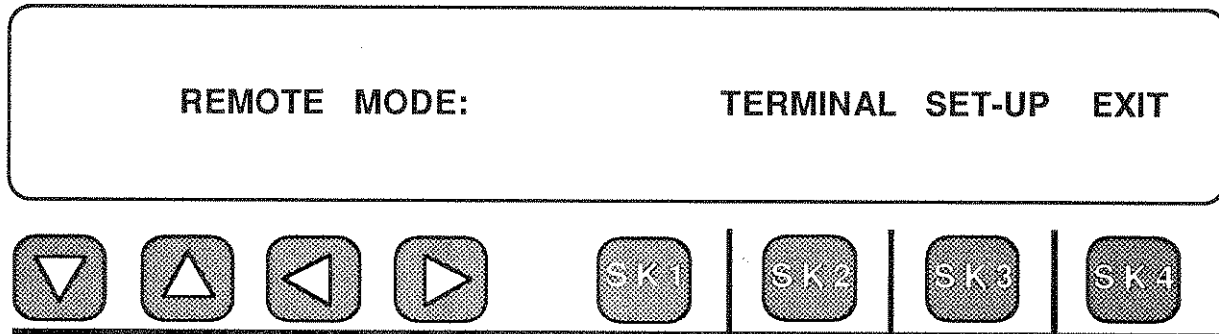

Pressing Softkey 3 (under **SET-UP**) brings up the display shown below:

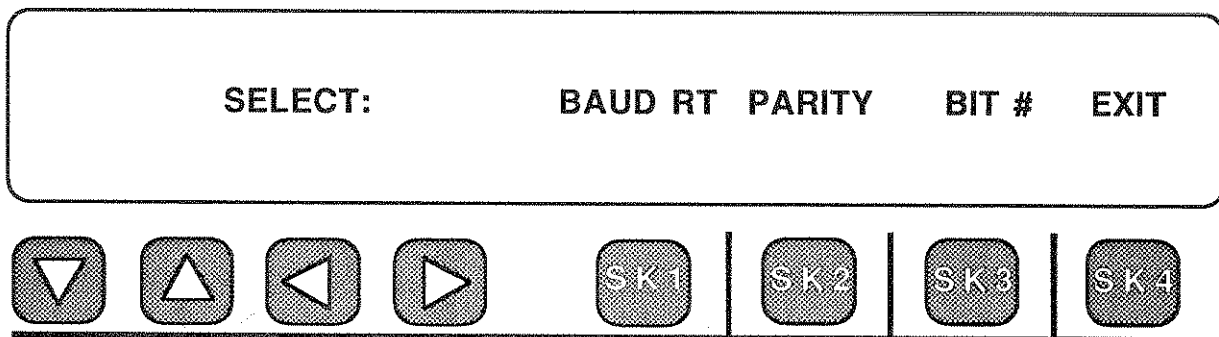

The **SET-UP** menu is used to adjust the baud rate, parity, and number of data bits of the 930A's asynchronous RS-232C serial interface to match the data format of any Terminal, Computer, or Printer connected to the 930A. The settings are retained in non-volatile memory and need not be changed unless a new item of equipment is connected to the 930A. Pressing Softkey 4 (under **EXIT**) exits the menu.

NOTE: The 930A is factory preset to a data format of 9600 baud, even parity, 7 data bits and 1 stop bit. The 930A returns to these defaults if a "**Cold Boot**" is performed. Otherwise, the 930A will retain any new settings you enter, even when power is turned off, until they are changed.

The following step-by-step procedure illustrates the set-up of the data format and is applicable to any of the modes.

EXAMPLE:

Starting from the point at which the **SET-UP** menu is entered by pressing Softkey 3, the main **SELECT** display appears as:

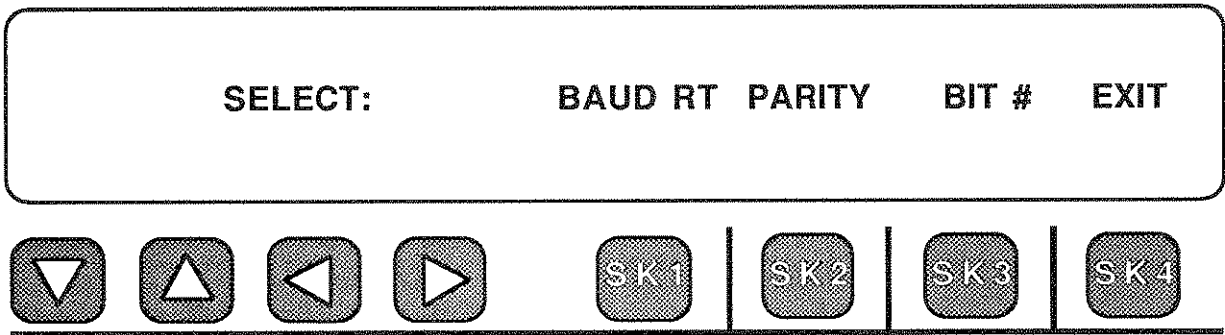

To change the **BAUD RATE**, press Softkey 1 (under **BAUD RT**). An example display is shown below (the rate may differ):

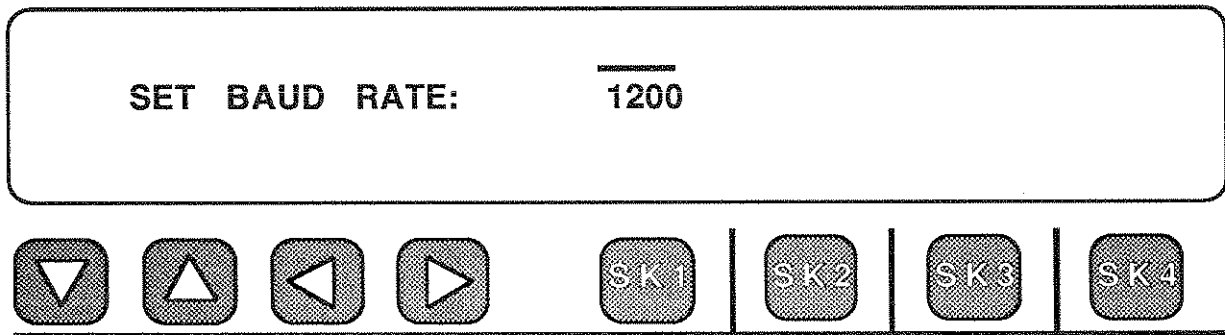

In this example, a value of 1200 baud is shown. If you wanted to keep this rate, you would press the **ENT** (Enter) key, or any softkey, to accept it. **To change the rate**, use the keypad to enter the new value between 110 baud and 9600 baud. **Whenever possible, use the 9600 baud rate to minimize transmission lag.**

To operate at 9600 baud, instead of the 1200 baud displayed, do the following:

Press **9** then **6** then **0** then **0**

The display of the 930A changes to:

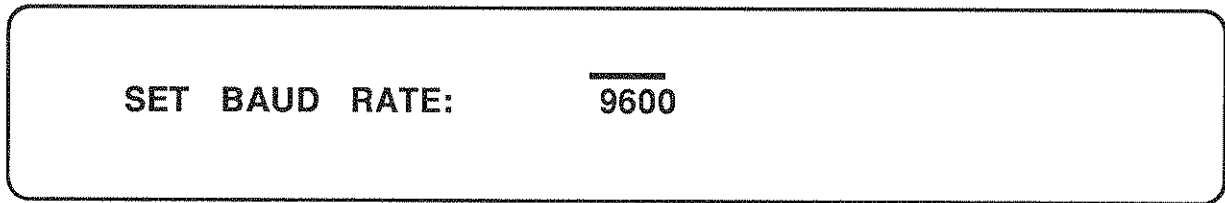

Press **ENT** to enter the rate and return to the Set-Up Menu.



To change the **PARITY**, press Softkey 2 (under **PARITY**) to bring up the following display:

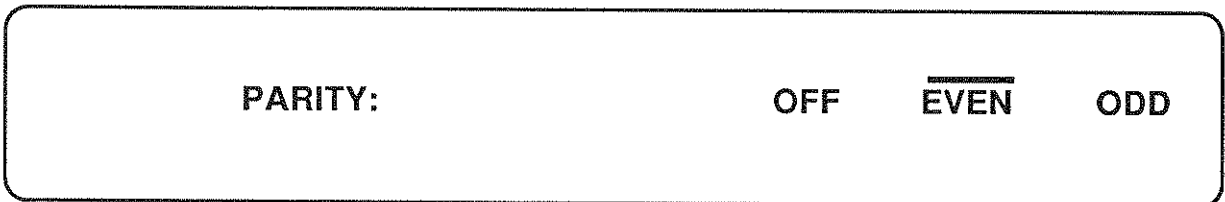

A cursor appears over the current parity state (**EVEN** in this example).

Press Softkey 2 (under **OFF**) for **No Parity**

Press Softkey 3 (under **EVEN**) for **Even Parity**

Press Softkey 4 (under **ODD**) for **Odd parity**

Once you have pressed the softkey under your choice, the 930A will revert to the **SELECT** menu.

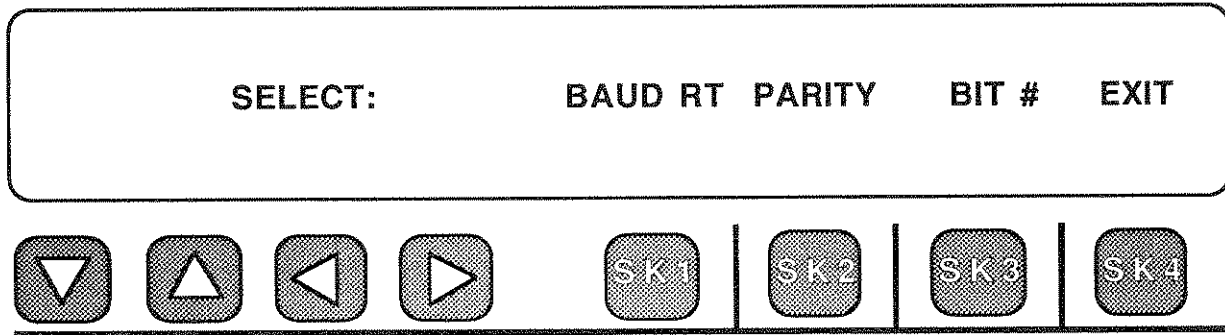

To change the DATA FORMAT, press Softkey 3 (under BIT #) and the following display will appear:

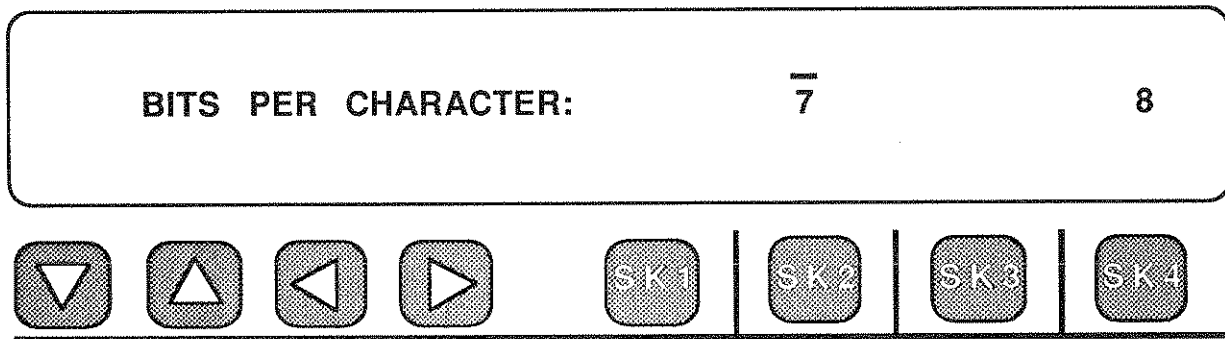

A cursor appears over the currently selected number of data bits ("7" in this example).

The 930A supports ASCII data formats of 7 or 8 bits length, and 1, 1-1/2 or 2 Stop bits. To change the currently selected data format,

Press Softkey 2 (under 7) to select 7 bit ASCII code.
 Press Softkey 4 (under 8) to select 8 bit ASCII code.

NOTE

"Highlighted" characters (those with a cursor above them in the 930A's display) are sent with bit eight (**MSB**) set. Some printers and terminals treat characters with bit eight (8) set as graphics characters. SAGE recommends seven (7) data bit length for use with printers and terminals.

When the appropriate ASCII word length has been selected, the display will advance to read:

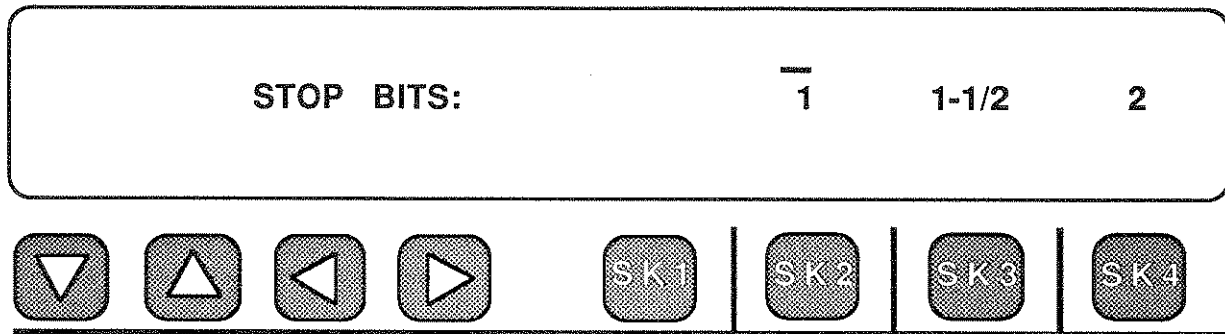

A cursor appears over the currently selected number of stop bits ("1" in this example).

Press Softkey 2 (under 1) to select **1 Stop bit**.

Press Softkey 3 (under 1-1/2) to select **1-1/2 Stop bits**.

Press Softkey 4 (under 2) to select **2 Stop bits**.

One stop bit is the most common setting. The 930A will automatically return to the **SET-UP** menu after the selection has been made.

6-2 USING THE 930A IN THE PRINTER MODE

6-2.1 INTRODUCTION

The Model 930A will work with most commonly available printers provided that the following conditions are met. The printer must have an Asynchronous RS-232C serial input port, print both upper and lower case, be ASCII compatible, and have a carriage width of at least 50 characters (preferably 80 characters). For optimum performance, the printer should accept input at 9600 baud, have at least a 2K buffer, and accept continuous feed paper. Sage Instruments currently recommends the Okidata 182 with Super Speed Serial Interface. You may obtain a printer from Sage by purchasing accessory 9400-0001-01 (80 Column Printer and Cable) if you are unable to obtain one locally.

Care must be exercised when attempting to use printers which do not have buffers. Such printers must be run at a speed at, or below, their print speed multiplied by a factor of 10. That is, an unbuffered printer with a print speed of 30 cps must be run at or below 300 baud, and an unbuffered 120 cps printer would have to be run at, or below, 1200 baud. If your printer cannot keep up with the 930A, switch to a lower baud rate or use one of the printer flow control hand shakes described in section 5-3. Hard copy terminals, such as Teletypes and DECwriters, may also be used as printers, but their low speed tends to degrade 930A performance to an undesirable extent.

While the 930A can be connected to most serial printers without modification or special cables, experience has shown that printers vary widely in terms of interface requirements. Some may require special cables or an adaptor. Refer back to Figure 6-2 for the pinouts of the 930A serial interface.





6-2.2 SETTING-UP THE PRINT FUNCTION

The procedure for setting up the 930A to work with a serial printer is similar to the procedure for setting up any of the remote operating modes. For this reason a brief review of the general set-up procedure follows:





- 1) Turn on the 930A, set-up the correct Trunk Type and any test functions desired. (Refer to Section 5).
- 2) Press the **OPTION MENU** key, page to Menu Option 3 (Remote Control), and set the mode to "**OFF**" (Refer to Section 6-1.1 as necessary). Exit back to the main Option Menu by pressing Softkey 4 (under **EXIT**). This step prevents inadvertent dumping of data to the printer and filling up its buffer before you are ready to print.
- 3) Turn on the Printer and connect its cable to the 930A serial port.
- 4) Press the **OPTION MENU** key and enter Menu Option 3 by pressing any softkey under the display.
- 5) Once inside Menu Option 3, press Softkey 3 (under **SET-UP**).
- 6) If the printer's data format is not known, it can be determined from it's operating instructions. Set the 930A's baud rate, parity, character size and stop bits to match those of the printer (Refer to Section 5-1.2 as necessary).
- 7) Once the data format has been set correctly, and the 930A has returned to the Remote Control menu, press Softkey 2 until the display reads "**PRINTER**".
- 8) Exit from the Remote Control menu by pressing Softkey 4

(under **EXIT**) and the Printer mode will be initialized.





At this point, you will be asked a series of questions by the 930A regarding what parameters are to be printed out. These questions are:

| | | | | | | | |
|---|---|---|---|------|------------------------|------|------|
| PRINT ERRORS? | | | | YES | $\overline{\text{NO}}$ | | |
|  |  |  |  | SK 1 | SK 2 | SK 3 | SK 4 |

To print PCM errors, whenever they occur, press Softkey 3 (under **YES**), otherwise press Softkey 4. In either case the 930A display will advance to the next question, which is:





| | | | | | | | |
|---|---|---|---|-------------------------|------|------|------|
| PRINT RECEIVED RECORDS? | | | | $\overline{\text{YES}}$ | NO | | |
|  |  |  |  | SK 1 | SK 2 | SK 3 | SK 4 |

To print calls captured by the digit receiver, press Softkey 3 (under **YES**). Press Softkey 4 if this printout is not wanted. If you answer **YES**, the display advances to:

| | | | | | | | |
|---|---|---|---|-------------------------|------|------|------|
| PRINT DIGIT ANALYSIS? | | | | $\overline{\text{YES}}$ | NO | | |
|  |  |  |  | SK 1 | SK 2 | SK 3 | SK 4 |

To print the analysis of the received digits, press Softkey 3 (under YES), otherwise, press Softkey 4.

The 930A display advances to the next question which is:

| | | | | | | | |
|---|---|---|---|------|------|------|------|
| PRINT WINK TIMING? | | | | YES | NO | | |
|  |  |  |  | SK 1 | SK 2 | SK 3 | SK 4 |

To print the wink timing measurements, press Softkey 3, otherwise press Softkey 4. When the questions have been answered, you may **exit** from this Menu Option. The printer will begin to print whenever one of the conditions occurs, or if the **ENT** (Enter) key on the 930A is pressed. Press the ENT key to test your connection. If the output is garbled, adjust the baud rate, parity, or number of bits. To suspend printing for any reason, without taking the 930A out of the Printer mode, simply turn off the printer power.

NOTE: Taking the printer "Off-Line" may not have the desired effect since it's buffer may fill up with unwanted material which will be printed out when the printer is placed back "On Line".

6-2.3 PRINTER HAND SHAKE

Menu Option 89: PRINTER HANDSHAKE, allows you to select a form of flow control when the 930A sends data to the printer. This allows the printer to tell the 930A to stop sending when the printer's buffer is full or the printer is off-line. The factory default setting for the 930A is no flow control (handshake **OFF**), as it is not usually necessary.

If your printer misses characters sent by the 930A, especially during long printouts such as digit analysis or T-1 BERT history, select a lower baud rate or use Menu Option 89 to select a form of flow control.

The 930A supports **DTR** and **XON/XOFF** protocols. Press the **OPTION MENU** function key and use the **UP/DOWN** arrow keys to get to **Menu Option 89: PRINTER HANDSHAKE**. Press any softkey under the display to enter the menu. You will see a display like the one shown on the following page.

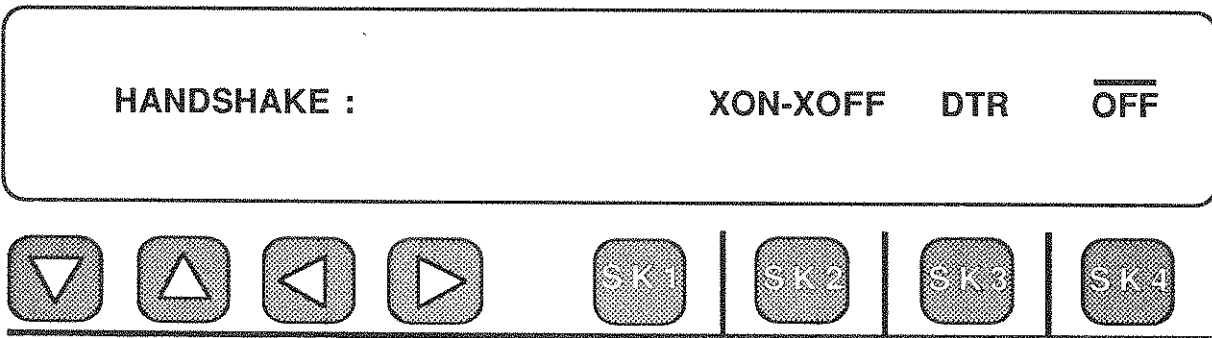

The factory default is **OFF** (no handshake). This allows the 930A to send to any serial device, even if only pins 2, 3, and 7 are connected on the serial cable. If this choice is not highlighted already, you may select it by pressing Softkey 4. Cold-booting the 930A will also restore this setting.

When **DTR** handshaking is selected, the 930A will send characters to the printer only when it sees positive voltage on **DTR** (pin 20). If your printer is off line, powered down, or has a full buffer, it will not provide this voltage and the 930A will "hang" when attempting to print. This allows the printer to "catch up" by printing the contents of its buffer while the 930A waits. You will probably need to enable **DTR** handshaking on your printer by using a DIP switch. The printers supplied by SAGE are shipped with **DTR** handshaking enabled. Press Softkey 3 (under **DTR**) to enable **DTR** handshaking for the 930A.

When **XON-XOFF** handshaking is enabled, the 930A will stop sending characters to the printer when it receives the **XOFF** character (**CNTRL-S**) from the printer. It will resume sending characters when it receives the **XON** character (**CNTRL-Q**). **XON-XOFF** protocol is useful when communicating over modems or other media which do not allow a separate hardware handshake, such as the **DTR** line. Some printers support **XON-XOFF** handshaking, as do most terminals and modems. Some modems can be set to convert **DTR** handshaking to **XON-XOFF**. To set the 930A to **XON-XOFF** handshaking, press Softkey 2.

When the 930A attempts to send characters and the handshake fails (there is no voltage on **DTR** or an **XOFF** character was received without an **XON**), it "hangs" until either the handshake succeeds or ten seconds have passed. If ten seconds pass without a successful handshake, the 930A turns the handshake **OFF** and proceeds normally. If a handshake fails because a printer is turned off or left off line when the 930A needs to print, you will need to re-enable the handshake by using Menu Option 89 again. As long as the

handshake is successful, the handshake protocol is stored in battery backed RAM and will remain set.

6-2.4 PRINTER APPLICATIONS

You can obtain a hard-copy printout of the 930A display line by pressing the **ENTER** key. This key rarely affects the display or operation of the 930A. The printout will contain a time and date stamp.

Currently, four types of information can be set to print out spontaneously without a key press. These are : Errors, Received Digits, Digit Analysis and Wink Timing. As more options become available this list will be expanded. **NOTE:** The results of **ROTL/Responder** tests, frequency sweep and envelope delay measurements will be printed out automatically as they occur, if the 930A is in **PRINTER** remote mode. The 930A will also print out automatically when left in the **SUPERVISION MONITOR** mode (Menu Option 8) every 4 hours, or whenever its buffer is full.

If error reporting is selected, all detected PCM errors will be time stamped and printed out as they occur. The 930A can be left to monitor a PCM channel overnight and a full error audit will be available in the morning. If received record reporting is selected, received calls will be printed out whenever a Digit Receiver sequence is completed, or whenever the originating end abandons the call (goes **On Hook**) in mid-sequence. The number of calls, frequency of inter-LATA vs. intra-LATA calls, the number of incomplete **ANI**

sequences, and abandoned calls can all be determined from the 930A's reports. All reports include a time and date stamp. If Digit Analysis has also been selected, the frequency and amplitude of each **MF** or **DTMF** tone is displayed together with the Interdigit time, and any spurious tones as well. **Dial Pulse** digits are analyzed in terms of % Break, Pulses per second and Interdigit time.

If Wink Timing reporting is selected, wink timing information will be printed out whenever a record sequence is complete, a call is abandoned, or a wink fails. The 930A times supervision events such as winks when it **SENDS** digits or when it receives digits in **MONITOR** mode. When the 930A acts as a terminating digit receiver, it provides the winks rather than timing them. Wink timing printouts can show the time between line seizure and the first wink, the length of all winks, the time between the end of a digit sequence and a wink, and the time between call completion and answer supervision. The 930A can monitor these parameters on all calls over a given PCM channel, or analog trunk, completely unattended.

6-2.4 PRINTER REPORT FORMATS

This section provides report format details and examples of 930A printouts for the various types of information.

PCM ERROR REPORTS:

Description: The label "**PCM1:**," followed by one blank, the error detected on **PCM1** (if any), the label "**PCM2:**," and the error detected on **PCM2** (if any). An error report is a 40 character string terminated by a line feed and carriage return. The error report will have the following form:

| PCM1: NOPCM! | PCM2: NOPCM! |
|---------------------|---------------------|
| FRAMELOSS | FRAMELOSS |
| FRAMEERROR | FRAMEERROR |
| SLIP | SLIP |
| BIPOLAR VIO | BIPOLAR VIO |
| REMOTEALARM | REMOTEALARM |
| BLUE ALARM (ESF) | BLUE ALARM (ESF) |
| CRCERROR(ESF) | CRCERROR(ESF) |
| >15ZEROS | >15ZEROS |

RECEIVED RECORD REPORTS:

A report may consist of up to four received records. Each record is a string of 40 characters terminated by a line and feed carriage return. The final record is followed by an additional carriage return and line feed. Each record takes the form:

0123456789#*ABCD REC#N HOLD DTMF

Description: There is a 17 character record field, followed by the label "REC#", the record number (1-4), three blanks, the word "HOLD", three blanks, and the label "MF", "DTMF" or "DP". Dial Pulse records can be digits from 0 to 9. DTMF records can be all digits from 0 to 9 plus the characters "A", "B", "C", "D", "*", and "#". MF records may include, in addition, the characters "KP", "ST", "STP", "ST2P", and "ST3P". There are no spaces between

characters and records containing less than 17 characters are preceded by blanks.

WINK TIMING REPORTS:

Wink timing reports will include all completed or interrupted supervision events from the last record sequence received. Each supervision event is sent as three strings. Each string is terminated by a line feed and carriage return. The first string takes the form:

EVENT #N

It is six characters in length and all supervision events (Winks, Off-Hooks, and Delays) are preceded by this string. The second string takes the form:

| | | | |
|------------------|---------|------|-------|
| W 01 W 02 03 W H | NNNN | MSEC | GUARD |
| (any sequence) | >16,000 | MSEC | |
| | >60,000 | MSEC | |

The record sequence is printed first and may be up to 17 characters long (shorter sequences are preceded by blanks). The length of the Guard period in milliseconds, or a time-out indicator, followed by the word "GUARD" is printed out next. This string is 40 characters long. The third string takes the form:

| | | | |
|------------------|------|------|---------------------|
| W 01 W 02 03 W H | NNNN | MSEC | WINK (any sequence) |
| | >200 | MSEC | OFF-HOOK |

The record sequence is printed first, and may be up to 17 characters long (shorter sequences will be preceded by blanks). Next, the length of the event in milliseconds, or a time-out or failure indicator, followed by an event type label is printed out. This string is also 40 characters long. The final supervision event in the report is followed by an additional line feed and carriage return.

NOTE: If more than one type of data is included in an output, the 930A will print them out in the following order: Errors, Received Records and then Wink Timing.

6-3 OPERATION IN THE TERMINAL MODE

The Model 930A currently supports the Televideo family of terminals (the Televideo 910, 910+, 912, and 925), those terminals which can be set to emulate Televideo such as ADM, WYSE, and Hazeltine to name a few, and the VT-100 family of terminals. The former are so-called "Dumb" terminals, as distinguished from intelligent terminals, and are relatively inexpensive.

The VT-100 terminals are semi-intelligent types. The 930A supports not only the VT-100 family, but also those terminals that emulate the VT-100. Since the VT-100 is ANSI standard, any ANSI terminal can be used.

If you have a choice between Televideo and VT-100 emulation, choose Televideo. It is faster and will allow you to use your terminal cursor keys to control the 930A's UP/DOWN and LEFT/RIGHT arrow keys.

Terminal emulation programs such as CROSSTALK[®] and PROCOMM[®] allow a PC to operate the 930A in Terminal Mode. The SAGE STARMAC[®] Macro-language program also allows you to operate the 930A in Terminal mode.

The 930A does not currently support Teletypes or other "hard copy only" terminals such as DECwriters, except in PRINTER remote mode (Refer to Section 6-2 for details).

****CROSSTALK and PROCOMM are registered trademarks****

6-3.1 TERMINAL SET-UP

To use the Model 930A from a terminal, follow the standard set-up procedure outlined in Section 6...-1.2 **SETTING THE SERIAL INTERFACE FORMAT** and Section 6-2.2 **SETTING-UP THE PRINT FUNCTION**. The procedure for setting up the data format of the 930A's serial port is identical for all remote modes. The steps are: Set the 930A Remote Mode to **OFF**, connect the terminal, set the 930A's baud rate, parity, character size, and stop bits to match the terminal's data format. Set the 930A's Remote Mode to **TERMINAL**. The 930A display will appear as shown below:

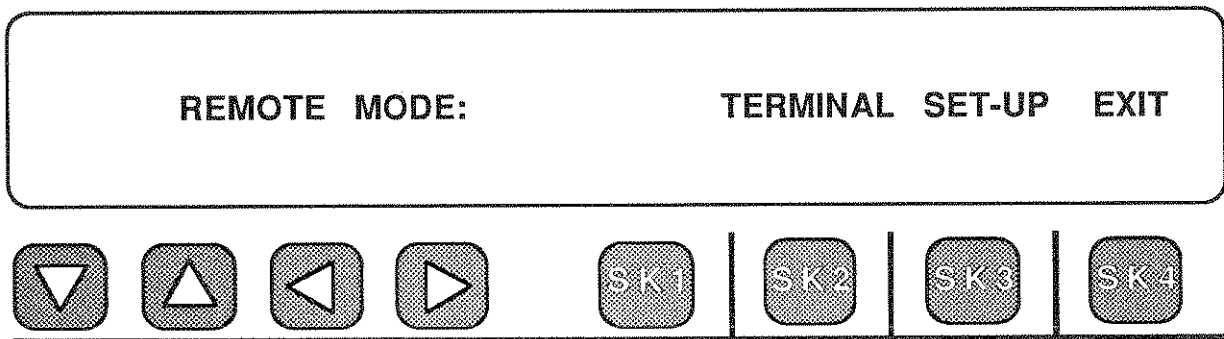

Press Softkey 4 (under **EXIT**). The 930A display will present two choices of terminal emulation as shown below:

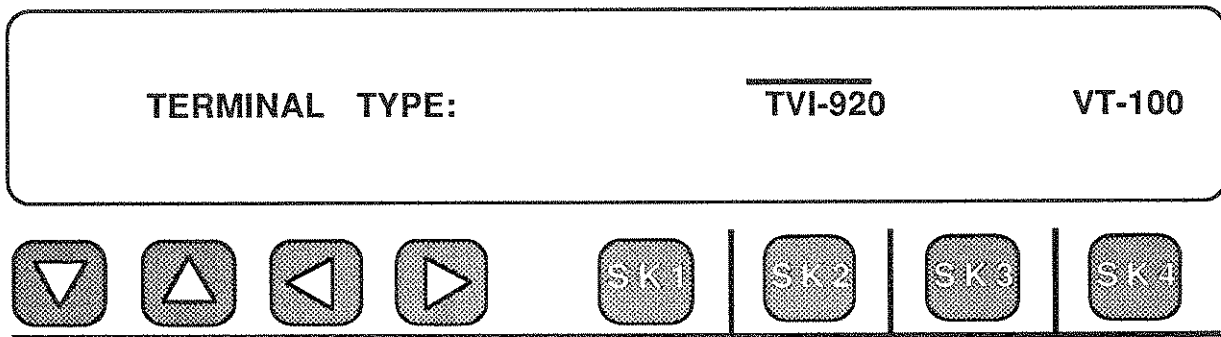

A flashing cursor will appear over the previous Terminal emulation type used (a TVI-920 in this example). Press Softkey 2 to use Televideo 920 (or similar terminal), or Softkey 4 for DEC VT-100 terminal usage. The 930A display will immediately return to the Menu Option display as shown on the following page.

OPTION NUMBER: 03 REMOTE CONTROL



The display which should appear on the Terminal's CRT will be somewhat like that shown in Figure 6-3 below.

 SAGE INSTRUMENTS 930A

 NORMAL LOOP TERM CONTACT 2W 900 o t (Current Trunk Type)
 [J] [K] [L] [;] ORIG TERM

- A) TRUNKTYPE
- B) DIAL/RING
- C) RETURNLOSS
- D) SENDTONE
- E) MEASTONE
- F) MEASNOISE
- G) OPTIONS

UPPERCASE O) GOOFFHOOK ?) HELP CR) ENTER SP) CLEAR
 Lowercase o) GOONHOOK S) STO R) RCL N) RCLNEXT

When sending digits:
 To send: 0 1 2 3 4 5 6 7 8 9 - KP ST STP ST2P ST3P +/-
 Type: 0 1 2 3 4 5 6 7 8 9 - * # a b c d

 TERMINAL CRT DISPLAY

FIGURE 6-3

NOTE: The line marked "Current Trunk Type" will show the trunk type currently selected in the 930A.

6-3.2 TERMINAL KEYS

The commands

Each key on the 930A's front panel is mapped to a key on your PC's keyboard. Pressing a key on your PC has the effect of pressing the equivalent key on the 930A. Consequently, anything you can do with the 930A manually can also be done remotely. All legal commands are listed on the screen, and all measurements are returned immediately and updated continuously. There are no opcodes to learn. Technicians familiar with the manual operation of the 930A will learn to operate it in terminal remote mode in a day or two at most.

Front panel keys and their ASCII equivalents

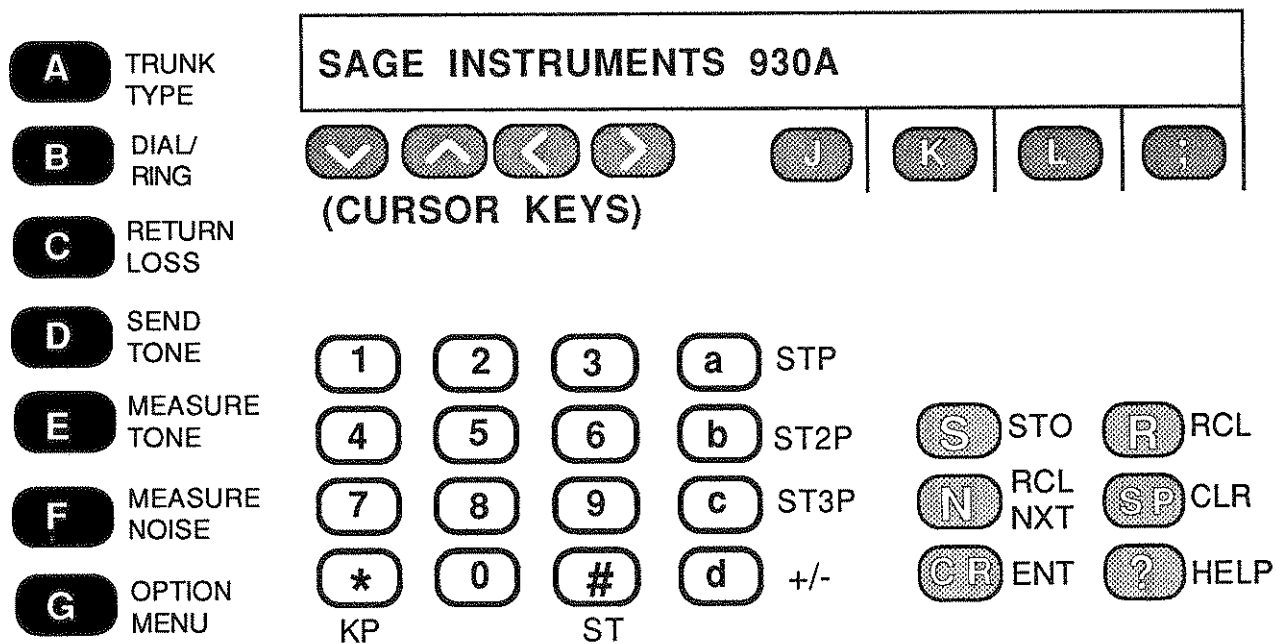

Type Uppercase "O" to go Off hook, lowercase "o" to go on hook.

The **main function keys** on the 930A (the black keys along the left edge of the front panel) are mapped to the uppercase letters "A" through "G". "A" is the Trunk Type key, "B" is Dial/Ring, "C" is Return Loss, "D" is Send Tone, "E" is Measure Tone, "F" is Measure Noise and "G" is the Option Menu key.

Note: The 930A uses almost exclusively uppercase commands, so it is a good idea to enable the CAPS LOCK on your PC. To send the lowercase "a", "b", "c" or "d" with CAPS LOCK on, just press either SHIFT key along with the letter.

The **cursor keys** (the arrow keys below the 930A's display) are mapped to the cursor keys on your PC. Be sure NUM LOCK is off, or your PC "cursor keys" will act as number keys instead. You may also use Ctrl-J for down, Ctrl-K for up, Ctrl-H for left and Ctrl-L for right, and leave NUM LOCK on. If you have the enhanced AT keyboard (101 keys), you have a second set of cursor keys that are unaffected by NumLock.

The four unlabeled **soft keys** below the 930A's display are mapped to the "J", "K", "L" and ";" keys on your PC. Touch typists will recognize these as the "home" keys for the right hand. These four adjacent keys, left to right, map to the four adjacent softkeys on the 930A, also left to right, as shown in the illustration on the preceding page. These softkeys generally select or change the fields shown above them on the 930A's display.

The **numeric keypad** digits 0-9 map to the digits 0-9 on your PC's keyboard. You may use a separate keypad, use the integrated keypad and NUM LOCK, or use the digits 0-9 along the top of any PC's keyboard (If you use NUM LOCK and the integrated keypad, you will lose the use of your cursor keys while NUM LOCK is on). The KP/* key is mapped to your PC's asterisk (*) key. The ST/# key is mapped to your PC's pound (#) key. The A/STP key is mapped to lowercase "a". Similarly, the B/ST2P, C/ST3P and D/+/- keys are mapped to lowercase "b", "c" and "d".

The **special function keys** (the light gray keys in the center of the 930A front panel) are mapped as follows: "S" is for Store (STO), "R" is for Recall (RCL), "N" is for Recall Next (RCL NXT), the Space Bar is for Clear (CLR), the ENTER key is for Enter (ENT) and the Question Mark (?) is for Help (HELP).

The **hook switch** is mapped to the "O" key. Uppercase "O" tells the 930A to go Off hook. Lowercase "o" tells the 930A to go on hook. The display above the word "ORIG" on the PC's screen should echo your command, showing uppercase "O" when the 930A is Off hook and lowercase "o" when it is on hook.

6-3.3 TERMINAL CRT DISPLAY

Most of the CRT is dedicated to displaying a **HELP** screen. Only one line of the CRT changes to indicate the status of the 930A. It is set off from the others by a dotted line. It always echoes the display on the 930A front panel. In the example of Figure 5-3 the line was:

```
-----  
NORMAL LOOP TERM CONTACT 2W 900 o t  
-----
```

The "[J] [K] [L] [;]" below the changing display line in Figure 5-3 is meant to reflect the position of the four softkeys under the 930A front panel display. The equivalent keys on the terminal ("J", "K", "L", and ";") line up below the functions, just as Softkeys 1-4 do on the 930A. A Softkeys function is indicated by the display above it. The entire display line, using Figure 5-3 as an example, looks like:

```
-----  
NORMAL LOOP TERM CONTACT 2W 900 o t  
[ J ] [ K ] [ L ] [ ; ] ORIG TERM  
-----
```

A portion of the display line has the words **"ORIG"** and **"TERM"** beneath it.

These fields show the condition of the 930A's supervision lamps. The lowercase "o" and "t" in the display above indicate that both the originating and terminating ends are "On Hook". An uppercase "O" or "T" indicates an "Off Hook" condition at the originating or terminating end. A "-" in either location means "no indication", and generally signifies an incomplete or faulty circuit.

6-3.4 TROUBLESHOOTING

SYMPTOM: Terminal CRT remains blank.

PROBABLECAUSE: Faulty or improper RS-232 cable connection.

APPROACH: Check cables, power to the terminal, and RS-232 pinouts.

SYMPTOM: Terminal prints gibberish.

PROBABLECAUSE: Incorrect data format.

APPROACH: Turn terminal off. Set 930A Remote Mode to "OFF". Check 930A baud rate, parity, character size, and stop bits. Check terminal DIP switches to be sure of it's data format. Turn terminal on. Set the 930A remote mode to "TERMINAL" and press Softkey 4 to "EXIT".

SYMPTOM: The 930A does not respond to terminal commands.

PROBABLECAUSE: Bad mechanical connection or CAPS LOCK not down.

APPROACH: For mechanical condition, check the cables and connectors (broken pins), power, and RS-232 pinouts. For CAPS LOCK be sure that Uppercase commands are being sent when intended. The 930A uses only a few lowercase commands so the CAPS LOCK key on the terminal should generally be down.

SYMPTOM: 930A responds to some commands but not others.

PROBABLECAUSE: Broken lead in RS-232 cable or wrong data format.

APPROACH: For data format, refer back to the "gibberish" symptom. Be sure parity and number of bits are correct. Test the RS-232 cable with an ohmmeter or by replacing with another cable.

6-4 COMPUTER OPERATION

6-4.1 INTRODUCTION

The 930A can be operated under the control of any computer capable of sending and receiving serial ASCII characters over an RS-232 link. Each character sent to the 930A is treated as a keystroke from the 930A's front panel. A single ASCII character has been selected to represent each key on the front panel of the 930A. Sending the ASCII character is the equivalent of pressing the 930A key associated with it. For example, sending the Uppercase ASCII character "A" is the same as pressing the Trunk Type Function key. Writing a program for the 930A is just like writing a program for a programmable calculator. That is, do the operation manually and write down the key sequence. Then translate the key sequence into an ASCII string. Sending the string causes the operation to be performed. Refer to Table 6-1 for ASCII to front panel conversions as well as HEX and Decimal equivalents.

It is strongly recommended that the Terminal mode be used when writing or debugging programs intended for use in the Computer mode. Terminal mode is fully interactive and comes with on-screen **HELP**.**

There are a few ASCII characters (H, s, m, W, X, Y and Z) that will cause the 930A to perform special functions that are only performed remotely. These characters do not correspond to any keys on the 930A front panel. Refer to Table 6...-2 for details.

** To operate the 930A in Terminal Mode from a PC, use a terminal emulation program such as CROSSTALK, PROCOMM, or STARMAC.

TABLE 6-1
ASCII TO FRONT PANEL KEY CONVERSION

| ASCII CHARACTER | 930A FUNCTION | HEX CODE | DECIMAL CODE |
|-------------------|--------------------|----------|--------------|
| A | Trunk Type | 41 | 65 |
| B | Dial/Ring | 42 | 66 |
| C | Return Loss | 43 | 67 |
| D | Send Tone | 44 | 68 |
| E | Measure Tone | 45 | 69 |
| F | Measure Noise | 46 | 70 |
| G | Option Menu | 47 | 71 |
| RETURN | Enter | 0D | 13 |
| SPACE | Clear | 20 | 32 |
| ? | Help | 3F | 63 |
| S | Store | 53 | 83 |
| R | Recall | 52 | 82 |
| N | Recall Next | 4E | 78 |
| d | Change Sign (+/-) | 64 | 100 |
| - | Pause (Left Arrow) | 2D | 45 |
| Uppercase O | Go Off Hook | 4F | 79 |
| Lowercase o | Go On Hook | 6F | 111 |
| J | Softkey 1 | 4A | 74 |
| K | Softkey 2 | 4B | 75 |
| L | Softkey 3 | 4C | 76 |
| ; | Softkey 4 | 3B | 59 |
| ^H (Left Cursor) | Left Arrow | 08 | 8 |
| ^L (Right Cursor) | Right Arrow | 0C | 12 |
| ^K (Up Cursor) | Up Arrow | 0B | 11 |
| ^J (Down Cursor) | Down Arrow | 0A | 10 |

| TO SEND | TYPE | HEX | DEC | TO SEND | TYPE | HEX | DEC |
|---------|------|-----|-----|---------|------|-----|-----|
| 0 | 0 | 30 | 48 | * | * | 2A | 42 |
| 1 | 1 | 31 | 49 | # | # | 23 | 35 |
| 2 | 2 | 32 | 50 | A | a | 61 | 97 |
| 3 | 3 | 33 | 51 | B | b | 62 | 98 |
| 4 | 4 | 34 | 52 | C | c | 63 | 99 |
| 5 | 5 | 35 | 53 | D | d | 64 | 100 |
| 6 | 6 | 36 | 54 | KP | * | 2A | 42 |
| 7 | 7 | 37 | 55 | ST | # | 23 | 35 |
| 8 | 8 | 38 | 56 | STP | a | 61 | 97 |
| 9 | 9 | 39 | 57 | ST2P | b | 62 | 98 |
| | | | | ST3P | c | 63 | 99 |

TABLE 6-2
SPECIAL ASCII CHARACTERS FOR REMOTE CONTROL

| CHARACTER | FUNCTION | HEX | DEC |
|-----------|---|-----|-----|
| H | Causes the 930A to send a copy of it's terminal HELP screen (See Figure 5-3) to the remote computer or terminal. | 48 | 72 |
| m | Causes 930A to send "Hang-Up" string to a Hayes compatible MODEM. | 6D | 109 |
| s | Places 930A in "Standby Mode". | 73 | 115 |
| W | Causes the 930A to report all pending PCM errors, received records, wink timing information or 105 test results to the host computer. Information is "pending" when an ALERT has been sent but no REPORT has been requested. | 57 | 87 |
| X | Interrupts the 930A and causes it to send an immediate copy of it's current display line to the host computer. This command is not buffered and executed in turn. It is executed at once. | 58 | 88 |
| Y | Causes the 930A to send a copy of it's current display line to the host computer. This command is buffered and executes after all previous commands have been completed. | 59 | 89 |
| Z | Causes the 930A to send a copy of it's current display line after it determines that a valid measurement has been made. A series of consecutive "Z" commands will cause the 930A to send consecutive measurements to the host computer. | 5A | 90 |

NOTES: The "X", "Y", and "Z" commands all cause the 930A to send a copy of it's display line to the host computer.





The "X" command executes immediately and can be used to find the current status of the 930A. This allows "spot checking" progress through a command sequence at any time.

The "Y" command tells the 930A to send a copy of it's display line when it reaches a certain point in the command sequence. This can be used to obtain a measurement or start a timer in the host.





The "Z" command is like the "Y" command, except that successive "Z" commands will each be delayed by one measurement period.

6-4.2 SETTING-UP THE COMPUTER MODE

The set-up procedure for the Computer Mode of the 930A is the same as outlined in Sections 6-1.2 and 6-2.2. To review: set the 930A's Remote Mode to **OFF**. Connect the computer to the 930A serial port. Use the **SET-UP** menu to set the 930A's baud rate, parity, character size, and stop bits. Set the Remote Mode to **COMPUTER** and press **EXIT**. The 930A will ask the following questions:

| | | | | | | | |
|---|---|---|---|-----|------------------------|-----|-----|
| REPORT ERRORS? | | | | YES | $\overline{\text{NO}}$ | | |
|  |  |  |  | SK1 | SK2 | SK3 | SK4 |

Press Softkey 3 (under **YES**) to have the 930A alert the host computer when it detects PCM errors. Press Softkey 4 if no alert for PCM errors is required. The display will advance to the next question:

| | | | | | | | |
|---|---|---|---|-------------------------|-----|-----|-----|
| REPORT RECEIVED RECORDS? | | | | $\overline{\text{YES}}$ | NO | | |
|  |  |  |  | SK1 | SK2 | SK3 | SK4 |

Press Softkey 3 (under **YES**) to have the 930A alert the host computer upon completion, or interruption, of a Digit Receiver sequence. Otherwise, press Softkey 4. If you answer **YES** the 930A display automatically advances to the next question.

| | | |
|-------------------------------|------------|-----------|
| REPORT DIGIT ANALYSIS? | <u>YES</u> | NO |
|-------------------------------|------------|-----------|



Press Softkey 3 (under **YES**) to have the 930A append an analysis of the received digit amplitudes, frequencies, On and Off times, % Break, Rate and Interdigit Time to the report on received digits. Press Softkey 4 if the analysis is not wanted. This screen does not appear if you answered **NO** to the question: "REPORT RECEIVED RECORDS?".

| | | |
|----------------------------|------------|-----------|
| REPORT WINK TIMING? | <u>YES</u> | NO |
|----------------------------|------------|-----------|



Press Softkey 3 (under **YES**) if the 930A is to alert the host computer when it has Wink Timing information available. Otherwise, press Softkey 4.

The 930A display should then read:

| |
|--------------|
| READY |
|--------------|



A prompt will be sent to the host computer to indicate that the 930A's command buffer is empty and the 930A is awaiting instructions.

6-4.3 INPUT TO THE 930A

Input to the 930A is in the form of "command strings". These are strings of ASCII characters that the 930A recognizes as commands. A command string may be from 1 to 40 characters in length. The 930A has a 40 character input buffer. Tables 6-1 and 6-2 contain summaries of these commands and Section 5-3.2 describes them.

The 930A will echo each character back to the computer as it is received and placed in the buffer. **DO NOT SEND THE NEXT CHARACTER UNTIL THE ECHO HAS BEEN RECEIVED.** This is the 930A input protocol (actually a handshake). The 930A executes the commands in the order they are received, with the exception of the "X" character, which executes immediately. When all received commands have been executed, and the input buffer is empty, the 930A will signal the host computer with a ">" prompt.

The 930A will echo and ignore any characters it does not recognize as commands. No error message is sent back.

6-4.4 OUTPUT FROM THE 930A

Output from the 930A consists of the following:

ECHOES --- The 930A echoes all received characters to the host computer.

PROMPTS - When the 930A has executed all received commands, and its command buffer is empty, it sends a prompt consisting of a line feed, carriage return, and a ">" character. The ASCII sequence in Hexadecimal code is 0A 0D 3E. Some data strings include the ">" character, but the 0D 3E sequence is unique.

ALERTS -- Under certain circumstances, the 930A will send a "bell" character (ASCII 07) to alert the host computer that it has something to report. Any programs the user writes should screen all 930A output carefully for this character. If the Beep on Error feature (Menu Option 15) is turned "OFF", no bell character will be sent.

DATA ---- When the 930A executes an X, Y, or Z command, it sends a copy of it's current display line and supervision status. This is a 50 character line terminated by a line feed and carriage return. Section 6-4.5 contains details of display line formats.

REPORTS - If the 930A has sent the host computer an **ALERT**, it will respond to the "W" command with a report concerning what caused the **ALERT**. This could be a PCM error, a completed Receive Record sequence, Wink Timing information, 105 test results or some combination of the four. Section 6-2.4 contains further details of Report Formats. When used as a Near End Responder (Menu Option 26), the 930A will send an alert (Bell) at the completion of each test.

6-4.5 DISPLAY LINE FORMATS

A Display Line is always 50 characters long, terminated by a carriage return and line feed. The first 40 characters of a Display Line mirror the display on the front panel of the 930A. The next 4 characters are ASCII blanks. The forty-fifth character shows originating supervision. The next 4 characters are ASCII blanks. The fiftieth character shows terminating end supervision. Typical example displays of the computer's CRT are provided.

TYPICAL CRT DISPLAYS:

MEASURE TONE:

| | | | | | | |
|---------|-------|------|---------|------|---|---|
| NNNN Hz | +NN.N | dBm0 | AVERAGE | PCM1 | O | T |
| ---- | OVER | dBm | RMS | PCM2 | o | t |
| | ---- | dB | | T1R1 | - | - |
| | ---- | dB | | TR | - | - |

Description -- Seven leading blanks, followed by the frequency in Hertz or four dashes, the label "Hz ", a signed level or the over or under indication ("OVER" or "----"), the relative zero label, the "AVERAGE" or "RMS" label, and the signal source label.

MEASURE NOISE:

| | | | | | | |
|------|-------|---------|------|---------|---|---|
| +NNN | dBrn0 | C-NOTCH | PCM1 | CHANNEL | O | T |
| | dBrn | 3K FLT | PCM2 | N-TO-G | o | t |
| | dB | C-MSG | T1R1 | BAL | - | - |
| | dB | S/N | TR | | | |

Description --- Three leading blanks, followed by a signed level measurement, the relative zero label, the filter type, the signal source label, and the type of measurement.

RETURN LOSS:

4-WIRE:

| | | | | | |
|---------------|---------------------|----------------|----------------|----------|----------|
| +NNNdB | SRL LO NNNHz | +NN THL | 4W 1200 | O | T |
| | SRL HI | | 4W 900 | o | t |
| | ERL | | 4W 600 | - | - |
| | OSC | | PCM1 | | |
| | | | PCM2 | | |

Description --- Two leading blanks, followed by a signed level measurement and the label "dB", the signal type, the frequency of the echo suppress tone or the oscillator tone and the label "Hz", a signed trans-hybrid loss level and the label "THL", and a trunk type label.

2-WIRE: -- NORMAL:

| | | | | |
|---------------|---------------------|----------------|----------|----------|
| +NNNdB | SRL LO NNNHz | 2W 1200 | O | T |
| | SRL HI | 2W 900 | o | t |
| | ERL | 2W 600 | - | - |
| | OSC | 2W 150 | | |

Description --- Two leading blanks, followed by a signed level measurement and the label "dB ", the signal type, the frequency of the echo suppress tone or oscillator tone and the label "Hz", ten blanks, and a trunk type label.

2-WIRE: -- TR TERM:

| | | | |
|----------------|--------------------|----------|----------|
| TR TERM | AC SHORT 2W | O | T |
| | AC OPEN | o | t |
| | 900+2.16 | - | - |
| | 600+2.16 | | |

Description --- 9 leading blanks, followed by the label "TR TERM" and an additional 8 blanks, a circuit descriptor label, and the "2W" descriptor with 9 trailing blanks.

In the previous examples of typical CRT displays, numbers were denoted by a single "N" for each possible digit. The understanding was that this "N" was showing location, rather than numerical value. In fact, each "N" could stand for any number. If a decimal point were present, it was shown as a "." . Signed numbers were shown being preceded by a "+" character. In practice, this could be either a "+" or "-".

Leading zeros will be printed as blanks and trailing zeros will be printed as zeros. The digit to the left of the decimal point will always be printed, even if it is a leading zero. The sign of the number will always be printed to the left of the first non-blank digit.

For example, a number which was represented by "+NN.N" could be any of the following in practice:

+99.9, -1.0, +0.0, -0.4, +7.4

6-4.6 PROGRAMMERS NOTES

6-4.6.1 INITIALIZING THE 930A

Send the command string **"AAA"** when you first access the 930A remotely. This ensures that you have exited from any tests or sub-menus the 930A may have been left in. You may use any of the Function key commands (A,B,C,D,E,F or G), but three repetitions is the minimum necessary to bring the 930A to a known state before testing. By sending **"AAA"** you take the 930A to the Trunk Type menu, no matter where it was previously. Sending **"GGG"** would take the 930A to the Option Menu instead.

After this initial string has been sent, you should probably send a Trunk Type initialization string, to ensure that the 930A is properly terminated or bridged, looking at the correct signaling leads, etc. Use the **HELP** menu in Trunk Type to accomplish this (see the following pages for details). Two examples would be:

```
NORMALLOOP TERM CONTACT 2W 900: "A?J;;LKK"  
E&M TYPE II TERM SEND-E 4W 600: "A?L2JK;K;"
```

It is a good idea to append a lowercase "o" to your initialization string, to ensure that the 930A is On-Hook.

To ensure that the 930A is in quiet termination (sending no tone), you should send a Send Tone initialization string, such as "D?;1004J160J." This sets the frequency to 1004 Hz, the level to -16.0 dBm, and the output to **OFF**.

Note: in the example above, the numeric input for frequency and level were terminated by the "J" character. Numeric input may be terminated by a carriage return or any softkey (J, K, L or ;). Since the carriage return is difficult to display, the "J" character has been used in all the examples contained in this document.

You may now use the 930A to send or receive calls, send and measure tones and other VF signals, and perform automated tests to remote test lines and responders. The following section on **HELP** menus will get you started. There are separate sections on placing multistage calls, using the digit receiver/analyzer, and placing calls to remote test lines and responders.

If the 930As available to you do not all have the same software revision, or

have different options installed, the tests available or the method of performing such tests may vary. Sage Instruments will upgrade your company's instruments to the current software revision at no charge. It will make your task simpler if your company orders all 930As with the same set of options. If this is not possible, make use of Menu Options 91 (**Software Version**) and 94 (**List Options**) to determine the software revision and installed options.

For the convenience of programmers the 930A can be commanded remotely to dump its buffers and restore itself to the factory defaults. This allows the programmer to write software starting at a known configuration every time. Menu Option 92: SOFTWARE COLD-BOOT is used for this purpose. Simply begin the program by getting to the Option Menu function, enter the number 92, send a Return and then send a 'K'. The sequence looks like:

"GGG92|K"

This command does not affect the RS-232 remote port settings nor does it affect the time/date settings. **NOTE:** A hardware cold-boot (described in Section 3) will restore the RS-232 port settings to their factory default values.

6-4.6.2 USING THE HELP MENUS

Pressing the **HELP** key on the 930A brings up a series of menus for the user. The menu presented will depend on the function the 930A is executing. Transmitting the ASCII "?" character remotely has the same effect as pressing the **HELP** key.

Many of the 930A's features are controlled using softkeys (the four unlabeled keys directly beneath the display).

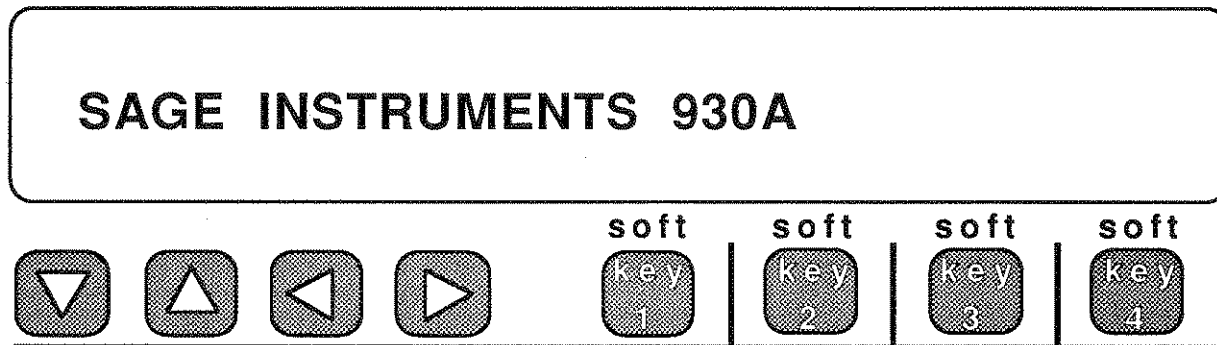

These softkeys often take the place of thumbwheels or on/off toggles. The current setting is usually displayed above the softkey (for example, in **MEASURE NOISE**, the display over Softkey 2 shows either "**C-NOTCH**", "**C-MSG**", "**3K FLAT**", or "**S/N**"). If the display shows what you want, you do nothing: the setting is already correct. Otherwise, press the softkey until the display shows the setting you want.

This is fairly simple for you or I, but for a computer it presents problems. Just "looking" to see that the display shows the desired setting is a nuisance. Going into a loop that presses the softkey, looks at the display, and repeats until it's correct is a major annoyance.

Using the **HELP** menus allows the computer to avoid this procedure. When it wants the C-Notch filter, the computer sends a short character string that always selects C-Notch, regardless of the previous state.

Once you have used a **HELP** menu to put the 930A in a known state, it may be more efficient to use the softkeys in the usual way. You would always use the **HELP** menus when your program begins: this provides a simple and foolproof initialization. After using a **HELP** menu once to put the 930A in a known state, you may continue to use the **HELP** menus throughout your program or pursue greater efficiency by using the softkeys. The difference is typically only a few extra characters and a few hundred milliseconds, and the choice is really a matter of programming style.

The following section gives a brief overview of the **HELP** menus and includes some sample command strings.

TRUNK TYPE (Analog circuits)

| Trunk Type | Help | Type/Sense | Direction | Bridge/Term |
|--------------------|---------------|-------------------|------------------------|--------------------|
| Ohms | | 2W/4W | | |
| Trunk Type | A =Trunk Type | | | |
| Help | ? =Help | | | |
| Type | J =Loop | K = Ground-Start | L{1-5}J = E&M Type I-5 | |
| Sense* | K = Normal | ; = Reverse | | |
| Direction | K =Battery | ; = Contact | K=SEND-E | ; = SEND-M |
| Bridge/Term | K =Bridge | ; = Terminate | | |
| Ohms | J =150 | K = 600 | L = 900 | ; = 1200 |
| 2W/4W | K =2 Wire | ; = 4 Wire | | |

* (Loop and Gnd-Start only)

Examples:

| | | | |
|--------------------|--------------|--------|-------------|
| E&M Type I | TERM SEND-E | 4W 600 | "A?L1JK;K;" |
| E&M Type II | TERM SEND-M | 2W 900 | "A?L2J;;LK" |
| LOOPNORMAL | TERM CONTACT | 2W 900 | "A?JK;;LK" |
| Toggle Bridge/Term | | | "K" |
| Toggle Direction | | | "L" |

DIAL/RING

| Dial/Ring | Help | Pulsing | Digits |
|-----------|--|---------|----------|
| Dial/Ring | B =Dial/Ring | | |
| Help | ? =Help | | |
| Pulsing | K=Dial Pulse | L = MF | ; = DTMF |
| Digits | Up to 17 digits | | |
| | All pulsing types: 0-9, "-" for 1 sec. pause | | |
| | DTMF: a,b,c,d,*,# | | |
| | MF: *=KP, #=ST, a=STP, b=ST2P, c=ST3P | | |

If you are already Off-Hook, the digits will be sent immediately. If you are On-Hook, the digits will be stored in **DIAL/RING**. Go off hook and send ASCII **"K"** to send stored digits.

Sending an ASCII blank " " clears any existing digits. Using the **HELP** key also clears any previous digits.

Examples:

Go to **DIAL/RING**. Go off hook. Select DTMF. Dial (408) 761-1000:
"BO?;4087611000"

Go to **DIAL/RING**. Go on hook. Select MF. Store KP007ST to be dialed later:
"Bo?L*007#"

Go to **DIAL/RING**. Go off hook. Select Dial Pulse. Pause 1 second and dial 9:
"BO?K-9"

Go to **DIAL/RING**. Go off hook and send the most recently entered digit string:
"BOK"

Go to **DIAL/RING**, clear any old digits, and dial "411" in the current pulse mode:
"B 411"

RETURN LOSS

4 Wire:

Return Loss **Help** **Band** **Frequency** **Acknowledge** **Set THL**

Return Loss C =Return Loss

Help? = Help

Band J =SRL-LO K = SRL-HI L = ERL ; = OSC (sine wave)

Frequency nnnnJ = freq. of nnnn Hz for echo suppress tone and/or sine wave
Return Loss

Acknowledge J,K,L or ; acknowledges message

Set THL L = Current measurement is THL ;nnJ = THL is -nn dB

2 Wire:

Return Loss **Help** **Mode** [**Band** **Frequency**] or [**Termination**]

Return Loss C =Return Loss

Help? = Help

Mode K =Return Loss ; = TR Termination

Return Loss:

Band J =SRL-LO K = SRL-HI L = ERL ; = OSC (sine wave)

Frequency nnnnJ = freq. of nnnn Hz for echo suppress tone and/or sine wave

TR Termination:

Termination: J=AC Short K=600 +2.14 F L=900 +2.14 F ;=AC Open

Examples:

4W:

Go to Return Loss. Select ERL, 2225 Hz Echo Suppress, no THL compensation:

"C?L2225JJ0J"

Go to Return Loss. Select SRL-LO, 2225 Hz Echo Suppress, measure THL:

"C?J2225JJK"

2W:

Go to Return Loss. Select SRL-LO, 2225 Hz Echo Suppress tone:

"C?KJ2225J"

Go to Return Loss. Select 900 with 2.14 F quiet termination:

"C?;L"

All types:

Send echo suppress tone: "K"

SEND TONE

| Send Tone | Help | Output | Frequency | Level |
|-----------|--|--------|-----------|-------|
| Send Tone | D = Send Tone | | | |
| Help | ? = Help | | | |
| Output | K = ON ; = OFF | | | |
| Frequency | nnnnJ = frequency of nnnn Hz | | | |
| Level | nnnJ = level of -nn.n dBm (for level of +nn.n dBm, send "nnndJ") | | | |

Examples:

Send 1004 Hz at 0.0 dBm "D?K1004J0J"

Send 1004 Hz at -16.0 dBm "D?K1004J160J"

Send 2804 Hz at -13.0 dBm "D?K2804J130J"

Send 404 Hz at +3.2 dBm "D?K0404J32dJ"

Set freq. and level to 104 Hz at -10.0 dBm: do not send tone:
"D?;0104J100J"

Toggle tone on/off "D;"

Set freq. to 1010 Hz "DJ1010J"

Set level to -16.0 dBm "DK160J"

MEASURE TONE

Measure Tone Help Reference Mode*

Measure Tone E = Measure Tone

Help ? = Help

Reference K = Absolute (dBm) L = Set 0 (dB relative to current level)
;nnnJ = dBm0 (dB relative to -nn.n dBm)

Mode* K = Average¹ ; = RMS²

* Software Rev. 3.17 and later

¹ Use **Average** to measure sine waves

² Use **RMS** to measure the level of non-sinewave tones and digital milliwatt

Examples:

Measure in dBm: "E?KK"

Make future measurements in dB relative to -16.0 dBm: "E?;160JK"

Make future measurements in dB relative to current measured level: "E?LK"

Make RMS measurements in dBm: "E?K;"

Toggle RMS/Average: "L"

Measure tone: "E" "Z" (Wait 1 sec. between sending "E" and "Z")
or "EZZ" (Disregard first measurement)

Note: If a tone has been selected in **SEND TONE**, and the output is **ON**, the tone will also be sent in **MEASURE TONE**. To measure far-to-near tone on a 2-Wire circuit, be sure **SEND TONE**'s output is set to **"OFF"**.

MEASURE NOISE

| Measure Noise | Help | Filter | Mode* | Reference |
|---------------|---------------------|---------------------------|--|--|
| Measure Noise | F = Measure Noise | | | |
| Help | ? = Help | | | |
| Filter | J = 3 KHz flat | K = C-Message L = C-Notch | | ; = Signal/Noise |
| Mode* † | K = Balanced | | | ; = Noise-to-ground |
| Reference † | K = Absolute (dBrn) | | L = Set 0 (dB relative to current level) | |
| | | | | ;nnndJ = dBrn0 (dB relative to nnn dBrn) |

* Not available in PCM. In PCM, the 930A measures channel noise only.

† Not available when making signal/noise measurement.

Examples:

Measure balanced noise in dBrnC using the C-Notch filter: **"F?LKK"**

Measure signal/noise: **"F?;"**

Measure noise-to-ground relative to 90 dBrn using the 3 KHz flat filter:
"F?J;090dJ"

Measure noise: **"F" "Z"** (Wait 1 sec. between sending "F" and "Z")
or **"FZZ"** (Disregard first measurement)

Note: If a tone has been selected in **SEND TONE**, and the output is **ON**, the tone will also be sent in **MEASURE NOISE**. To measure far-to-near noise on a 2-wire circuit, be sure **SEND TONE**'s output is set to **"OFF"**.

6-4.6.3 WHEN DOES THE 930A SEND A BELL?

The 930A can be set to wait for or detect a variety of events. The 930A sends the bell character to let the remote operator or computer program know that such an event has occurred. Some events are reported only if the user selects them. Others are reported only if the 930A is performing a certain function. You can select the events which will be reported from Menu Option 34: SELECT REPORTS. This allows reporting to be turned ON or OFF for PCM Errors, Received Calls, or Wink Timing. The bell is sent only in Computer Remote mode. The following lists the events and conditions for a bell to be sent.

| <u>EVENT</u> | <u>REPORTED WHEN 930A IN:</u> |
|---|---|
| PCM ERROR --An error on the T1 span such as a slip, bipolar violation, remote alarm, etc. has been detected. | PCM Trunk Type. REPORT PCM ERRORS selected. |
| INCOMING CALL COMPLETE --The 930A has received a call. | Option Menu 4: Digit Receiver REPORT RECEIVED RECORDS selected. |
| WINK TIMING AVAILABLE --A call has completed or abandoned, and a wink, off-hook, delay dial event, dial-tone or credit card "bong" was expected. | Option Menu 2: Send Digit Sequences Option Menu 4: Digit Receiver REPORT WINK TIMING selected. |
| WINK FAILURE --An expected wink, off-hook, delay dial event, dialtone or "bong" failed to appear or was not recognizable. | Option Menu 2: Send Digit Sequences Option Menu 4: Digit Receiver |
| SIGNALING BIT CHANGE --An A, B, C, or D bit has changed state on one of the 24 PCM Channels. | PCM Trunk Type Option Menu 20: 24 Bit Display |
| RINGING OR LINE SEIZURE --The 930A detects ringing or seizure and goes off-hook. | Option Menu 32: Dial-Up Testline Option Menu 33: Dial-Up Sweep |

EVENT

REPORTED WHEN 930A IN:

IMPULSE or HIT--An Impulse, gain hit, phase hit or dropout has occurred.

CALL PROGRESS FAILURE--The 930A detects Busy, Reorder, Dead Line or any other call progress failure when it attempts to access a test line.

TEST DATA AVAILABLE--A test to a far end test line has completed, or has a screen full of results available. LOSS has one screen of data (one bell), GAIN SLOPE has three screens of data (one bell each), etc.

Option Menu 11: Impulse and Hits

Calling to a test line from:
Option Menu 2: Send Digit Sequences

Option Menu 26: ROTL/Responder

Option Menu 27: ROTL

Interrogator

Option Menu 28: Transponder Test

Option Menu 29: Call 102 Line

Calling to a test line from:

Option Menu 2: Send Digit Sequences

Option Menu 26: ROTL/Responder

Option Menu 27: ROTL

Interrogator

Option Menu 28: Transponder Test

Option Menu 29: Call 102 Line

