

ThunderBolt™ GPS Disciplined Clock User Guide

Version 5.0

Part Number: 35326-30

November 2003

*Trimble Navigation Limited
Component Technologies
645 North Mary Avenue
Post Office Box 3642
Sunnyvale, CA 94088-3642
U.S.A.*

*+1-800-827-8000 in North America
+1-408-481-8000 International
FAX: +1-408-481-2011*

U.S. Technical Assistance and Repair

+1-800--SOS-4-TAC in North America
+1-408-481-6940 International
FAX: +1-408-481-6020

European Technical Assistance and Repair

+44(0)1256 746207

Copyrights

© 2002-2003 Trimble Navigation Limited. All rights reserved. No part of this manual may be copied, photocopied, reproduced, translated, or reduced to any electronic medium or machine-readable form without prior written consent from Trimble Navigation Limited.

Printed in the United States of America. Printed on recycled paper.

Revision Notice

This is the fifth release of the *ThunderBolt GPS Disciplined Clock Manual*, Part Number 35326-30, November 2003.

Trademarks

ACE GPS, SVeeSix, SVeeSix-CM3, Lassen-SK8, Acutis, Acutime, AcutimeII, ThunderBolt, and TSIP are trademarks of Trimble Navigation Limited. IBM is a registered trademark of International Business Machines, Inc. MS-DOS and Windows is a trademark of Microsoft Corporation. Intel is a trademark of Intel Corporation. All other brand names are trademarks of their respective holders.

Disclaimer of Warranty

EXCEPT AS INDICATED IN "LIMITED WARRANTY" HEREIN, TRIMBLE HARDWARE, SOFTWARE, FIRMWARE AND DOCUMENTATION IS PROVIDED "AS IS" AND WITHOUT EXPRESS OR LIMITED WARRANTY OF ANY KIND BY EITHER TRIMBLE OR ANYONE WHO HAS BEEN INVOLVED IN ITS CREATION, PRODUCTION, OR DISTRIBUTION INCLUDING BUT NOT LIMITED TO THE IMPLIED WARRANTIES OF MERCHANTABILITY AND FITNESS FOR A PARTICULAR PURPOSE. THE ENTIRE RISK, AS TO THE QUALITY AND PERFORMANCE OF THE TRIMBLE HARDWARE, SOFTWARE, FIRMWARE AND DOCUMENTATION, IS WITH YOU. SOME STATES DO NOT ALLOW THE EXCLUSION OF IMPLIED WARRANTIES, SO THE ABOVE EXCLUSION MAY NOT APPLY TO YOU.

Limitation of Liability

IN NO EVENT WILL TRIMBLE OR ANY PERSON INVOLVED IN THE CREATION, PRODUCTION, OR DISTRIBUTION OF THE TRIMBLE PRODUCT BE LIABLE TO YOU ON ACCOUNT OF ANY CLAIM FOR ANY DAMAGES, INCLUDING ANY LOST PROFITS, LOST SAVINGS, OR OTHER SPECIAL, INCIDENTAL, CONSEQUENTIAL, OR EXEMPLARY DAMAGES, INCLUDING BUT NOT LIMITED TO ANY DAMAGES ASSESSED AGAINST OR PAID BY YOU TO ANY THIRD PARTY, ARISING OUT OF THE USE, LIABILITY TO USE, QUALITY OR PERFORMANCE OF SUCH TRIMBLE PRODUCT INCLUDING HARDWARE, SOFTWARE, FIRMWARE, AND DOCUMENTATION, EVEN IF TRIMBLE OR ANY SUCH PERSON OR ENTITY HAS BEEN ADVISED OF THE POSSIBILITY OF DAMAGES, OR FOR ANY CLAIM BY ANY OTHER PARTY. SOME STATES DO NOT ALLOW THE LIMITATION OR EXCLUSION OF LIABILITY FOR INCIDENTAL OR CONSEQUENTIAL DAMAGES SO, THE ABOVE LIMITATIONS MAY NOT APPLY TO YOU.

Software and Firmware Limited Warranty

Trimble warrants that Software and Firmware products will substantially conform to the published specifications provided it is used with the Trimble products, computer products, and operating system for which it was designed. For a period of ninety (90) days, commencing thirty (30) days after shipment from Trimble, Trimble also warrants that the magnetic media on which Software and Firmware are distributed and the documentation are free from defects in materials and workmanship. During the ninety (90) day warranty period, Trimble will replace defective media or documentation, or correct substantial program errors at no charge. If Trimble is unable to replace defective media or documentation, or correct program errors, Trimble will refund the price paid for The Software. These are your sole remedies for any breach in warranty.

Hardware Limited Warranty

Trimble Navigation Limited products are warranted against defects in material and workmanship for a period of one year. The warranty period shall commence thirty (30) days after shipment from Trimble's factory. Warranty service will be provided at a designated Trimble Service Center. Trimble will at its option either repair or replace products that prove to be defective. The Customer shall pay all shipping charges for products returned to Trimble for warranty service. Trimble shall pay all shipping charges for the return of products to the Customer.

This warranty shall not apply to defects resulting from one or more of the following:

- Improper or inadequate maintenance by the buyer
- Buyer-supplied software or interfacing
- Unauthorized modification or misuse
- Operation outside of the environmental specifications of the product
- Improper installation, where applicable
- Lightning or other electrical discharge
- Fresh or salt water immersion or spray
- Normal wear and tear on consumable parts (for example, batteries)

No other warranty is expressed or implied. Trimble Navigation Limited specifically disclaims the implied warranties of fitness for a particular purpose and merchantability.

Contents

Preface

Manual Overview	xvii
Technical Assistance	xviii
Your Comments.	xviii
Document Conventions.	xviii
Notes, Tips, Cautions, and Warnings.	xix

1 Introduction

1.1 ThunderBolt Overview	1-1
1.2 Starter Kit.	1-2
1.2.1 Antennas	1-2
1.2.2 Cable.	1-2
1.3 The Global Positioning System.	1-3

2 Getting Started

2.1 ThunderBolt Setup	2-1
2.1.1 Connecting the ThunderBolt	2-1
2.1.2 Antenna Mounting.	2-1
2.1.3 Antenna Cable	2-3
2.1.4 Terminating the Antenna with the "F" Connector.	2-3
2.1.5 Preparing Cable for Termination	2-4
2.1.6 Power	2-6
2.1.7 Computer Connection	2-6
2.2 Software Interface	2-6
2.2.1 ThunderBolt Monitor Program	2-7
2.2.2 TSIPCHAT.	2-7
2.2.3 TSIP	2-8
2.3 Basic Features	2-8
2.3.1 Cable Delay Compensation	2-8
2.3.2 Timing Information	2-8
2.3.3 Elevation Mask	2-9
2.3.4 Signal Level Mask.	2-9

2.3.5	Reference Position	2-9
2.4	Maintenance	2-10
3	Hardware Integration	
3.1	ThunderBolt GPS Disciplined Clock.	3-1
3.2	Power Connector Pin-Out and Part Numbers	3-4
3.3	Interface Connector Pin-Out Table	3-4
3.4	Antenna Cables	3-5
3.4.1	Routing/Securing Cable	3-7
3.5	Power Supply and Connector.	3-7
3.6	Bullet Antenna Specifications	3-8
4	Software Interface	
4.1	Firmware Configuration	4-1
4.2	Firmware Upgrades.	4-1
4.3	Firmware Features	4-2
4.4	Windows Control Program	4-2
5	Operations	
5.1	General GPS Description.	5-1
5.1.1	Oscillator Disciplining Basics	5-1
5.1.2	Kalman Filtering.	5-4
5.1.3	Oscillator Performance	5-4
5.2	Timing Between Sites	5-8
5.3	GPS Timing.	5-8
5.3.1	Timing Operation	5-9
5.3.2	System Architecture	5-12
A	Trimble Standard Interface Protocol for ThunderBolt	
A.1	Interface Scope	A-1
A.2	Automatic Output Packets	A-2
A.3	Customizing ThunderBolt Operations	A-3
A.4	Packets Output at Power-Up	A-6
A.5	Changes to ThunderBolt Firmware.	A-6
A.6	Report Packets: ThunderBolt to User	A-7
A.7	Command Packets: User to ThunderBolt.	A-8
A.8	Packet Structure	A-9
A.9	Packet Descriptions.	A-10
A.9.1	Command Packet 0x1E Initiate Cold or Factory Reset	A-10

A.9.2	Command Packet 0x1F Request Software Version	A-10
A.9.3	Command Packet 0x20 Request Almanac.	A-10
A.9.4	Command Packet 0x24 Request GPS Satellite Selection List.	A-10
A.9.5	Command Packet 0x25 Initiate Warm Reset & Self Test	A-11
A.9.6	Command Packet 0x27 - Request Signal Levels	A-11
A.9.7	Command Packet 0x29 - Request Almanac Health Page	A-11
A.9.8	Command Packet 0x31 Set Accurate Initial Position (XYZ Cartesian ECEF)	A-11
A.9.9	Command Packet 0x32 Set Accurate Initial Position (Latitude, Longitude, Altitude)	A-12
A.9.10	Command Packet 0x34 – Set Satellite Selection For One-Satellite Mode	A-12
A.9.11	Command Packet 0x35 Set or Request I/O Options.	A-12
A.9.12	Command Packet 0x37 Request Status and Values of Last Position	A-13
A.9.13	Command Packet 0x38 Request Satellite System Data	A-14
A.9.14	Command Packet 0x39 Set or Request SV Disable and Health Use	A-14
A.9.15	Command Packet 0x3A Request Last Raw Measurement	A-15
A.9.16	Command Packet 0x3B Request Current Status of Ephemeris Data	A-15
A.9.17	Command Packet 0x3C Request Current Satellite Tracking Status.	A-15
A.9.18	Command Packet 0x3F-11 Request EEPROM Segment Status.	A-15
A.9.19	Report Packet 0x42 Single-precision Position Fix	A-16
A.9.20	Report Packet 0x43 Velocity Fix, XYZ ECEF	A-16
A.9.21	Report Packet 0x45 Software Version Information	A-17
A.9.22	Report Packet 0x47 Signal Level for All Satellites Tracked	A-17
A.9.23	Report Packet 0x49 - Almanac Health Page.	A-18
A.9.24	Report Packet 0x4A Single Precision LLA Position Fix	A-18
A.9.25	Report Packet 0x55 I/O Options.	A-19
A.9.26	Report Packet 0x56 Velocity Fix, East-North-Up (ENU)	A-20
A.9.27	Report Packet 0x57 Information about Last Computed Fix.	A-20
A.9.28	Report Packet 0x58 GPS System Data from Receiver	A-21
A.9.29	Report Packet 0x59 Status of Satellite Disable or Ignore Health	A-24
A.9.30	Report Packet 0x5A Raw Measurement Data	A-25
A.9.31	Report Packet 0x5B Satellite Ephemeris Status.	A-25
A.9.32	Report Packet 0x5C Satellite Tracking Status.	A-26
A.9.33	Report Packet 0x5F-11 EEPROM Segment Status	A-28
A.9.34	Report Packet 0x6D Satellite Selection List.	A-29
A.9.35	Command Packet 0x70 Filter Configuration	A-29
A.9.36	Report Packet 0x70 Filter Configuration	A-30
A.9.37	Report Packet 0x83 Double Precision XYZ ECEF Position Fix	A-31
A.9.38	Report Packet 0x84 Double Precision LLA Position Fix	A-31
A.9.39	Command Packet 0xBB Request or Set GPS Receiver Configuration	A-32

A.9.40	Command Packet 0xBC Set or Request Serial Port Configuration	A-33
A.10	TSIP Superpackets	A-35
A.10.1	Command Packet 0x8E-41 Request Manufacturing Parameters	A-35
A.10.2	Command Packet 0x8E-42 Request Production Parameters	A-35
A.10.3	Command Packet 0x8E-45 Revert Segments to Default Settings	A-35
A.10.4	Command Packet 0x8E-4A Set or Request PPS Characteristics	A-36
A.10.5	Command Packet 0x8E-4C Save Segments to EEPROM	A-37
A.10.6	Command Packet 0x8E-A0 Set DAC Value	A-37
A.10.7	Command Packet 0x8E-A1 10 MHz Output Sense	A-38
A.10.8	Command Packet 0x8E-A2 UTC/GPS Timing	A-38
A.10.9	Command Packet 0x8E-A3 Issue Disciplining Command	A-39
A.10.10	Command Packet 0x8E-A4 Test Modes	A-39
A.10.11	Command Packet 0x8E-A5 Set or Request Packet Broadcast Mask	A-41
A.10.12	Command Packet 0x8E-A6 Issue Self-Survey Command	A-42
A.10.13	Command Packet 0x8E-A8 Set or Request Disciplining Parameters	A-42
A.10.14	Command Packet 0x8E-A9 Set or Request Self-Survey Parameters	A-45
A.10.15	Command Packet 0x8E-AB Request Primary Timing Packet	A-46
A.10.16	Command Packet 0x8E-AC Request Supplemental Timing Packet	A-46
A.10.17	Report Packet 0x8F-41 Stored Manufacturing Operating Parameters	A-47
A.10.18	Report Packet 0x8F-42 Stored Production Parameters	A-48
A.10.19	Report Packet 0x8F-4A PPS Characteristics	A-48
A.10.20	Report Packet 0x8F-45 Revert Segments to Factory Defaults	A-49
A.10.21	Report Packet 0x8F-4C Save Segments to EEPROM	A-49
A.10.22	Report Packet 0x8F-A0 DAC Value	A-50
A.10.23	Report Packet 0x8F-A1 10 MHz Sense	A-51
A.10.24	Report Packet 0x8F-A2 UTC/GPS Timing Mode	A-51
A.10.25	Report Packet 0x8F-A4 Test Modes	A-52
A.10.26	Report Packet 0x8F-A5 Packet Broadcast Mask	A-53
A.10.27	Report Packet 0x8F-A7 Individual Satellite Solutions	A-53
A.10.28	Report Packet 0x8F-A8 Disciplining Parameters	A-55
A.10.29	Report Packet 0x8F-A9 Self-Survey Parameters	A-56
A.10.30	Report Packet 0x8F-AB Primary Timing Packet	A-56
A.10.31	Report Packet 0x8F-AC Supplemental Timing Packet	A-59
A.11	Reference Documents	A-63

B TSIP User's Guide

B.1	TSIP Terms/Definitions	B-1
-----	----------------------------------	-----

C Specifications and Drawings

C.1 Drawing C-1

C.2 Specifications C-2

 C.2.1 Performance Specifications: C-2

 C.2.2 Environmental Specifications: C-2

 C.2.3 Interface Specifications: C-2

 C.2.4 Physical Characteristics: C-3

Glossary

Index

List of Figures

Figure 2-1	Mounting the Bullet Antenna	2-2
Figure 2-2	Satellite Density	2-3
Figure 2-3	Expose the Center Conductor	2-4
Figure 2-4	Cutting the Cable Jacket	2-5
Figure 2-5	Fold Back the Shield	2-5
Figure 2-6	ThunderBolt Monitor Program	2-7
Figure 3-1	ThunderBolt Clock Components	3-1
Figure 3-2	ThunderBolt Clock Module Dimensions	3-2
Figure 3-3	ThunderBolt Board-Only Mechanical Drawing	3-3
Figure 3-4	RG-59: Loss vs. Length	3-6
Figure 3-5	RG-8: Loss vs. Length	3-6
Figure 5-1	ThunderBolt Disciplining State Diagram	5-2
Figure 5-2	White Noise	5-5
Figure 5-3	Random Walk.	5-5
Figure 5-4	Allan Variance	5-6
Figure 5-5	Allan Variances with GPS	5-7
Figure 5-6	PPS with rising edge	5-10
Figure 5-7	PPS with falling edge.	5-10
Figure 5-8	10 MHz with positive zero crossing (shown with rising edge).	5-11
Figure 5-9	10 MHz with negative zero crossing (shown with rising edge)	5-11
Figure 5-10	ThunderBolt System Architecture	5-12
Figure C-1	ThunderBolt GPS Disciplined Clock dimensions	C-1

List of Tables

Table 3-1	Power Connector Pin-outs	3-4
Table 3-2	Power Specifications (Board-only).	3-4
Table 3-4	RG-59 Cable Specifications	3-5
Table 3-3	Serial Data Connector Pin-outs: ThunderBolt Module.	3-5
Table 3-5	Power Supply Mating Connector (AMP Part Numbers)	3-7
Table 3-6	Physical Characteristics	3-8
Table 3-7	Environmental Specifications	3-8
Table 5-1	GPS Error Sources	5-8
Table A-1	Automatic Output Packets	A-2
Table A-2	Receiver Configuration - Segment 3	A-3
Table A-4	Serial Port Configuration - Segment 5	A-4
Table A-5	Timing Outputs - Segment 6	A-4
Table A-6	Accurate Position - Segment 7	A-4
Table A-3	Packet I/O Control - Segment 4	A-4
Table A-7	Self-Survey - Segment 8	A-5
Table A-8	Oscillator Disciplining - Segment 9	A-5
Table A-9	Packets Output at Power-up	A-6
Table A-10	Obsolete Packets	A-6
Table A-11	Report Packets	A-7
Table A-12	Command Packets	A-8
Table A-13	Command Packet 0x1E Data Format.	A-10
Table A-14	Command Packet 0x31 Data Format <<segment 7>>	A-11
Table A-15	Command Packet 0x32 Data Format <<segment 7>>	A-12
Table A-16	Command Packet 0x35 Date Format << segment 3>>.	A-13
Table A-17	Command Packet 0x38 Data Format.	A-14
Table A-18	Command Packet 0x39 Data Format.	A-14
Table A-19	Command Packet 0x3A Data Format	A-15
Table A-20	Command Packet 0x3C Data Format	A-15
Table A-21	Report Packet 0x42 Data Format.	A-16
Table A-22	Report Packet 0x43 Data Format.	A-16
Table A-23	Report Packet 0x45 Data Format.	A-17
Table A-24	Report Packet 0x47 Data Format.	A-17

List of Tables

Table A-25	Report Packet 0x49 Data Format.	A-18
Table A-26	Report Packet 0x4A Single Precision LLA Position Fix.	A-18
Table A-27	Report Packet 0x55 Date Format << segment 3>>	A-19
Table A-28	Report Packet 0x56 Data Format.	A-20
Table A-29	Report Packet 0x57 Data Format.	A-20
Table A-30	Report Packet 0x58 Data Format.	A-21
Table A-31	Report Packet 0x58 Data Format.	A-21
Table A-32	Report Packet 0x58 Almanac Health Data (Type 3)	A-22
Table A-33	Report Packet 0x58 Ionosphere Data (Type 4).	A-22
Table A-34	Report Packet 0x58 UTC Data (Type 5)	A-23
Table A-35	Report Packet 0x58 Ephemeris Data (Type 6)	A-23
Table A-36	Report Packet 0x59 Data Format.	A-24
Table A-37	Report Packet 0x5A Data Format	A-25
Table A-38	Report Packet 0x5B Data Format	A-25
Table A-39	Report Packet 0x5C Data Format	A-26
Table A-40	Report Packet 0x5F-11 Data Format	A-28
Table A-41	Report Packet 0x6D Data Format	A-29
Table A-42	Command Packet 0x70 Data Format.	A-30
Table A-43	Report Packet 0x70 Data Format.	A-30
Table A-44	Report Packet 0x83 Data Format.	A-31
Table A-45	Report Packet 0x84 Data Format.	A-31
Table A-46	Command Packet 0xBB Data Format (to request)	A-32
Table A-47	Command and Report Packet 0xBB Data Format	A-32
Table A-48	Command Packet 0xBC Data Format (request)	A-33
Table A-49	Command and Report Packet 0xBC Field Data Format	A-34
Table A-50	Command Packet 0x8E-45 Data Format	A-35
Table A-51	Command Packet 0x8E-4A Data Format <<segment 6>>.	A-36
Table A-52	Command Packet 0x8E-4C Data Format.	A-37
Table A-54	Command Packet 0x8E-A1 Data Format <<segment 6>>.	A-38
Table A-53	Command Packet 0x8E-A0 Data Format	A-38
Table A-56	Command Packet 0x8E-A3 Data Format	A-39
Table A-55	Command Packet 0x8E-A2 Data Format <<segment 6>>.	A-39
Table A-57	0x8E-A4 Test Mode 0 Data Format	A-40
Table A-59	0x8E-A4 Test Mode 3 Data Format	A-41
Table A-58	0x8E-A4 Test 1 Mode 1 Data Format	A-41
Table A-61	Command Packet 0x8E-A6 Data Format	A-42
Table A-60	Command Packet 0x8E-A5 Data Format <<segment 4>>.	A-42
Table A-62	Command Packet 0x8E-A8 Type 0 Data Format <<segment 9>>.	A-43
Table A-63	Command Packet 0x8E-A8 Type 1 Date Format <<segment 9>>.	A-44

Table A-64	Command Packet 0x8E-A8 Type 2 Date Format <<segment 9>>.	A-44
Table A-65	Command Packet 0x8E-A8 Type 3 Date Format <<segment 9>>.	A-44
Table A-66	Command Packet 8E-A9 Data Format <<segment 8>>.	A-45
Table A-67	Command Packet 0x8E-AB Data Format	A-46
Table A-69	Stored Manufacturing Operating Parameters.	A-47
Table A-68	Command Packet 0x8E-AC Data Format	A-47
Table A-70	Stored Production Parameter.	A-48
Table A-71	Set PPS Characteristics.	A-48
Table A-72	Save Segments to EEPROM	A-49
Table A-73	Save Segments to EEPROM	A-49
Table A-74	Report Packet 0x8F-A0 Data Format	A-50
Table A-75	Report Packet 0x8F-A1 Description <<segment 6>>.	A-51
Table A-76	Report Packet 0x8F-A2 Data Format <<segment 6>>.	A-51
Table A-77	0x8F-A4 Exit Test Mode 0 Data Format.	A-52
Table A-78	0x8F-A4 Test 1 Mode 1 Data Format	A-52
Table A-79	0x8F-A4 Test Mode 3 Data Format	A-52
Table A-80	Report Packet 0x8F-A5 Data Format <<segment 4>>.	A-53
Table A-82	Report Packet 0x8F-A7 Format 1 Data Format	A-54
Table A-81	Report Packet 0x8F-A7 Format 0 Data Format	A-54
Table A-83	Report Packet 0x8F-A8 Type 0 Data Format	A-55
Table A-84	Report Packet 0x8F-A8 Type 1 Data Format	A-55
Table A-85	Report Packet 0x8F-A8 Type 2 Date Format	A-55
Table A-86	Report Packet 0x8F-A8 Type 3 Date Format	A-55
Table A-87	Report Packet 0x8F-A9 Data Format	A-56
Table A-88	Report Packet 0x8F-AB Data Format	A-58
Table A-89	Report Packet 0x8F-AC Data Format	A-62

Preface

Congratulations on your selection of the ThunderBolt GPS Disciplined Clock.

This manual will answer your questions about the ThunderBolt, whether you are setting up and running a unit for the first time or if you are writing code to use advanced features. Reviewing and understanding the organization of this manual will help you in searching for specific information. Please read this preface before proceeding to other chapters.

As you read through this manual you may find terms which are unfamiliar. For a comprehensive list of terms and definitions, please see the Glossary.

Manual Overview

This manual includes all the information required for integration and operation of the ThunderBolt GPS Disciplined Clock. The manual is organized as follows:

- *Preface*, (this chapter), gives you an overview of the specific information groups in each chapter. It also introduces you to the conventions used throughout the manual.
- Chapter 1, *Introduction*, introduces you to the new ThunderBolt GPS Disciplined Clock and gives you a brief overview. You will find a Starter Kit section that shows you what you need to set up your new unit and a review section of the GPS system.
- Chapter 2, *Getting Started*, describes how to quickly install, connect and operate the ThunderBolt. You will see how to:
 - Set up the ThunderBolt
 - Mount the Bullet Antenna
 - Compensate for Antenna Cable Delay
 - Use the ThunderBolt Monitor Program
 - Determine a Reference Position
 - Use a Basic TSIP Command Set
- Chapter 3, *Hardware Integration*, gives you specific information on Interface Connectors and Cables, Cabling Recommendations for custom sites, the Bullet Antenna, the Power Supply, Pin-out Tables, and Interface Power.
- Chapter 4, *Software Interface*, describes the Firmware Upgrade procedure, Bandwidth Adjustment, Parsing Packets, and Advanced Windows Interfacing.

- Chapter 5, *Operation*, describes the details of the GPS Satellite Message, Timing Accuracy, Differential Performance Characteristics (including loss of signal and reacquisition), Serial Data Communication, GPS Timing, and an overview of the system architecture.
- Appendix A, *Trimble Standard Interface Protocol (TSIP)*, defines the TSIP protocol and the structure of message packets. Custom ThunderBolt commands are included.
- Appendix B, *TSIP User Guide*, describes the TSIP interface programs included with the GPS Tool Kit program CD.



Note – The GPS Tool Kit program CD is included with the Developer's Starter Kit.

- Appendix C, *Specifications and Drawings*, includes the specifications and mechanical drawings for the ThunderBolt board and its associated interface cables.
- The Glossary contains definitions of words and terms used in this manual.
- Index

Technical Assistance

If you have a problem and cannot find the information you need in the product documentation, contact your local distributor. Alternatively, do one of the following:

- Request technical support using the Trimble website at www.trimble.com/support/support.htm
- Send an e-mail to trimble_support@trimble.com.

Your Comments

Your feedback about the supporting documentation helps us to improve it with each revision. E-mail your comments to timing@trimble.com.

Document Conventions

<i>Italics</i>	Software menus, menu commands, dialog boxes and fields.
SMALL CAPITALS	DOS commands, directories, filenames, and filename extensions.
Courier	Represents what is printed on the computer screen.
Courier Bold	Information to be typed in a software screen or window.
[Return] or [Ctrl] + [C]	Identifies a hardware function key or key combination that must be pressed on a computer keyboard.
Helvetica Bold	Represents a software command button.

Notes, Tips, Cautions, and Warnings

Notes, tips, cautions, and warnings are used to emphasize important information.



Note – Notes give additional significant information about the subject to increase your knowledge, or guide your actions. A note can precede or follow the text it references.



Tip – Indicates a shortcut or other time or labor-saving hint that can help you make better use of the product.



Caution – Cautions alert you to situations that could cause hardware damage or software error. A caution precedes the text it references.



Warning – Warnings alert you to situations that could cause personal injury or unrecoverable data loss. A warning precedes the text it references.

1 Introduction

This chapter introduces you to the new ThunderBolt Disciplined GPS Clock and gives you an overview of the unit, the starter kit, and all its content. This chapter also provides a review of the Global Positioning System (GPS).

1.1 ThunderBolt Overview

The ThunderBolt takes GPS disciplined clocks to a higher level. A typical GPS disciplined clock compares the 1 pulse per second (PPS) from a GPS receiver to the 1 PPS derived from an oscillator. This requires a GPS receiver, an oscillator, a microprocessor, and the RAM, ROM, and glue to manage steering of the oscillator. The ThunderBolt provides time and frequency via an 8-channel GPS receiver and a high-quality ovenized quartz oscillator integrated onto a single PCBA. This tight integration reduces the number of components, permitting smaller size and simplicity.

Tightly integrating GPS chips into the clock design lets the ThunderBolt eliminate the piggy-backed GPS receiver. Instead of comparing a 1 PPS derived from an oscillator to a 1 PPS derived from an autonomous GPS receiver, the ThunderBolt uses the GPS measurements of bias and bias rate to steer the oscillator. This ovenized quartz oscillator is used as the local clock for GPS and the reference for the down-converting of the GPS signal. Better reliability, smaller size, and a cost advantage in high volumes are the results of the ThunderBolt's compact and simplified design.

Encased in the ThunderBolt is the GPS board and a 24V power supply regulator. This power supply ensures clean, robust power to the GPS. However, integrating the GPS board can be done without the case or power supply. This GPS board can support several different oscillators for applications having stringent holdover requirements.

The ThunderBolt is ready to use out of the box for most applications. With the oscillator warmed up and a GPS fix, the ThunderBolt begins outputting a 1 PPS and a reference frequency. It then begins a self-survey mode which allows use of an overdetermined time solution.

To get the most from your time reference, you can customize the ThunderBolt using Trimble's binary interface, TSIP (Trimble Standard Interface Protocol). TSIP and its ability to make ThunderBolt an even more powerful tool is discussed further in Appendix A.

The Trimble ThunderBolt GPS Disciplined Clock features the following:

- A quality ovenized oscillator on a single board
- An 8-channel GPS Receiver
- An Oscillator disciplined from GPS Bias and Bias Rate
- Low Phase Noise
- 10 MHz Reference Signal
- 1 PPS output with an overdetermined solution synchronized to GPS or UTC time
- Self-Survey Mode
- Signal Integrity through a T-RAIM (Time-Receiver Autonomous Integrity Monitor) algorithm
- Easy integration with Trimble's Bullet Antenna

1.2 Starter Kit

Your ThunderBolt Starter Kit is designed for a quick and easy installation. Included in this kit is everything that you will need to install and run the ThunderBolt.

1.2.1 Antennas

The ThunderBolt is made to match best with the Trimble Bullet Antenna. This antenna works with the ThunderBolt RF chip to provide high immunity to jamming.

It is important that your antenna has the fullest possible view of the sky to view the most satellites. To get the clearest view of the horizon in all directions, antennas are usually mounted permanently on a roof. For engineering purposes this may not be practical. Temporarily, your Bullet antenna can be placed near a window facing the southern sky (or northern sky in the southern hemisphere). See Chapter 2, pg. 2-2.

1.2.2 Cable

The Starter Kit comes with 75 feet of cable which is terminated on one end with a male "F" connector; the other end is unterminated. You can cut it to any length and terminate it with a male "F" connector from the Cable Termination Kit.

1.3 The Global Positioning System

The Global Positioning System (GPS) is a satellite-based navigation system operated and maintained by the U.S. Department of Defense (DoD). GPS consists of a constellation of 24 satellites providing world-wide, 24-hour, three-dimensional (3-D) coverage. Although originally conceived for military needs, GPS has a broad array of civilian applications including timing, surveying, marine, land, aviation, and vehicle navigation.

By computing the distance to GPS satellites orbiting the earth, a GPS receiver can calculate an accurate position. This process is called satellite ranging. A 2-D position calculation requires three satellite ranges. A 3-D position calculation, which includes altitude, requires four satellite ranges. GPS receivers can also provide precise time, speed, and course measurements which are beneficial for marine navigation and other applications, such as precise timing.

2 Getting Started

This chapter tells you how to install and operate the ThunderBolt, including:

- Antenna placement
- Antenna cable preparation
- Hardware interface
- Overview of basic features

2.1 ThunderBolt Setup

The following sections guide you in the electrical and mechanical preparation of the ThunderBolt for optimum performance.

2.1.1 Connecting the ThunderBolt

Before trying to connect the ThunderBolt, take a minute to consider the placement of the various components. The antenna requires a line of site to the satellites. The cable will need a port to reach an outside antenna. The ThunderBolt will also require a +24VDC power supply, a PC running Windows 95 (or later) or NT and any equipment needed to analyze the 10MHz and 1PPS. Review this chapter for tips on setting up and running the ThunderBolt for the first time.

2.1.2 Antenna Mounting

It is important that the ThunderBolt antenna has the fullest possible view of the sky. Getting the maximum number of satellites in view will get the best timing performance from the ThunderBolt.

Typically, antennas are mounted permanently on a high point such as a roof. Avoid overhanging objects such as trees and towers. Also take care to place the antenna away from low lying objects such as neighboring buildings that may block a portion of the sky near the horizon. If a full view of the sky is not possible, mount the antenna aiming towards the Equator to maximize the southern view of the sky (choose a northern view in the Southern Hemisphere) as shown in Figure 2-1. As a temporary solution the antenna can even be placed in a southern facing window. Under these circumstances the ThunderBolt will not have optimal timing performance.

Mounting standoffs for the Bullet antenna are commonly found at marine stores. Alternatively, your antenna can be mounted on a 3/4" pipe with 14 threads per inch.

Figure 2-1 Mounting the Bullet Antenna

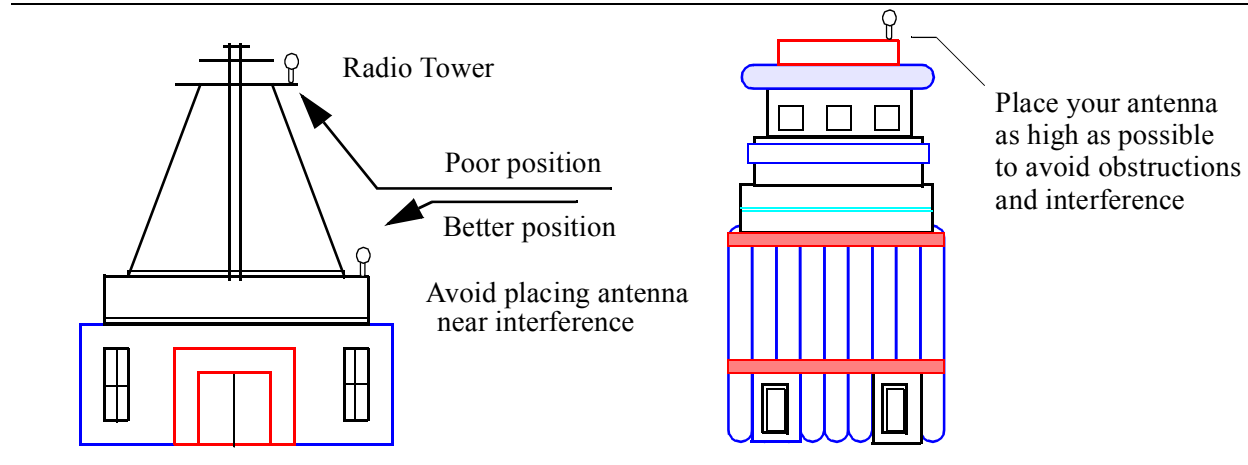
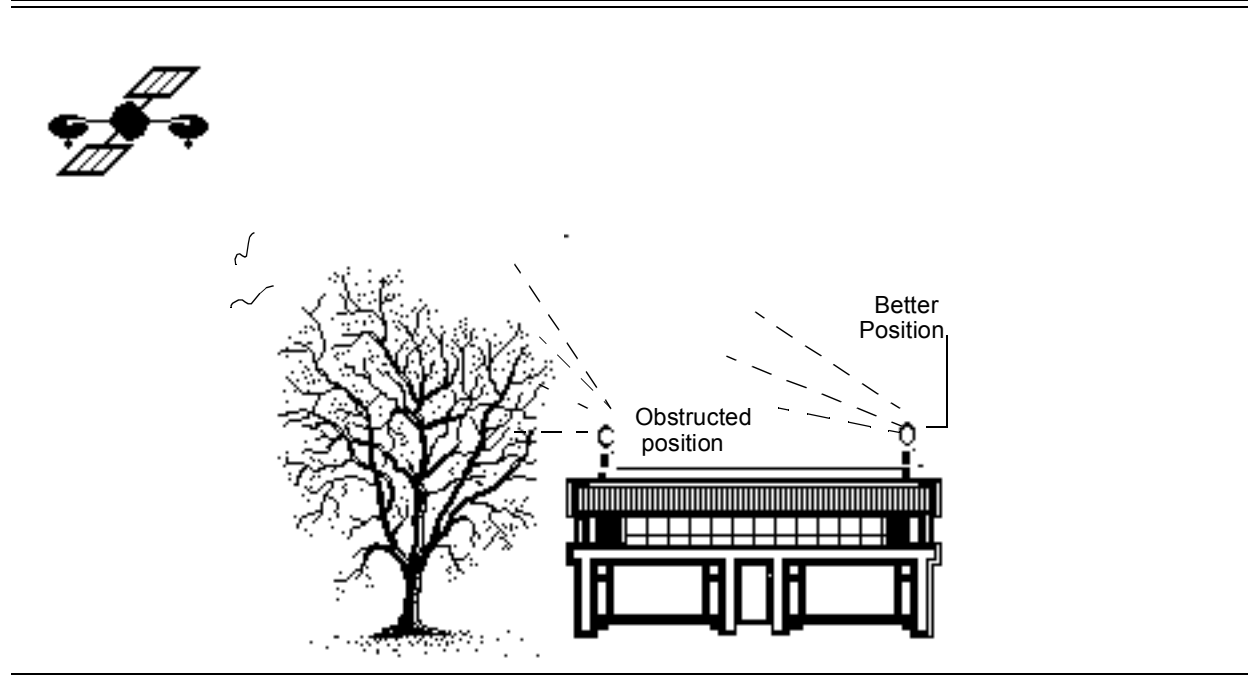
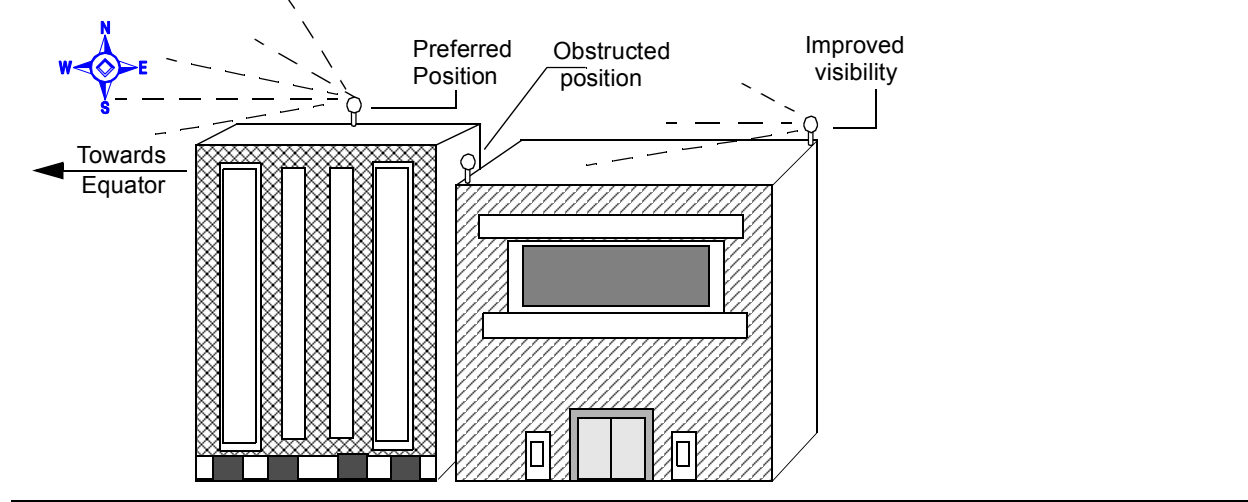
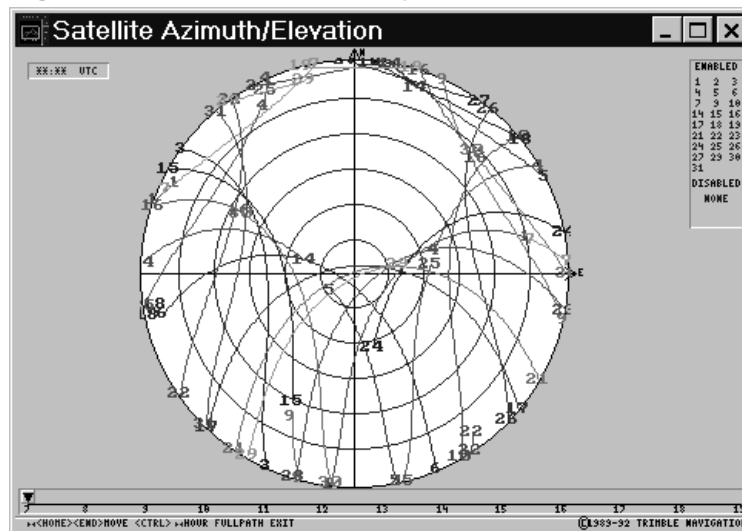

Figure 2-2 Satellite Density

Note – GPS satellites orbit from 60° North to 60° South. Although the GPS signal covers the entire earth, satellite density is greater when facing the Equator than the Poles, as illustrated on the sky plot in Figure 2-2. The curves in this figure represent the GPS satellites' path over a 24-hour period. To orient yourself with the diagram imagine lying on your back facing the sky with your head pointing north. The circle represents the full view of the sky from horizon to horizon. The 'hole' in the north part of the sky represents an area where there are no GPS satellites. The higher the latitude the closer the 'hole' moves toward the center of the sky. This graph represents the latitude of Hamburg, Germany.

2.1.3 Antenna Cable

Both the ThunderBolt and the Bullet antenna have female “F” connectors. The 75-foot cable that comes with the starter kit must be cut to a useful length and terminated. See “Terminating the Antenna with the “F” Connector”. When installing, avoid bending the cable sharply.



Tip – Trimble recommends RG-59 cable. The maximum practical cable run is just over 100 feet. See Chapter 3 for more information.

2.1.4 Terminating the Antenna with the “F” Connector

Your starter kit comes with 75 feet of cable. This can be cut to any length and terminated using the supplied connectors. When sizing the length of the cable make sure to include enough slack for a drip loop and for normal movements of the antenna. When you cut your cable, attach a male “F” connector to the cut end. Make sure that all contact surfaces are clean and firm before crimping.

Preparing Antenna Cable and Connectors

Instructions for preparing the antenna cable and connector are summarized below and described on the following pages. Follow these guidelines and instructions to ensure a successful installation.

- Mount the antenna
- Route the antenna cable
- Cut the cable to the desired length, allowing for a service loop
- Prepare the unterminated end of the cable for "F" connector (See "Exposing the Center Conductor" on page 4.)
- Attach the "F" connector (See "Attaching the "F" Connector" on page 5.)
- Attach the cable to the ThunderBolt

2.1.5 Preparing Cable for Termination

This section describes how to prepare the cable for termination.

Exposing the Center Conductor

Coaxial cable consists of a center conductor, a dielectric layer, a shield (that is, foil and wire wrapped around the dielectric), and a weather-resistant cable jacket. The center conductor supplies 5-volt (45 mA maximum continuous) power to the pre-amp in the antenna and carries the GPS signal back to the receiver for processing. The first step in preparing the cable is to expose the center conductor.

- Using an exacto-knife or razor blade, cut a square $5/16"$ section off the end of the cable to expose the center conductor. This will require that you cut through the cable jacket, the braid, and the dielectric (see Figure 2-3).

Figure 2-3 Expose the Center Conductor

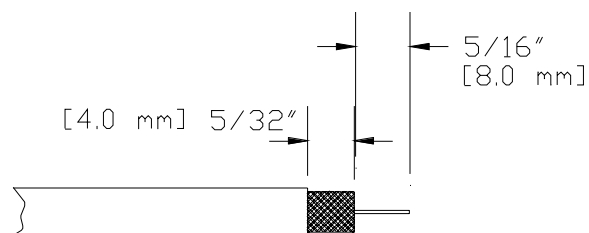

- Clean the center conductor to ensure that the exposed rim is smooth. If necessary, remove any residual dielectric or long braid strands that remain wrapped around the center conductor.
- Using an exacto-knife or razor blade, cut the cable jacket back another $1/8"$, leaving the dielectric and the shield intact. Be careful not to cut through these sections of the cable.

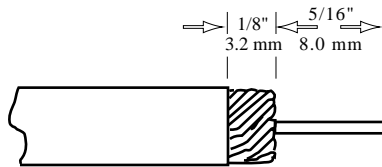
Figure 2-4 Cutting the Cable Jacket

- d. Fold the wire braid back over the cable jacket to expose the dielectric. Do not cut the wire braid, it must be folded back. Be careful not to tear the foil around the center dielectric.

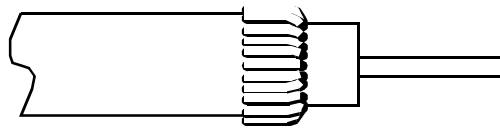
Figure 2-5 Fold Back the Shield

The cable is now prepared for the connector. Follow the instructions below to attach the "F" connector.

Attaching the "F" Connector

The supplied "F" connector is designed to be installed without the need of additional tools.

- a. Insert the stripped cable end into the rear of the "F" connector.
- b. Press and turn the connectors clockwise while holding the cable.
- c. Turn the connector until the cable center conductor extends 1/8" (3.2mm) beyond the end of the "F" connector.

2.1.6 Power

Apply 24V DC to the Mate-n-Loc connector and cable. Red is positive; black is return. The center connector (ground) is not necessary as all components are grounded to the case. The case uses a conductive allodyne coating to insure a strong ground.

For more detailed information on the Mate-n-Loc connector, see Chapter 3, Hardware Integration.



Note – After power is applied, the ThunderBolt will take fifteen to twenty minutes for the ovenized oscillator to warm up before it begins acquiring satellites. Once the ThunderBolt acquires satellites it begins a self-survey mode. The complete process can take an hour. Overall performance will improve after several days of continuous operation. 1PPS & 10MHz are available in the power up mode, but they will not be synchronized with GPS until the unit enters normal mode. For additional information, see Section 5.1.1.

2.1.7 Computer Connection

The ThunderBolt uses a standard RS-232 interface that can be connected directly to a PC.

Default Serial Port Configuration

The TSIP serial port is set at:

- 9600 baud
- No Parity
- 8-bit
- 1 stop/start bit

2.2 Software Interface

The CD included with the ThunderBolt starter kit (and online at the Trimble website) offers software programs that enable the user to monitor the ThunderBolt and change its settings.

2.2.1 ThunderBolt Monitor Program

The easiest way to familiarize yourself with the features of the ThunderBolt is by using the ThunderBolt Monitor Program. Install the program on a PC running Windows 95 (or later) or NT using the CD included in the ThunderBolt starter kit.

Figure 2-6 ThunderBolt Monitor Program

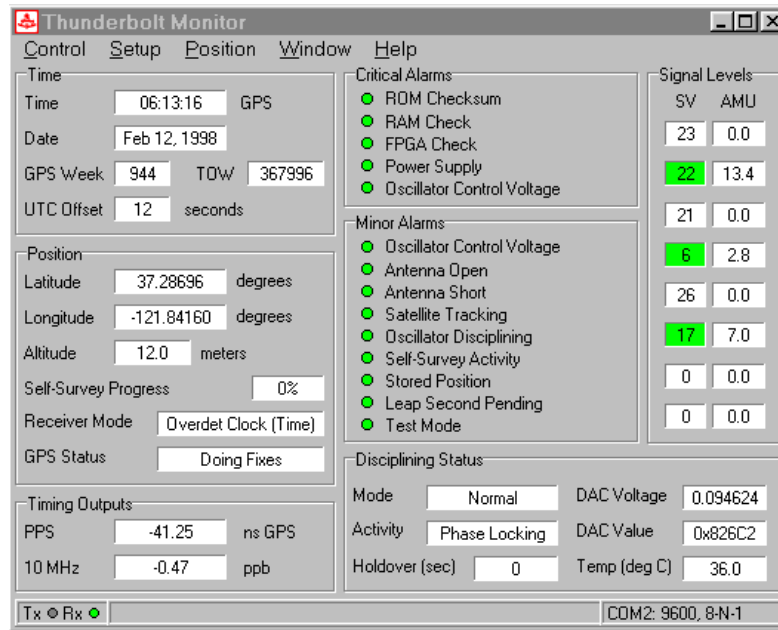

2.2.2 TSIPCHAT

The TSIPCHAT program is a DOS-based application designed to help the programmer in the development environment. The program reads TSIP report packets and prints them to the screen. It allows the user to exercise TSIP commands by translating the keystroke codes into commands which are output over the serial port.

TSIPCHAT Interface

The following Command Packets allow you to change the ThunderBolt configuration and operation settings.

To start the program, type `TSIPCHAT -c1` for COM1 or `TSIPCHAT -c2` for COM2. You can change your choice while TSIPCHAT is running by using the `[CTRL] +[I]` command.

As TSIPCHAT starts, it displays a command list in the upper half of the console screen (command window) and a running account of automatic (unrequested) reports in the bottom half of the screen (auto window). It also sets the serial port to the default settings of 9600 baud, 8-none-1.

If the receiver is alive and outputting time, Timing reports scroll immediately in the auto window. If the auto window is empty, type 'v' to test if the receiver responds within a second with the receiver software version numbers; otherwise, "waiting for reply" remains on the screen.

When issuing the TSIP command packet, use the [Space Bar] to scroll through the options. Use the [Return] key to set them.

Receiver COM Port Settings

Packet BC sets the ThunderBolt GPS port characteristics. To change these settings, use the TSIPCHAT program. [CTRL] + [Q] to change the receiver port. Use this command to set/request the Input/Output baud rate, data bits, parity, stop bits, and flow control parameters. Alternatively, you can use the ThunderBolt Monitor program by selecting Serial Communications from the Setup menu.

2.2.3 TSIP

TSIP (commonly pronounced tee-sip), Trimble's Standard Interface Protocol, consists of command packets and report packets. The Basic Features section describes some of the more commonly used commands and reports. A full description of TSIP can be found in Appendix A.

2.3 Basic Features

The following features are of general interest to the timing user. For a complete list of commands and reports see Appendix A.



Note – The packet number is not necessary if using the Windows Control Program.

2.3.1 Cable Delay Compensation

Packet 8E-4A allows the user to delay or advance the 1PPS. This may be desired to compensate for a long cable run. Negative values advance the 1PPS, used to compensate for cable delay. The 10MHz and 1PPS will remain synchronized.



Note – Factory default is zero.

2.3.2 Timing Information

Packets 8F-AB (Primary Timing Information) and Packet 8F-AC (Supplemental Timing Information) contain most of the information that the user needs to monitor the operation of the ThunderBolt. In the default configuration, these packets are broadcast once per second.

2.3.3 Elevation Mask

This is the minimum elevation angle for satellites to be used in a solution output by the receiver (see command BB in Appendix A). Satellites which are near the horizon are typically more difficult to track due to signal attenuation, and are also generally less accurate due to higher variability in the ionospheric and tropospheric corruption of the signal. When there are no obstructions, the receiver can generally track a satellite down to near the horizon. However, when this mask is set too low, the receiver may experience frequent constellation switching due to low elevation satellites being obscured.

Frequent constellation switching is associated with undesirable timing jumps. Too high a mask setting may reject good satellites. The current mask is set to five degrees and provides a reasonable trade-off of the benefits and drawbacks. High accuracy users may prefer a mask angle of around ten degrees, where the ionosphere and troposphere begin to be more predictable.

2.3.4 Signal Level Mask

This mask defines the minimum signal strength for a satellite used in a solution. There is some internal hysteresis on this threshold which allows brief excursions below the threshold if lock is maintained and the signal was previously above the mask. The factory default mask has been set to zero. High accuracy users may use a slightly higher mask of 6.0 to 8.0, since weaker measurements may be slightly noisier and are often caused by reflected signals which provide erroneous ranges.



Note – A level of hysteresis in the signal level mask is allowed in the core operating software. The hysteresis allows the receiver to continue using satellite signals which fall slightly below the mask and prevents the receiver from incorporating a new signal until the signal level slightly exceeds the mask. This feature minimizes constellation changes caused by temporary fluctuations in signal levels.

2.3.5 Reference Position

Once the antenna is connected and power is applied, the GPS module generates a precise PPS (pulse per second) signal, a 10 MHz frequency output, and several miscellaneous periodic outputs. It calculates a clock-only solution from the GPS data. In clock-only (position-hold) mode, a static reference position is established and all of the available satellites are used to solve for a time solution. The reference position may be determined automatically by the ThunderBolt (self-survey) or may be uploaded to the ThunderBolt by the host, if the position is known. The accuracy and integrity of the timing solution is highly dependent on the accuracy of the reference position.

If the host has not uploaded a reference position, the GPS module will automatically conduct a position survey at power on. By default, the GPS module will average position fixes for 2000 fixes before entering the clock-only mode. The survey period may be adjusted by the host system using Packet 8E-A6. While the GPS module is performing its survey, the accuracy of the timing outputs will be degraded.

Entering a Reference Position

The user may use Packet 31 (XYZ ECEF) or Packet 32 (Latitude, Longitude, Altitude) to upload an accurate reference position. This reference position will be stored in EEPROM and will be retained during power loss. With a reference position stored in EEPROM, the GPS module bypasses the position survey procedure and enters clock-only mode. If the antenna is moved, the user must send Packet 8E-45 to clear the position stored in EEPROM. When the reference position is cleared, the GPS module will initiate a self-survey, unless the host uploads a new position using Packet 31 or Packet 32.

To store the reference position from the self-survey procedure in the EEPROM, send Packet 8E-4C to the receiver. Alternatively, the ThunderBolt can be configured to automatically save the position using packet 8E-A9.

2.4 Maintenance

The ThunderBolt will provide years of maintenance-free operation. Should the unit experience a problem, you will be warned with a visual alarm through the monitor program. Contact Trimble for technical direction and repair. There are no user-serviceable parts inside the ThunderBolt and removing the cover will void the warranty.

3 Hardware Integration

General information on using the ThunderBolt for the first time is included in Chapter 2. This chapter covers details of the hardware interface necessary for integration into a user's system.

3.1 ThunderBolt GPS Disciplined Clock

The ThunderBolt consists of two boards mounted inside an aluminum case. The board pictured on the right contains the parts for power regulation and is mounted on the bottom of the case. The second board contains the GPS receiver, the Oscillator, and disciplining circuitry. This board is mounted above the power board. The ThunderBolt is sold both as a complete module, or as a GPS board only (no power supply or sheet metal).

Figure 3-1 ThunderBolt Clock Components

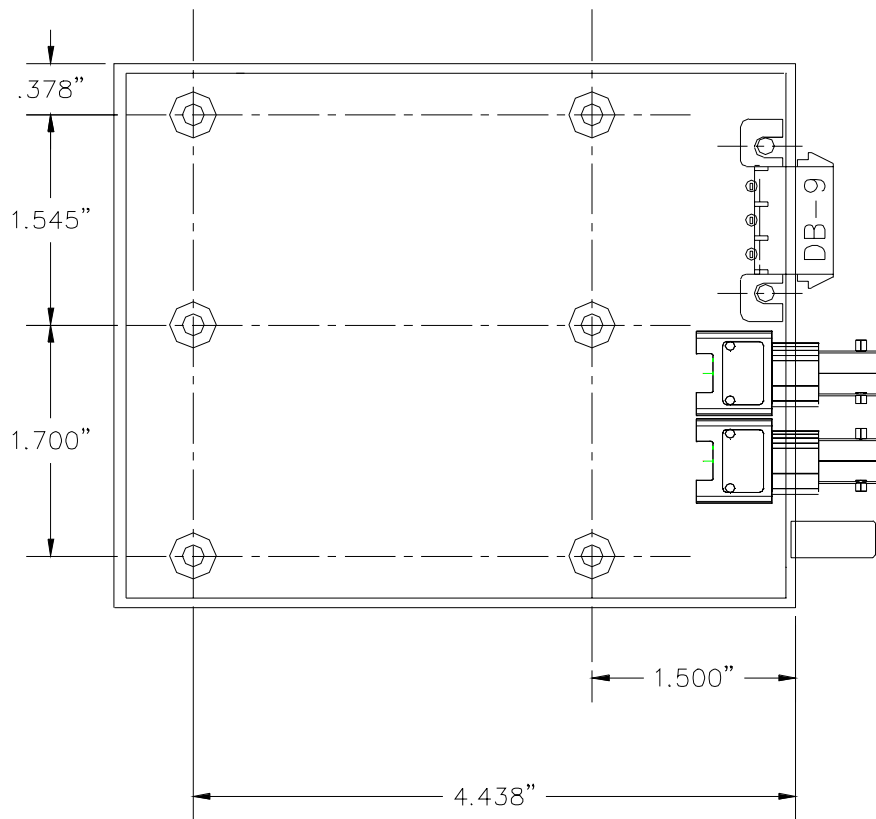

Figure 3-2 ThunderBolt Clock Module Dimensions

Note – The base mounting screw holes (6) will accommodate a #6/32 x 3/8 machine screw. When mounting the ThunderBolt onto a plate for permanent mounting, take into consideration the length of screw and thickness of plate so that you do not protrude into the ThunderBolt and potentially damage electronics.

Figure 3-3 ThunderBolt Board-Only Mechanical Drawing

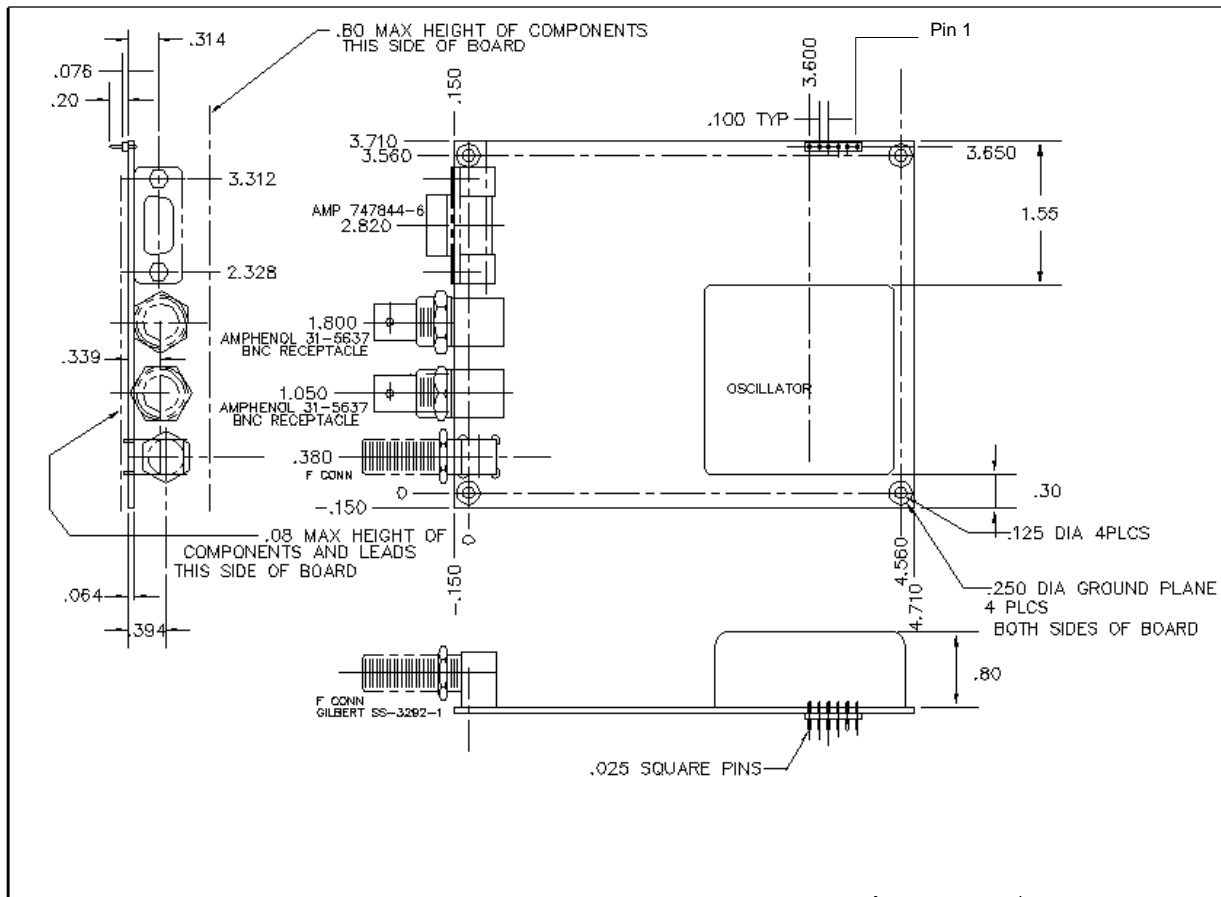

3.2 Power Connector Pin-Out and Part Numbers

Table 3-1 shows pin-out information for the 6-pin power interconnect header on the ThunderBolt board (pin 1 is marked on the connector).

Table 3-1 Power Connector Pin-outs

Pin #	Description	Purpose
1	+12V	Prime Voltage for the OXCO
2	Ground	Power Ground
3	+5V	Load Share Voltage, Logic & I/O
4	+5V	Load Share Voltage, Logic & I/O
5	Ground	Power Ground
6	-12V	Prime Voltage for the OXCO

The 6-pin power connector used on the ThunderBolt GPS receiver board is SAMTEC TLW-106-06-G-S.

The recommended mating connector (as used on the ThunderBolt power supply board) is SAMTEC SLW-106-01-G-S for 0.25" board-to-board connections.

Table 3-2 shows current and ripple requirements to power the ThunderBolt.

Table 3-2 Power Specifications (Board-only)

+12v	+/-10% max current 750 mA
+5v	+/-5% max current 400 mA
-12v	+/-10% max current 10 mA
Ripple	
+5v	50 mV peak-to-peak, 15 mVrms
+/-12v	75 mV peak-to-peak, 20 mVrms

3.3 Interface Connector Pin-Out Table

The RS-232 serial port uses a DB-9 connector. The pin-out functions are shown in Table 3-3, for both the complete ThunderBolt module and the GPS Board only. This configuration supports connections to the RS-232 serial port on a computer.

Table 3-3 Serial Data Connector Pin-outs: ThunderBolt Module

Pin	ThunderBolt Module	
	Function	Signal/Protocol
1	Not Used	
2	TxD	Transmit out/RS-232
3	RxD	Receive in RS-232
4	Not Used	
5	Ground	
6	Not Used	
7	Not Used	
8	Not Used	
9	Not Used	

3.4 Antenna Cables

RG-59 cable is recommended due to its use in cable television networks. It is widely available and inexpensive. Two RG-59 cables qualified for use with the Trimble GPS modules are Belden, part number 82108 and Times Fiber, part number 32245. The RG-59 cable specifications are in Table 3-4, “RG-59 Cable Specifications.” Trimble recommends that you select a cable meeting or exceeding these specifications.



Note – RG-59 is a 75 ohm coaxial cable. The ThunderBolt and the Bullet antenna are compatible with either 50-ohm or 75-ohm cable. **Compared to most 50 ohm cable, 75 ohm cable provides superior transmissibility for the 1.5 GHz GPS signal and a better quality cable for the price. Mismatched impedance is *not* a problem.**

Note – The input impedance of the ThunderBolt RF input & its antenna is 50 ohms.

Table 3-4 RG-59 Cable Specifications

Type	RG-59
Impedance	75 ohm
Capacitance	16.5 pF/Foot (54.1 pF/meter)
Vel of Propagation	84%
Shielding	Foil and copper braid (100% coverage)
Connectors	Waterproof F-type
Signal attenuation	<10dB for cable and connectors

RG-8 cable is lower loss than RG-59 and can be used when trying to maximize a cable run without the use of inline amplifiers.

The following graphics compare RG-8 cable and RG-59 cable:

Figure 3-4 RG-59: Loss vs. Length

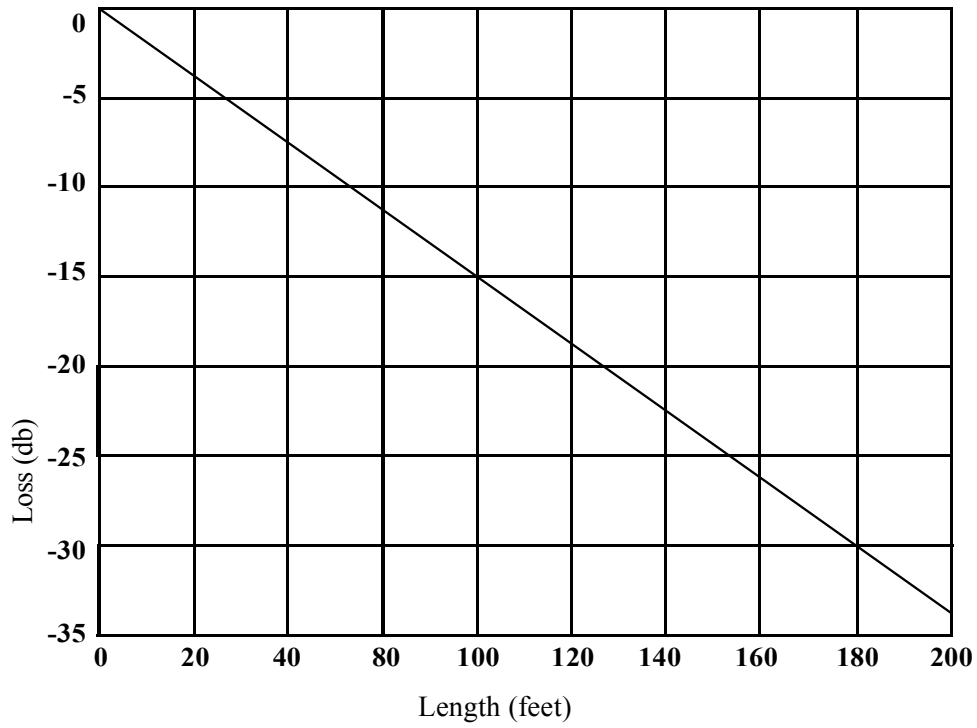
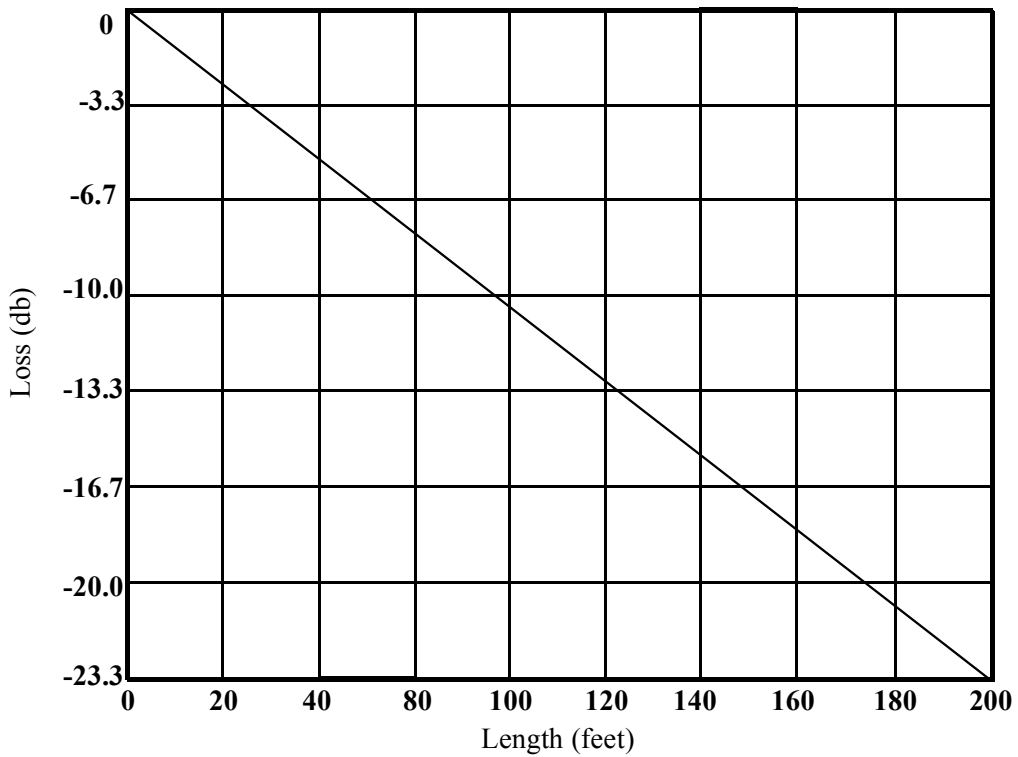

Figure 3-5 RG-8: Loss vs. Length



3.4.1 Routing/Securing Cable

After mounting the Bullet antenna, route the cable from the antenna to the receiver. Choose the most direct path to the receiver while avoiding the following hazards:

- Sharp Bends or Kinks in the Cable
- Hot Surfaces (Exhaust Manifolds or Stacks)
- Rotating or Reciprocating Equipment
- Sharp or Abrasive Surfaces
- Door and Window Jambs
- Corrosive Fluids or Gases

You should secure the cable using tie-wraps. When securing the cable, start at the antenna and work towards the receiver. Provide strain relief for the antenna cable connections by ensuring that the cable is secured at points close to the antenna and the receiver. Additional protection (for example, heat-shrink tubing) may be required to protect the cable jacket at points where the opening is rough or sharp, such as where it enters or exits bulkheads.



Note – Provide a service loop in the cable near the antenna to allow for disconnection of the antenna and to allow moisture to drip away from the connections.

Once the cable is secured, the receiver end of the cable can be cut (if applicable) to an appropriate length. Leave enough slack to allow for easy connection to the receiver and to account for normal movement of the receiver (for example, gimbal or swivel mounts). The final step, if applicable, is the installation of the connector on the receiver end of the cable.

3.5 Power Supply and Connector

The ThunderBolt comes with a 24V power supply regulator. A locally supplied +24VDC is required. Power consumption is 15 watts cold and 10 watts steady state. The connector is an AMP mate-n-loc (AMP part number 643228-1). The AMP mate-n-loc mating connectors are listed in the table below. An AMP hand tool (PN 90300-2) may be required to assemble this connector.

Table 3-5 Power Supply Mating Connector (AMP Part Numbers)

Description	AMP Part Number	Quantity Required
Connector plug	1-480700-0	1
24-18 AWG pre-tinned brass pins	350706-1	2
Strain relief (optional)	1-640720-0	2



Note – The ThunderBolt uses a case ground scheme so that only two contacts are used, left and right. The center (ground) is left empty.

It is possible to integrate The ThunderBolt at the board level without the power supply. The Prime power is +12V, -12V, +5v, and ground. Contact your Trimble sales representative for further information.

3.6 Bullet Antenna Specifications

Table 3-6 describes the physical characteristics of the Bullet antenna.

Table 3-6 Physical Characteristics

Dimensions	3.05" diameter x 2.61" height (77.5mm x 66.2mm)
Bullet enclosure	Textured, off-white plastic
Antenna Weight	6.oz. (170 grams)
Connector	F-type or TNC
Mount	1"-14 thread or 3/4" pipe thread

Table 3-7 provides the environmental specifications for the Bullet Antenna.

Table 3-7 Environmental Specifications

Operating Temperature	-40°C to +85°C
Storage Temperature	-40°C to +100°C
Vibration	0.04g ² /Hz 10 Hz to 500 Hz 0.03g ² /Hz 500 Hz to 850 Hz 0.02g ² /Hz 850 Hz to 1200 Hz
Shock	50g vertical, 30 g all axes
Humidity	Mil-STD-810E
Salt Fog	Mil. Std. 202F, Method 101D Condition B
Waterproof	Submersion to 1 meter

4 Software Interface

The Trimble Standard Interface Protocol (TSIP) is described completely in Appendix A. This section includes information helpful to the developer understanding the structure of the ThunderBolt firmware.

4.1 Firmware Configuration

The ThunderBolt maintains its configuration parameters in a non-volatile memory device called an EEPROM (Electrically Erasable Programmable Read-Only Memory.) Related configuration parameters are grouped together and stored in an area of EEPROM called a “segment” (there are seven user configurable segments). Immediately after a reset, the ThunderBolt reads the contents of these segments from the EEPROM and stores a working copy in RAM. The ThunderBolt then configures itself based on the working copy of the segments. The user can modify the contents of these working copies using the “Set” command packets listed in Appendix A. Likewise, the working copies of the segments can be read by issuing the “Request” command packet and waiting for the “Report” packet response. When the user alters a parameter, the ThunderBolt reconfigures itself accordingly, but the contents of the EEPROM are not changed automatically.

The ThunderBolt provides two command packets for controlling the contents of the segments stored in EEPROM. Command packet 0x8E-4C allows the user to save the contents of any or all working copies of the segments to EEPROM. Command packet 0x8E-45 allows the user to set the contents of any or all the segments stored in EEPROM to the “Factory Default” setting listed in the table below.

The tables in Appendix A provide details on each of the seven user configurable segments.

4.2 Firmware Upgrades

When firmware upgrades are available Trimble will provide software and instructions on the ThunderBolt Support site at www.trimble.com.

4.3 Firmware Features

The firmware includes:

- Kalman Filtering for better performance during holdover (for more information, see Operations).
- 1 PPS Calibrated to the USNO Master Clock for a more accurate “out of box” performance.
- New Position Integrity Monitor that warns the user if the receiver is using an incorrect position.
- User Selectable Recovery Algorithm that allows the user to define how the clock will recover from holdover.
- Silent TSIP Options that allows the user to choose which packets, if any, are to be reported.

4.4 Windows Control Program

A Windows program is available that demonstrates the abilities of the ThunderBolt. The program is highly intuitive, and is excellent as a familiarization tool, but is not intended for development or implementation. The source code is not available.

5 Operations

5.1 General GPS Description

Every GPS satellite transmits the Coarse/Acquisition (C/A) code and satellite data modulated onto the L1 carrier frequency (1575.42 MHz). The C/A code is a unique pseudo-random number for each satellite. The satellite data transmitted by each satellite includes a satellite almanac for the entire GPS system, its own satellite ephemeris and its own clock correction.

The satellite data is transmitted in 30-second frames. Each frame contains the clock correction and ephemeris for that specific satellite, and two pages of the 50-page GPS system almanac. The time required to transmit the complete system almanac is 12.5 minutes and the time to transmit the satellite ephemeris is 30 seconds.

The system almanac contains information about each of the satellites in the constellation, ionosphere data, and special system messages. The ephemeris contains detailed orbital information for a specific satellite. The GPS system almanac changes infrequently and is typically valid for weeks. Ephemeris data changes hourly, but is valid for up to four hours. The GPS control segment updates the system almanac weekly and the ephemeris hourly through three ground-based control stations. During normal operation, the ThunderBolt updates the ephemeris stored in its memory at 30 minute intervals.

The performance of a GPS receiver at power-on is determined largely by the availability and accuracy of the satellite ephemeris data and the availability of a GPS system almanac.

5.1.1 Oscillator Disciplining Basics

We use the term “discipline” to refer to the process of adjusting the frequency and phase of the ThunderBolt timing outputs into alignment or synchronism with an external reference source, namely GPS.

GPS receivers, like all radio receivers, require a local reference oscillator in order to detect and decode the incoming RF (radio-frequency) signal. The ThunderBolt GPS receiver electronics are designed to accept a 10 MHz reference oscillator frequency. The GPS receiver electronics, in conjunction with the CPU and support circuitry, divides this 10 MHz reference down to a 1 PPS signal. Based on measurements taken with the GPS receiver electronics and information transmitted by the satellites, the ThunderBolt is able to determine the frequency offset of the 10 MHz reference and the phase offset of the 1 PPS output relative to GPS or UTC. By knowing this offset information, the ThunderBolt can cause these timing outputs to move into sync with GPS or UTC by adjusting the frequency of the 10 MHz clock and by shifting the 1 PPS output.

The frequency of the 10 MHz clock is adjusted with the help of a Digital-to-Analog Converter (DAC.) The CPU's firmware determines how much to adjust the frequency based on GPS measurements and information. The DAC gets a number from the CPU and converts it into an analog voltage which is fed to the control voltage input of the 10 MHz oscillator. Variations in the control voltage produce corresponding changes in the frequency of the oscillator. Changing the frequency of the oscillator also causes the 1 PPS offset to change. The ThunderBolt corrects for small errors in PPS offset by adjusting the frequency of the oscillator only and not by shifting the PPS. This process is called "phase locking". The ThunderBolt spends most of its time in this phase locking mode.

When the ThunderBolt first begins to synchronize to UTC/GPS, there will be a large PPS offset. In order to correct for this offset quickly, the ThunderBolt will shift the PPS output into alignment. The resolution of this shift is 100 ns and is due to a 10 MHz clock that drives the PPS shifting circuitry. What this 100 ns resolution means is that the PPS shifting mechanism can align the PPS to UTC/GPS only to within +/- 50 ns, but it can do it instantly. The rest of the PPS correction must be achieved with the phase locking technique described above and is a gradual process.

At any given time, the ThunderBolt disciplining mechanism can be described as being in one of several states. The mechanism transitions from one state to the next in response to the conditions described below.

From reset, the ThunderBolt disciplining mechanism enters the Power-Up state. In this state, the oscillator is allowed to warm up to an adequately stable state. At this point the GPS receiver electronics are beginning to track satellites, and time or position fixes become available. The initial synchronization process begins by adjusting the frequency of the oscillator based on the frequency offset information only. At the same time, the PPS output is constantly shifted into place. Once the frequency is close, the unit shifts into one of its phase-locking modes and the timing outputs begin to settle in. After a period of settling, the ThunderBolt transitions to the Normal state.

Figure 5-1 ThunderBolt Disciplining State Diagram

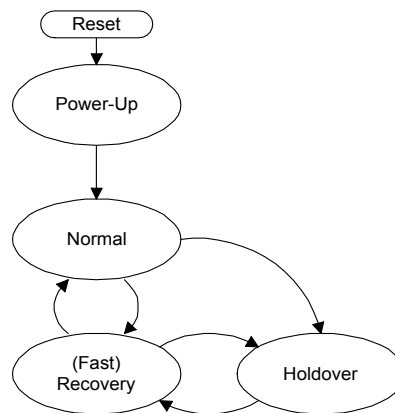

In the Normal state, the ThunderBolt maintains the synchronization of the timing outputs using phase-locking. As long as valid GPS signals and measurements are received, the ThunderBolt can operate normally. Any disruption in the GPS receiver (e.g., loss of GPS

signal) will cause the ThunderBolt to transition into the Holdover state. The user can instruct the ThunderBolt to transition to the Recovery state with command packet 0x8E-A3.

In the Holdover state, the ThunderBolt relies, to a high degree, on the stability of the 10 MHz oscillator to maintain the integrity of the timing outputs since they cannot be disciplined to GPS in this state. While the ThunderBolt is in the Normal state, it attempts to learn as much about the stability characteristics of the oscillator as possible. If the ThunderBolt has spent sufficient time in the Normal state (e.g., 24 hours) then some of the instability of the oscillator is removed during holdover based on what the ThunderBolt has learned about the oscillator. When valid GPS signals return, the ThunderBolt will transition to the Recovery state.

In the Recovery state, the ThunderBolt removes any PPS phase or 10 MHz frequency offset from UTC/GPS that was accumulated during Holdover. This is accomplished by either quickly shifting the PPS into alignment (jam sync) or by more slowly shifting the frequency of the 10 MHz oscillator by a specified amount until the PPS has slewed back into alignment or by using both methods. The user can control the Recovery process with parameters set with packet 0x8E-A8. If a fast recovery is desired, then the users should allow jam syncs (PPS shifting) to be used. If it is important to maintain 10 million clock cycles per PPS pulse then disable jam syncs and set the maximum 10 MHz frequency offset to a tolerable value.

Two holdover states are defined: Auto Holdover and Manual Holdover. Both states function as described above. The Auto Holdover state is entered automatically whenever the ThunderBolt detects a loss of valid GPS signals. The Manual Holdover state is entered in response to a user command (packet 8E-A3) and is intended to be used for testing purposes. The ThunderBolt will transition out of Auto Holdover mode on its own, but the user must command the unit to leave Manual Holdover. If the ThunderBolt is not receiving valid GPS signals when instructed to leave Manual Holdover, then it will enter the Auto Holdover state.

One final state is defined, but not shown on the state diagram. The Disabled state is entered (and left) in response to a user command (packet 8E-A3.) In the Disabled state, timing output control by the ThunderBolt routines is completely halted. This is different from the Holdover states which allow the ThunderBolt to continue to control the timing outputs based on learned behavior. The Disabled state allows the user to set the oscillator frequency control voltage directly using command packet 8E-A0. No other state allows the user to set the control voltage. This state is used by the factory to perform production tests, but may be useful to users for testing.

5.1.2 Kalman Filtering

Kalman filtering is a technique that improves the performance of a GPS disciplined clock when GPS drops out. This state is called holdover. During holdover the clock relies solely on the oscillator. Oscillator performance is subject to two basic effects. First, changes in environmental temperature can cause the oscillator to speed up to slow down. Second, the oscillator has a natural tendency to drift over time. This is called aging. Both temperature and aging can be mathematically predicted. However, the characteristics vary from crystal to crystal. The Kalman filtering monitors the unique oscillator performance over time and temperature and records this behavior. Then when the clock goes into holdover this filtering corrects for these effects producing a more accurate clock. The longer a clock has to 'train' the better the Kalman filtering performance will be. 24 hours is considered the minimum necessary for good performance

5.1.3 Oscillator Performance

Oscillator performance is a key component of a GPS disciplined clock. Understanding some basic characteristics of oscillators will help you understand the ThunderBolt performance under various circumstances.

Oscillators work by outputting a frequency. A perfect oscillator would have a frequency that looked like a sine wave. Each cycle would be identical to every other cycle. However, no oscillator is perfect and the output of a real oscillator looks like a series of imperfect sine waves, each one varying slightly from the last. This variation is important because no matter how slight, the variations add up. It adds up in a way that is not intuitively obvious. Consider the performance of a real-life oscillator compared to some perfect measurement of time. Plot fast performance above the X-axis and slow performance below the X-axis. In a period of a few seconds the error of the quartz oscillator will appear as white noise. The white noise error is evenly spaced above and below the X-axis at "0" representing truth.

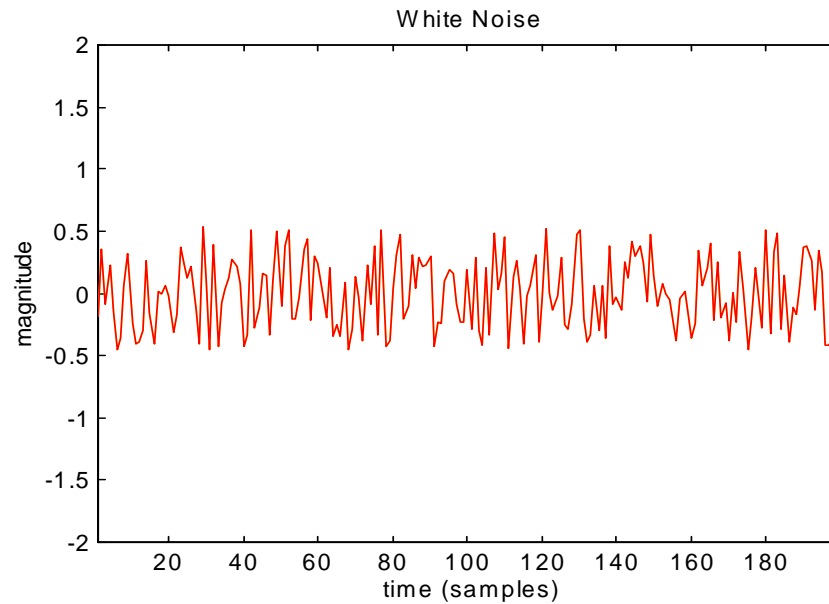
Figure 5-2 White Noise

As time passes, errors begin to add up and the oscillator starts to drift from truth. This drift becomes more dramatic over longer periods. Mathematically the nature of the oscillator performance changes. White noise has a statistical average or mean that is zero. Over longer periods the oscillator's mean is constantly changing. This creates a “random walk” pattern.

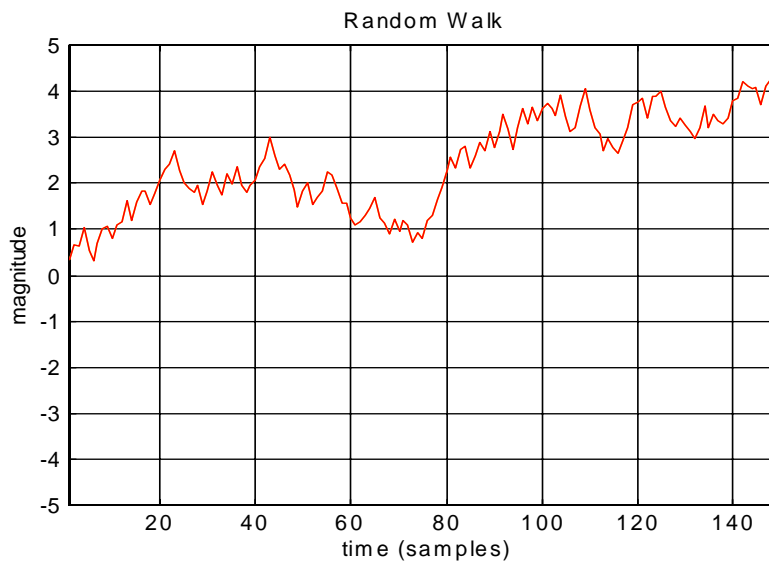
Figure 5-3 Random Walk

Allan Variance

One way to look at oscillator performance is with a diagram called an Allan Variance. The Allan Variance simply plots oscillator performance versus time. This diagram may look confusing at first, but is really very simple.

Figure 5-4 Allan Variance

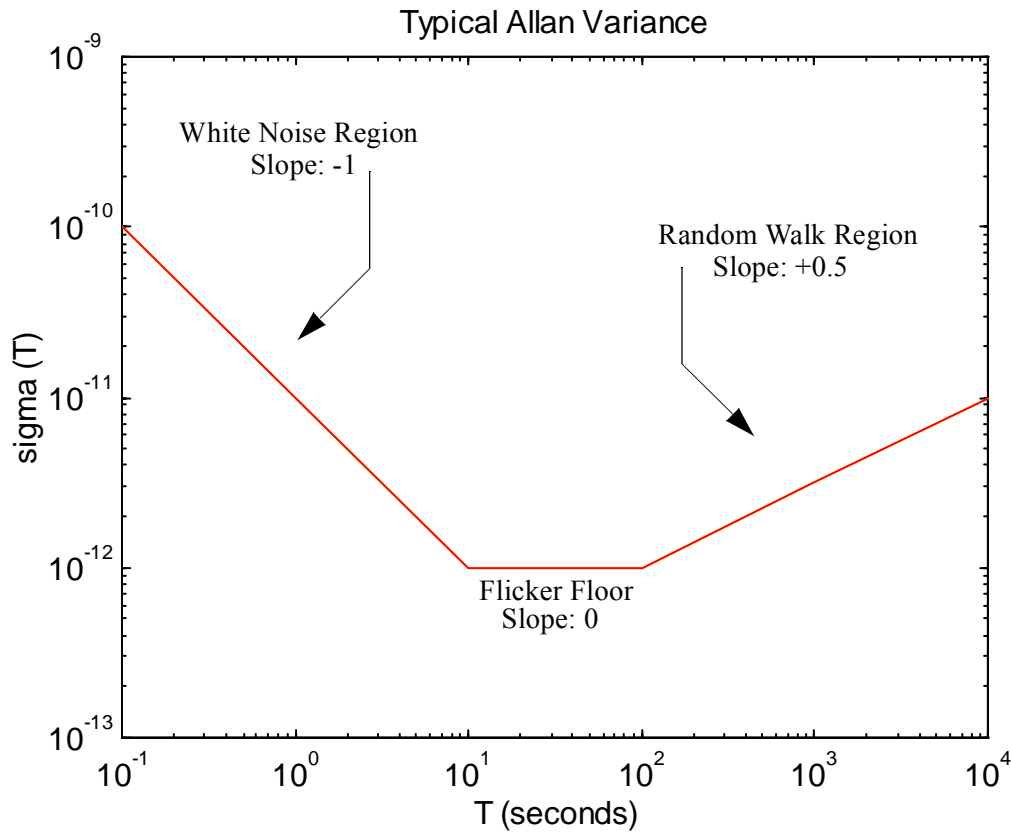

The downward slope represents the area of white noise. Lower is better. Notice that the line decreases with time. An intuitive way to think about the Allan Variance is to think of the distance from the X-axis to the line as the slope of a line that can be drawn through a section of oscillator performance.

A short sample of oscillator performance allows room for a steep line to be drawn. A longer sample restricts the slope. The shallower slope corresponds to better performance.

In the first few seconds the performance becomes better as the measurement time increases. However, the variations start to add up and the performance starts to wander. The magnitude of this wander increases until it approaches a random walk.

A random walk has no mean. It is a curious characteristic in nature. It is not unique to oscillators. If you toss a coin and plot one square up for heads and one square down for tails it will exhibit the same sort of behavior as an oscillator over time, white noise in the short term, the flicker floor and eventually a random walk.

Other Conditions Affecting Oscillator Performance

You will find other conditions that affect oscillator performance. Temperature will change the output of an oscillator. It is well known that oscillators are very sensitive to temperature variations. One of the things that can be done to protect quartz from temperature changes is to place the crystal inside a heated oven. Typically, an ovenized oscillator will be heated up to 85°C while the ambient temperature changes between 0°C to 70°C. Quartz performance will also change with age. However, the performance will tend to become more consistent with age.

Allan Variance of GPS

GPS will remove variation due to temperature, age, and random walk from the oscillator performance. The Allan Variance for GPS will be a straight line that constantly decreases.

The output of GPS is very precisely controlled by a series of atomic clocks and corrections from ground stations. The variation is white noise, but it does not have a random walk or flicker floor.

Figure 5-5 Allan Variances with GPS

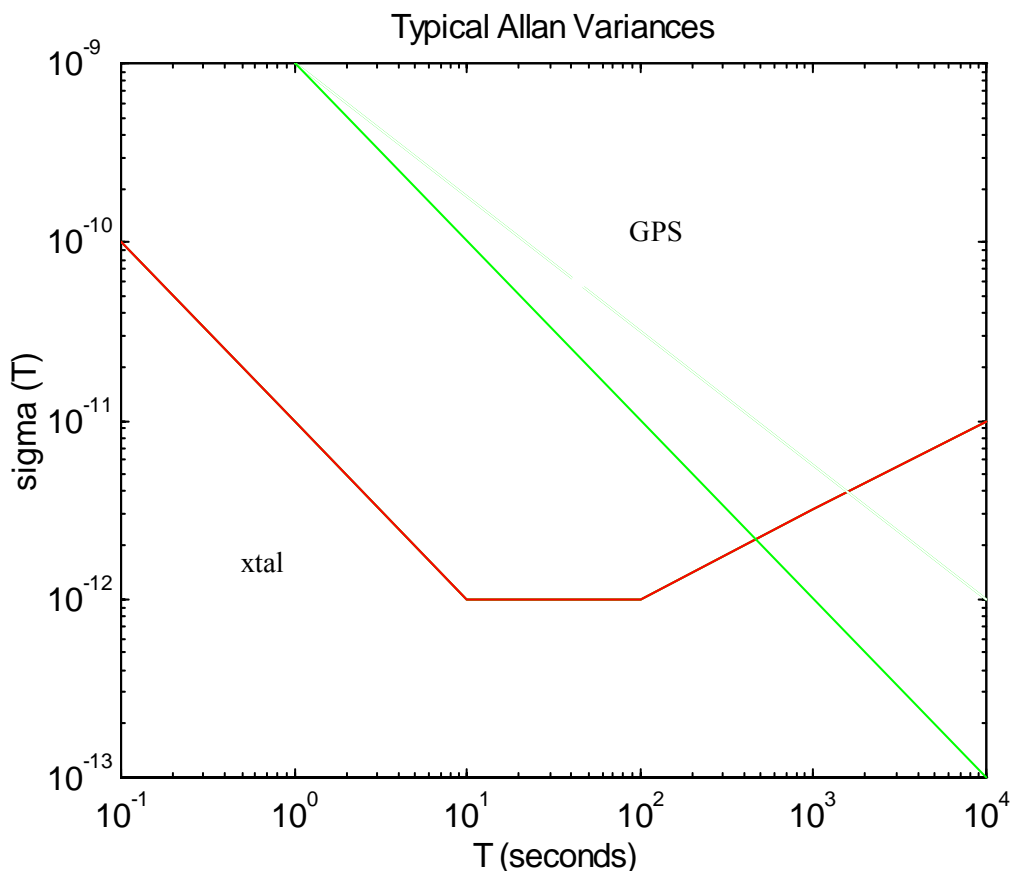

GPS + Oscillator

The key is to correct the oscillator with GPS just before the oscillator starts into random walk.

5.2 Timing Between Sites

Many customers are interested in synchronizing between wireless base-stations and want to know if two units viewing the same set of satellites will track more closely than two units viewing independent sets of satellites. Data shows that unit to unit performance is on the order of ± 15 nanoseconds (three sigma). This does not include any static time offset that may exist between two units. Static time offsets can be determined by comparing one ThunderBolt under test to a known standard or gold unit.

5.3 GPS Timing

GPS disciplined clocks are used in many applications such as time/frequency standards, site synchronization systems, wireless voice and data networks, and event measurement systems. The steering algorithm combines the short-term stability of the oscillator with the long-term stability of GPS. This added GPS discipline allows the use of ovenized quartz oscillators which have poorer stability than atomic oscillators such as rubidium cells, but which are much more reliable and cost-effective.

The GPS constellation consists of 24 orbiting satellites. Each GPS satellite contains a highly stable atomic clock (cesium), which is continuously monitored and corrected by the GPS control segment. Consequently, the GPS constellation can be considered a set of 24 orbiting clocks with world-wide 24-hour coverage.

GPS time accuracy is bounded by the same sources of error that limit position accuracy (see Table 5-1).

Table 5-1 GPS Error Sources

Error Source	1 Standard Deviation
Atmospheric Models (Ionosphere)	5 - 50 ns
Receiver noise (Multipath)	1 - 20 ns
Satellite Clock Model	10 ns
Satellite Orbit Model	5 ns
Antenna Survey	1 ns

GPS disciplined clocks take advantage of these facts by gently steering the crystal oscillators with a filtered GPS signal. The key is to allow the oscillator a free reign until it starts into a random walk phase. At that point the GPS comes into play by increasing or decreasing a steering voltage. This speeds up or slows down the oscillator, guiding it back toward UTC or GPS time.

5.3.1 Timing Operation

The ThunderBolt is designed and configured for static timing and synchronization applications. Once power is applied, the ThunderBolt automatically acquires GPS satellites, computes position and time fixes, outputs a PPS and 10 MHz signal, and conducts a self-survey for 2000 fixes to establish an accurate reference position. With an accurate reference position acquired, the ThunderBolt automatically switches to over-determined clock mode, activates its T-RAIM algorithm and outputs a precise PPS. The over-determined clock solution mitigates the effects of S/A by using all available satellites to formulate a timing solution that is more accurate than any single timing solution.

The ThunderBolt default configuration provides optimal timing accuracy without intervention from the user. The one item the user or host controller may want to modify is the delay introduced by the antenna cable. Cable delay can be significant (1.25 nanoseconds per foot). The ThunderBolt is shipped from the factory with zero cable delay. Testing at the United States Naval Observatory shows that the PPS is on time compared to UTC/GPS with no cable; for example, a ThunderBolt with a bullet II HE antenna directly on the connector would be on time. Any cable will delay the PPS. Adding a cable delay correction (see packet 0x8E-4A) will shift both the 1PPS and the 10 MHz together. The maximum recommended cable delay is an entry of 50 milliseconds.

UTC vs. GPS Time

Please note that GPS time differs from UTC (Universal Coordinated Time) by a variable, integer number of seconds, as described below.

$$\text{UTC} = (\text{GPS time}) - (1 \text{ GPS to UTC offset})$$

As of January 1999, the GPS to UTC offset was 13 seconds. Historically, the offset increases by one second approximately every 18 months. System designers should plan to read the offset value as a part of the timing interface to obtain UTC. The GPS week number is in reference to a base week (Week #0), starting January 6, 1980. The GPS and UTC systems are based on the same second. However, UTC adds or subtracts leap seconds to compensate for the slowing motion of the Earth. Since the systems run independently, at any one time there may be as much as 1microseconds difference between the systems. Historically the difference is less than 100 nanoseconds. The GPS receiver automatically corrects for this difference. It is important to remember that any real-time UTC is actually a prediction of UTC. The official UTC time is published approximately one month after the fact. For more information on UTC, refer to the US Naval Observatory or National Institute of Science and Technology (NIST) web pages (see the Reference section).

Timing Pulse Output (PPS) and 10 MHz

Several options are available for the timing outputs. The PPS can be turned off and on, and the polarity for both the PPS and 10 MHz can be set by the user.

Figure 5-6 PPS with rising edge

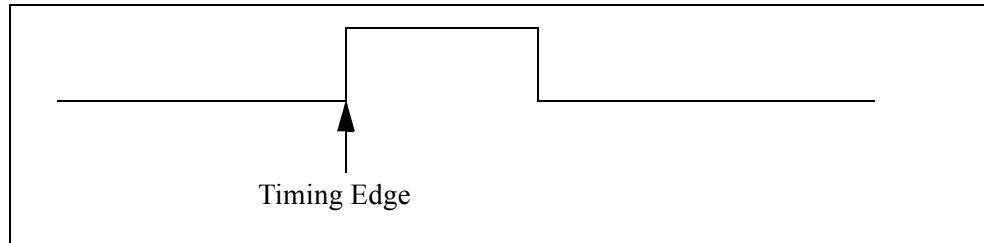

Figure 5-7 PPS with falling edge

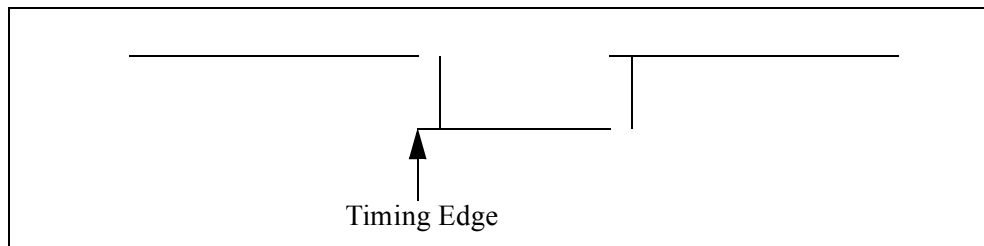
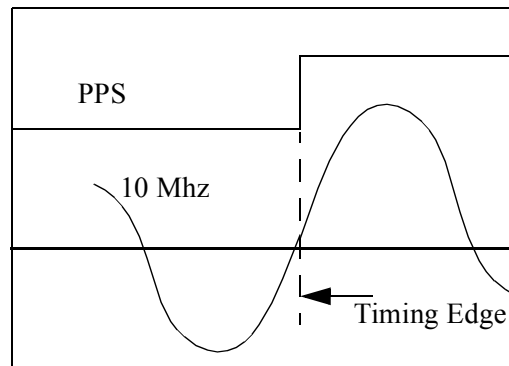
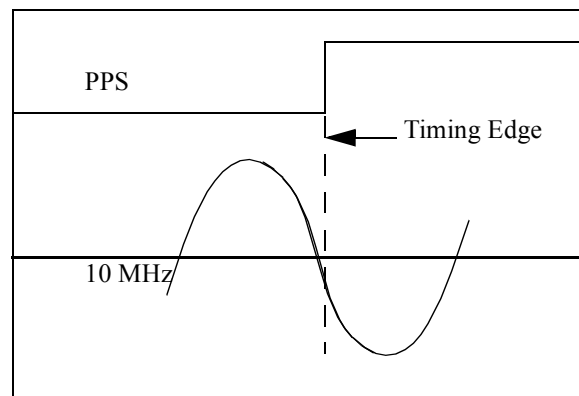
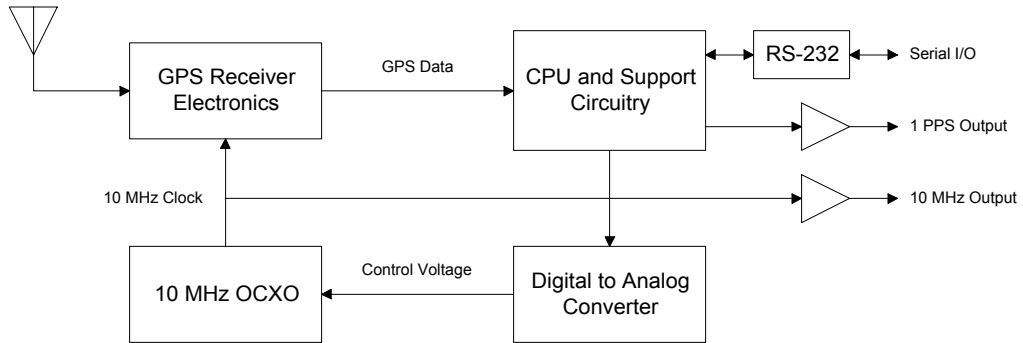

Figure 5-8 10 MHz with positive zero crossing (shown with rising edge)**Figure 5-9 10 MHz with negative zero crossing (shown with rising edge)**

The PPS is generated from the 10 MHz and the rising edge will match the zero crossing within 10 nanoseconds. When the PPS is adjusted using the cable delay command, the phase of the 10 MHz will move by the same amount so that the rising edge of the PPS always corresponds to the zero crossing of the 10 MHz.

5.3.2 System Architecture

Figure 5-10 ThunderBolt System Architecture



A Trimble Standard Interface Protocol for ThunderBolt

The Trimble Standard Interface Protocol (TSIP) may be characterized as a set of data packets used to transmit information to and receive information from a Trimble GPS receiver. Trimble products commonly support a version of TSIP that is customized to the attributes of the product; this appendix describes the ThunderBolt customization. Many TSIP data packets are common to all products that use TSIP. An example would be a single precision position output packet. Other packets are unique to a product. An example of a unique ThunderBolt packet is a packet designed to allow the control and monitoring of an oven oscillator. Custom packets are only used in the products for which they have been created.

TSIP is a powerful and compact interface protocol that has been designed to allow the system developer a great deal of flexibility in interfacing to a Trimble product. This appendix has been generated and reviewed with care, however, history has shown that it is surprisingly difficult to generate a TSIP appendix that is entirely free of errors. There is no reason to believe that this appendix will be an exception. Trimble is always grateful to receive reports of any errors in either products or documentation.

A.1 Interface Scope

The ThunderBolt GPS module has one configurable serial communication port, which is a bi-directional control and data port utilizing the Trimble Standard Interface Protocol (TSIP). The data I/O port characteristics and other parameters are user *programmable* and *stored* in non-volatile memory (EEPROM.)

The TSIP protocol is based on the transmission of packets of information between the user equipment and the GPS receiver. Each packet includes an identification code that identifies the meaning and format of the data that follows. Each packet begins and ends with control characters. For details, see section A.8.

The TBOLTCHT (ThunderBolt Chat) utility, part of the ThunderBolt Tool Kit, was created to exercise a commonly used subset of the ThunderBolt TSIP packets. The TBOLTCHT source code that is provided with the ThunderBolt starter kit is an excellent guide for embedded software designers to use as a reference for developing the ThunderBolt interface code.

A.2 Automatic Output Packets

In its default configuration, the ThunderBolt GPS disciplined clock sends packets 0x8F-AB and 0x8F-AC once per second while operating in a time-only fix mode (e.g. Over-Determined Clock mode.) While operating in a position fix mode (e.g. while performing a self-survey,) the ThunderBolt also sends packets 0x42 (XYZ position) and 0x43 (ECEF velocity.) For most system implementations these output packets provide all of the information required for operation including time, position, GPS status, and health. Table A-1 lists all of the packets that can be configured for automatic output. The Masking Packet ID column lists the command packet that controls the automatic output of these packets. To reduce serial port traffic, the user can disable all of the automatic output packets and then request packets only when needed.

Table A-1 Automatic Output Packets

Output Packet ID	Description	Masking Packet ID	Request Packet ID	When Sent
0x42	Position XYZ (ECEF), single precision	0x35	0x37	When a position fix is computed
0x43	Velocity XYZ, single precision	0x35	0x37	When a position fix is computed
0x4A	Position LLA, single precision	0x35	0x37	When a position fix is computed
0x56	Velocity ENU, single precision	0x35	0x37	When a position fix is computed
0x58	Satellite system data (almanac, UTC info, ephemeris, ionosphere info, SV health)	0x8E-A5	0x38	When new system data is received
0x5B	Satellite ephemeris status	0x8E-A5	0x3B	When a new ephemeris is received
0x6D	Satellite selection list, DOPS, fix mode	0x8E-A5	0x24	When the satellite selection list is updated
0x83	Position XYZ (ECEF), double precision	0x35	0x37	When a position fix is computed
0x84	Position LLA, double precision	0x35	0x37	When a position fix is computed
0x8F-A7	Individual satellite solutions	0x8E-A5	None	Once per second
0x8F-AB	Primary timing packet	0x8E-A5	0x8E-AB	Once per second
0x8F-AC	Supplemental timing packet	0x8E-A5	0x8E-AC	Once per second

A.3 Customizing ThunderBolt Operations

The ThunderBolt provides a number of user configurable parameters that allow the user to customize the operation of the ThunderBolt. These parameters are stored in a non-volatile memory chip (EEPROM) to be retained during loss of power and through resets. At reset or power-up, the ThunderBolt configures itself based on the parameters stored in the EEPROM. The user can change the values of these parameters to achieve the desired operations using a variety of TSIP packets. The ThunderBolt configures itself based on the new parameter immediately, but the new parameter value is not automatically saved to the EEPROM. The user must direct the ThunderBolt to save the parameters to the EEPROM.

Parameters are grouped into sections of the EEPROM called segments. Each segment is identified with a number and contains a group of related parameters. To change the parameter values stored in EEPROM, the user sends packet 0x8E-4C to direct the ThunderBolt to save the current parameter values in a specified segment in the EEPROM. The user can also direct the ThunderBolt to set the parameter values to their factory default settings with packet 0x8E-45. When a segment is set to its factory defaults, the contents of the EEPROM segment are set and the ThunderBolt configures itself with the default settings.

In brief, to customize the ThunderBolt operations for your application:

- Configure the ThunderBolt using TSIP command packets until the desired operation is achieved.
- Use TSIP packet 0x8E-4C to save the settings in non-volatile memory (EEPROM.)

The new settings will control ThunderBolt operations whenever it is reset or power cycled.

The following tables list the user configurable parameters by segment number. Each table lists the parameter name, its factory default value, and the TSIP packet that sets or reads the parameter value (typically, one TSIP packet sets or reads several related parameters.)

Table A-2 Receiver Configuration - Segment 3

Parameter	Factory Default	Set	Request	Report
receiver mode	4 (Full Position 3D)	0xBB	0xBB	0xBB
dynamics code	1 (land)			
elevation mask	0.175 radians (10 deg)			
signal level mask	4 (AMU)			
PDOP mask	8			
PDOP switch	6			
foliage mode	1 (sometimes)			

Table A-3 Packet I/O Control - Segment 4

Parameter	Factory Default	Set	Request	Report
Packet broadcast mask mask 0 mask 1	0x05 0x00	0x8E-A5	0x8E-A5	0x8E-A5
Packet 0x35 data position (byte 0) velocity (byte 1) timing (byte 2) auxiliary (byte 3)	0x01 0x01 0x00 0x00	0x35	0x35	0x35
Datum	0 (WGS-84)	0x8E-15	0x8E-15	0x8F-15

Table A-4 Serial Port Configuration - Segment 5

Parameter	Factory Default	Set	Request	Report
Input baud rate	7 (9600 baud)	0xBC	0xBC	0xBC
Output baud rate	7 (9600 baud)			
Data bits	8			
Parity	0 (none)			
Stop bits	1			
Input protocol	2 (TSIP)			
Output protocol	2 (TSIP)			

Table A-5 Timing Outputs - Segment 6

Parameter	Factory Default	Set	Request	Report
PPS enable	1 (enabled)	0x8E-4A	0x8E-4A	0x8F-4A
PPS sense	1 (rising edge)			
PPS offset	0.0 (seconds)			
Bias Uncertainty Threshold	300.0 (meters)	0x8E-4A	0x8E-4A	0x8F-4A
10 MHz sense	1 (rising edge)	0x8E-A1	0x8E-A1	0x8F-A1
UTC/GPS timing	0 (GPS timing)	0x8E-A2	0x8E-A2	0x8F-A2

Table A-6 Accurate Position - Segment 7

Parameter	Factory Default	Set	Request	Report
Position	No stored position	0x31, 0x32	0x8E-AC	0x8F-AC

Table A-7 Self-Survey - Segment 8

Parameter	Factory Default	Set	Request	Report
Self-survey enable	1 (enabled)	0x8E-A9	0x8E-A9	0x8F-A9
Position save flag	0 (don't save)			
Self-survey count	2000 (fixes)			

Table A-8 Oscillator Disciplining - Segment 9

Parameter	Factory Default	Set	Request	Report
Time constant	100 (seconds)	0x8E-A8	0x8E-A8	0x8F-A8
Loop damping	1.2			
OCXO gain	-5.0 (Hz/volt)			
Min. control voltage	-5.0 (volts)			
Max. control voltage	5.0 (volts)			
Initial DAC voltage	0.0 (volts)			
Recovery mode jam sync threshold	300.0 (ns)			
Recovery mode max frequency offset	50.0 (ppb)			

A.4 Packets Output at Power-Up

After completing its self-diagnostics, the ThunderBolt automatically outputs the following packet.

Table A-9 Packets Output at Power-up

Output Packet ID	Description
0x45	software version info

A.5 Changes to ThunderBolt Firmware

This manual represents firmware shipped after February 1998. Units shipped before that time may have an earlier version of the firmware. This section describes some of the packets that are obsolete and their replacements.

Table A-10 Obsolete Packets

Packet ID	Packet Description	Replacement ID
0x22	Position fix mode select	0xBB
0x23	Set initial position (XYZ ECEF)	0x31
0x2A	Set initial position (lat, long, alt)	0x32
0x3D	Set port configuration	0xBC
0x41	Report GPS time	0x8F-AB
0x8F-0B	Timing superpacket	0x8F-AB & 0x8F-AC
0x8F-20	Last fix and extra information	Various

A.6 Report Packets: ThunderBolt to User

The table below summarizes the packets output by the ThunderBolt. The table includes the output packet ID, a short description of each packet, and the associated input packet. In some cases, the response packets depend on user-selected options.

Table A-11 Report Packets

Output ID	Packet Description	Input ID
0x42	Single-precision XYZ position	0x37, auto
0x43	Velocity fix (XYZ ECEF)	0x37, auto
0x45	Software version information	0x1F, 0x1E, 0x25
0x47	Signal level for all satellites	0x27
0x49	Almanac health page	0x29
0x4A	Single-precision LLA position	0x37, auto
0x55	I/O packet options	0x35
0x56	Velocity fix (ENU)	0x37, auto
0x57	Information about the last computed fix	0x37
0x58	GPS system data	0x38, auto
0x59	Satellite enable/disable & health flag	0x39
0x5A	Raw measurement data	0x3A
0x5B	Satellite ephemeris status	0x3B
0x5C	Satellite tracking status	0x3C
0x5F-11	EEPROM segment status	0x3F-11
0x6D	Satellite selection list	0x24, auto
0x70	Filter configuration	0x70
0x83	Double-precision XYZ position	0x37, auto
0x84	Double-precision LLA position	0x37, auto
0xBB	GPS receiver configuration	0xBB
0xBC	Serial port configuration	0xBC
0x8F-15	Datum values	0x8E-15
0x8F-41	Manufacturing parameters	0x8E-41
0x8F-42	Production parameters	0x8E-42
0x8F-45	Revert segment(s) to factory default values	0x8E-45
0x8F-4A	PPS characteristics	0x8E-4A
0x8F-4C	Save segment(s) to EEPROM	0x8E-4C
0x8F-A0	DAC value	0x8E-A0
0x8F-A1	10 MHz sense	0x8E-A1
0x8F-A2	UTC/GPS timing	0x8E-A2
0x8F-A3	Disciplining command	0x8E-A3
0x8F-A4	Test modes	0x8E-A4
0x8F-A5	Packet broadcast mask	0x8E-A5

Table A-11 Report Packets (Continued)

0x8F-A6	Self-survey command	0x8E-A6
0x8F-A7	Individual satellite solutions	Auto
0x8F-A8	Disciplining parameters	0x8E-A8
0x8F-A9	Self-survey parameters	0x8E-A9
0x8F-AB	Primary timing packet	0x8E-AB, auto
0x8F-AC	Secondary timing packet	0x8E-AC, auto

A.7 Command Packets: User to ThunderBolt

The table below summarizes the packets that can be input by the user. The table includes the input packet ID, a short description of each packet, and the associated output packet.

Table A-12 Command Packets

Input ID	Packet Description	Output ID
0x1E	Initiate cold reset or factory reset	0x45
0x1F	Request software version information	0x45
0x24	Request GPS satellite selection list	0x6D
0x25	Initiate warm reset & self-test	0x45
0x27	Request signal levels	0x47
0x29	Request almanac health page	0x49
0x31	Set accurate initial position (XYZ ECEF)	--
0x32	Set accurate initial position (lat, long, Alt)	--
0x34	Set satellite selection for one-satellite mode	--
0x35	Set/Request I/O options	0x55
0x37	Request status and values of last position and velocity	0x57 (and other enabled packets)
0x38	Request satellite system data	0x58
0x39	Set/Request satellite disable or ignore health	0x59
0x3A	Request last raw measurement	0x5A
0x3B	Request current status of SV ephemeris data	0x5B
0x3C	Request current satellite tracking status	0x5C
0x3F-11	Request EEPROM segment status	0x5F-11
0x70	Set/Request position filter enable/disable	0x70
0xBB	Set/Request GPS receiver configuration	0xBB
0xBC	Set/Request serial port configuration	0xBB
0x8E-15	Set/Request current datum	0x8F-15
0x8E-41	Request manufacturing parameters	0x8F-41
0x8E-42	Request production parameters	0x8F-42
0x8E-45	Revert to default settings	0x8F-45

Table A-12 Command Packets (Continued)

0x8E-4A	Set/Request PPS characteristics	0x8F-4A
0x8E-4C	Save segments to EEPROM	0x8F-4C
0x8E-A0	Set/Request DAC values	0x8F-A0
0x8E-A1	Set/Request 10 MHz sense	0x8F-A1
0x8E-A2	Set/Request UTC/GPS timing mode	0x8F-A2
0x8E-A3	Issue Disciplining Command	0x8F-A3
0x8E-A4	Setup a test mode	0x8F-A4
0x8E-A5	Set/Request packet broadcast mask	0x8F-A5
0x8E-A6	Issue self-survey command	0x8F-A6
0x8E-A8	Set/Request disciplining parameters	0x8F-A8
0x8E-A9	Set/Request self-survey parameters	0x8F-A9
0x8E-AB	Request primary timing packet	0x8F-AB
0x8E-AC	Request supplemental timing packet	0x8F-AC

A.8 Packet Structure

TSIP packet structure is the same for both commands and reports. The packet format is:

```
<DLE> <id> <data string bytes> <DLE> <ETX>
```

Where:

- <DLE> is the byte 0x10
- <ETX> is the byte 0x03
- <id> is a packet identifier byte, which can have any value excepting <ETX> and <DLE>.

The bytes in the data string can have any value. To prevent confusion with the frame sequences <DLE> <id> and <DLE> <ETX>, every <DLE> byte in the data string is preceded by an extra <DLE> byte ('stuffing'). These extra <DLE> bytes must be added ('stuffed') before sending a packet and removed after receiving the packet. Notice that a simple <DLE> <ETX> sequence does not necessarily signify the end of the packet, as these can be bytes in the middle of a data string. The end of a packet is <ETX> preceded by an odd number of <DLE> bytes.

Multiple-byte numbers (integer, float, and double) follow the ANSI / IEEE Std. 754 IEEE Standard for binary Floating-Point Arithmetic. They are sent most-significant byte first. Note that switching the byte order will be required in Intel-based machines. The data types used in the ThunderBolt TSIP are defined below.

- UINT8 - An 8 bit unsigned integer (0 to 255).
- SINT8 - An 8 bit signed integer (-128 to 127).
- INT16 - A 16 bit unsigned integer (0 to 65,535).
- SINT16 - A 16 bit signed integer (-32,768 to 32,767).

- UINT32 - A 32 bit unsigned integer (0 to 4,294,967,295)
- SINT32 - A 32 bit signed integer (-2,147,483,648 to 2,147,483,647).
- Single — Float (4 bytes) (3.4x10⁻³⁸ to 1.7x10³⁸) (24 bit precision)
- Double — Float (8 bytes) (1.7x10⁻³⁰⁸ to 3.4x10³⁰⁸) (53 bit precision)



Note – Default serial port settings are: 9600, 8-none-1

A.9 Packet Descriptions

A.9.1 Command Packet 0x1E Initiate Cold or Factory Reset

This packet commands the ThunderBolt to perform either a cold reset or a factory reset. A cold reset will clear the GPS data (almanac, ephemeris, etc.) stored in RAM and is equivalent to a power cycle. A factory reset will additionally restore the factory defaults of all configuration parameters stored in non-volatile memory (EEPROM.) This packet contains one data byte equal to the ASCII letter 'K' or 'F'. The data format is shown below.

Table A-13 Command Packet 0x1E Data Format

Byte	Item	Type	Value	Meaning
0	Reset	UINT8	'K' (0x4B) 'F' (0x46)	cold reset factory reset



Caution – The factory reset command will delete the stored position and will cause self-survey to restart.

A.9.2 Command Packet 0x1F Request Software Version

This packet requests information about the version of software in the ThunderBolt. This packet contains no data. The GPS receiver returns packet 0x45.

A.9.3 Command Packet 0x20 Request Almanac

This packet requests almanac data for one satellite. The packet contains one data byte specifying the PRN number of the selected satellite. The GPS receiver returns packet 0x40.

A.9.4 Command Packet 0x24 Request GPS Satellite Selection List

This packet requests a list of satellites used for the current position/time fix. This packet contains no data. The GPS receiver returns packet 0x6D.

A.9.5 Command Packet 0x25 Initiate Warm Reset & Self Test

This packet commands the GPS receiver to perform a warm reset. This is not equivalent to cycling the power because the ThunderBolt retains the GPS data (almanac, ephemeris, etc.) it has collected and stored in RAM. The GPS receiver performs a self-test as part of the reset operation. This packet contains no data. Following completion of the reset, the receiver will output the start-up messages (see Table .)

A.9.6 Command Packet 0x27 - Request Signal Levels

This packet requests signal levels for all satellites currently being tracked. This packet contains no data. The GPS receiver returns packet 0x47.

A.9.7 Command Packet 0x29 - Request Almanac Health Page

This packet requests the GPS receiver to send the health page from the almanac. This packet contains no data. The GPS receiver returns packet 0x49.

A.9.8 Command Packet 0x31 Set Accurate Initial Position (XYZ Cartesian ECEF)

This packet provides an accurate initial position to the GPS receiver in XYZ coordinates. The GPS receiver uses this position for performing time-only fixes. If a survey is in progress when this command is sent, the survey is aborted, the packet position data is used immediately, and the ThunderBolt switches to Over-Determined Clock Mode.

Table A-14 Command Packet 0x31 Data Format <<segment 7>>

Byte	Item	Type	Units
0-3	X-axis	Single	Meters
4-7	Y-axis	Single	Meters
8-11	Z-axis	Single	Meters

A.9.9 Command Packet 0x32 Set Accurate Initial Position (Latitude, Longitude, Altitude)

This packet provides an accurate initial position to the GPS receiver in latitude, longitude, and altitude coordinates. The GPS receiver uses this position for performing time-only fixes. If a survey is in progress when this command is issued, the survey is aborted, the packet position data is used immediately, and the ThunderBolt switches to Over-Determined Clock Mode. The coordinates entered must be in the current datum. See packet 8E-15 for setting the datum or use the default WGS-84 datum.

Table A-15 Command Packet 0x32 Data Format <<segment 7>>

Byte	Item	Type	Units
0-3	Latitude	Single	Radians, north
4-7	Longitude	Single	Radians, east
8-11	Altitude	Single	Meters

A.9.10 Command Packet 0x34 – Set Satellite Selection For One-Satellite Mode

This packet allows the user to control the choice of the satellite to be used for the one-satellite time-only fix mode. This packet contains one byte. If the byte value is 0, the GPS receiver chooses the usable satellite with the highest elevation above the horizon. This automatic selection of the highest satellite is the default action, and the GPS receiver does this unless it receives this packet. If the byte value is from 1 to 32, the packet specifies the PRN number of the satellite to be used.

A.9.11 Command Packet 0x35 Set or Request I/O Options

This packet requests the current I/O option states and allows the I/O option states to be set as desired.

To request the option states without changing them, the user sends this packet with no data bytes. To change any option states, the user includes 4 data bytes as shown in the table below. The I/O options, their default states, and the byte values for all possible states are shown below. These option states can be set into non-volatile memory (EEPROM) with the 0x8E-4C command. The GPS receiver returns packet 0x55. See section A.3 for information on saving the settings to non-volatile memory.

These abbreviations apply to the following table: ALT (Altitude), ECEF (Earth-centered, Earth-fixed), XYZ (Cartesian coordinates), LLA (latitude, longitude, altitude), HAE (height above ellipsoid), WGS-84 (Earth model (ellipsoid)), MSL geoid (mean sea level), and UTC (universal coordinated time).

Table A-16 Command Packet 0x35 Date Format << segment 3>>

Byte	Data Type	Bit	Default	Value	Meaning	Associated Packet
0	Position	0	1	0 1	ECEF off ECEF on	0x42 or 0x83
		1	0	0 1	LLA off LLA on	0x4A or 0x84
		2	0	0 1	HAE (datum) MSL geoid	0x4A or 0x84
		3	0	0	reserved	
		4	0	0 1	single-precision position double-precision position	0x42/4A 0x83/84
		5:7	0		reserved	
1	Velocity	0	1	0 1	ECEF off ECEF on	0x43
		1	0	0 1	ENU off ENU on	0x56
		2:7	0		reserved	
2	Timing	0	0	0 1	GPS time reference UTC time reference	0x42, 0x43, 0x4A, 0x83, 0x84, 0x56,
		3	Auxiliary	0	0	0 1
		1	0	0 1	raw PR's in 5A filtered PR's in 5A	0x5A
		2	Reserved			
		3	0	0 1	output AMU output dB/Hz	0x5A, 0x5C, 0x47
		4:7	Reserved	0	0	

A.9.12 Command Packet 0x37 Request Status and Values of Last Position

This packet requests information regarding the last position fix (normally used when the GPS receiver is not automatically outputting fixes). The GPS receiver returns the position/velocity auto packets specified in the 0x35 message as well as message 0x57. This packet contains no data.

A.9.13 Command Packet 0x38 Request Satellite System Data

This packet requests current satellite data. The GPS receiver returns packet 0x58.

Table A-17 Command Packet 0x38 Data Format

Byte	Item	Type	Value	Meaning
0	Operation	UINT8	1	must always be '1'
1	Type of data	UINT8	1 2 3 4 5 6	Not used Almanac Health page, t_{oa} , WN_a Ionosphere UTC Ephemeris
2	Sat PRN#	UINT8	0 1 - 32	Data not satellite ID specific satellite PRN number

A.9.14 Command Packet 0x39 Set or Request SV Disable and Health Use

Normally the GPS receiver selects only healthy satellites (based on transmitted values in the ephemeris and almanac) which satisfy all mask values. This packet allows overriding the internal logic and forces the receiver to either unconditionally disable a particular satellite or to ignore a bad health flag. The GPS receiver returns packet 0x59 if operation 3 or 6 is requested; otherwise there is no reply.

It should be noted that when viewing the satellite disables list, the satellites are not numbered but are in numerical order. The disabled satellites are signified by a "1" and enabled satellites are signified by a "0".

Table A-18 Command Packet 0x39 Data Format

Byte	Item	Type	Value	Meaning
0	Operation	UINT8	1 2 3 4 5 6	Enable satellite (default) Disable satellite Request enable/disable status of all 32 satellites Heed health (default) Ignore health Request heed - or - ignore health on all 32 satellites
1	Satellite #	UINT8	0 1 - 32	All 32 satellites Any one satellite PRN number



Note – At power-on and after a reset the default values are set for all satellites.



Caution – Ignoring health can cause the GPS receiver software to lock up, as an unhealthy satellite may contain defective data. Use extreme caution in ignoring satellite health.

A.9.15 Command Packet 0x3A Request Last Raw Measurement

This packet requests the most recent raw measurement data for one specified satellite. The GPS receiver returns packet 0x5A if data is available.

Table A-19 Command Packet 0x3A Data Format

Byte	Item	Type	Value	Meaning
0	Satellite number	INT8	0 1-32	all satellites in current tracking set specific desired satellite

A.9.16 Command Packet 0x3B Request Current Status of Ephemeris Data

This packet requests the current status of satellite ephemeris data. The GPS receiver returns packet 0x5B if data is available.

A.9.17 Command Packet 0x3C Request Current Satellite Tracking Status

This packet requests the current satellite tracking status. The GPS receiver returns packet 0x5C if data is available.

Table A-20 Command Packet 0x3C Data Format

Byte	Item	Type	Value	Meaning
0	Satellite number	INT8	0 1-32	all satellites in current tracking set specific desired satellite

A.9.18 Command Packet 0x3F-11 Request EEPROM Segment Status

Use command packet 0x3F-11 to requests the status of the EEPROM segments and to clear the EEPROM status minor alarm bit (bit 10) in the supplemental timing packet 0x8F-AC. The ThunderBolt replies with report packet 0x5F-11.

A.9.19 Report Packet 0x42 Single-precision Position Fix

This packet provides current GPS position fix in XYZ ECEF coordinates. If the I/O “position” option is set to "XYZ ECEF" and the I/O "Precision-of-Position output" is set to single-precision, then the GPS receiver sends this packet each time a fix is computed or in response to packet 0x37. The data format is shown below.

Table A-21 Report Packet 0x42 Data Format

Byte	Item	Type	Units
0-3	X	Single	meters
4-7	Y	Single	meters
8-11	Z	Single	meters
12-15	time-of-fix	Single	seconds

The time-of-fix is in GPS time or UTC as selected by the I/O “timing” option in packet 0x35. Packet 0x83 provides a double-precision version of this information.

A.9.20 Report Packet 0x43 Velocity Fix, XYZ ECEF

This packet provides current GPS velocity fix in XYZ ECEF (Earth-Centered Earth-Fixed) coordinates. If the I/O “velocity” option (packet 0x35) is set to “XYZ ECEF”, then the GPS receiver sends this packet each time a fix is computed or in response to packet 0x37. The data format is shown below. The time-of-fix is in GPS time or UTC as selected by the I/O “timing” option.

Table A-22 Report Packet 0x43 Data Format

Byte	Item	Type	Units
0-3	X velocity	Single	meters/second
4-7	Y velocity	Single	meters/second
8-11	Z velocity	Single	meters/second
12-15	bias rate	Single	meters/second
16-19	time-of-fix	Single	Seconds

A.9.21 Report Packet 0x45 Software Version Information

This packet provides information about the version of software in the ThunderBolt. The GPS receiver sends this packet after power-on and resets and in response to packet 0x1F.

Table A-23 Report Packet 0x45 Data Format

Byte	Item	Type
0	Application layer major version number	UINT8
1	Application layer minor version number	UINT8
2	Month	UINT8
3	Day	UINT8
4	Year number minus 1900	UINT8
5	GPS core layer major revision number	UINT8
6	GPS core layer minor revision number	UINT8
7	Month	UINT8
8	Day	UINT8
9	Year number minus 1900	UINT8

A.9.22 Report Packet 0x47 Signal Level for All Satellites Tracked

This packet provides received signal levels for all satellites currently being tracked or on which tracking is being attempted (i.e., above the elevation mask and healthy according to the almanac). The receiver sends this packet only in response to packet 0x27. The data format is shown below. Up to 8 satellite number/signal level pairs may be sent, indicated by the count field. Signal level is normally positive. If it is zero then that satellite has not yet been acquired. If it is negative then that satellite is not currently in lock. The absolute value of signal level field is the last known signal level of that satellite. The signal level provided in this packet is a measure of the signal strength after correlation or de-spreading. Units are either AMU or dB/Hz as controlled by packet 0x35.

Table A-24 Report Packet 0x47 Data Format

Byte	Item	Type
0	Count	UINT8
1	satellite number 1	UINT8
2- 5	signal level 1	Single
6	satellite number 2	UINT8
7-10	signal level 2	Single
(etc.)	(etc.)	(etc.)

A.9.23 Report Packet 0x49 - Almanac Health Page

This packet provides health information on 32 satellites. Packet data consists of 32 bytes each containing the 6-bit health from almanac page 25. The first byte is for satellite #1, and so on. The receiver sends this packet in response to packet 0x29.

Table A-25 Report Packet 0x49 Data Format

Byte	Item
0	Health of satellite #1
1	Health of satellite #2
.	.
.	.
.	.
31	Health of satellite #32

A.9.24 Report Packet 0x4A Single Precision LLA Position Fix

The packet provides current GPS position fix in LLA (latitude, longitude, and altitude) coordinates. If the I/O position option is set to “LLA” and the I/O precision of position output is set to single precision, then the receiver sends this packet each time a fix is computed or in response to packet 0x37. The data format is shown below:

Table A-26 Report Packet 0x4A Single Precision LLA Position Fix

Byte	Item	Type	Units
0-3	latitude	Single	Radians: + for north, - for south
4-7	longitude	Single	Radians: + for east, - for west
8-11	altitude	Single	Meters
12-15	clock bias	Single	Meters (always relative to GPS)
16-19	time of fix	Single	Seconds

The LLA conversion is done according to the datum selected using packet 8E-15. The default is WGS-84. Altitude is referred to the datum or the MSL Geoid, depending on which LLA altitude option is selected with packet 0x35. The time of fix is in GPS time or UTC, depending on which I/O timing option is selected with packet 0x35.



Caution – When converting from radians to degrees, significant and readily visible errors will be introduced by use of an insufficiently precise approximation for the constant π (ρ). The value of a constant π as specified in ICD-GPS-200 is 3.1415926535898.



Caution – The MSL option is only valid with the WGS-84 datum. When using other datums, only the HAE option is valid.

A.9.25 Report Packet 0x55 I/O Options

This packet provides the current I/O option states in response to packet 0x35 requests. The data format is the same as for packet 0x35 and is repeated below for convenience.

These abbreviations apply to the following table: ALT (Altitude), ECEF (Earth-centered, Earth-fixed), XYZ (Cartesian coordinates), LLA (latitude, longitude, altitude), HAE (height above ellipsoid), WGS-84 (Earth model (ellipsoid)), MSL geoid (Earth (mean sea level) mode), and UTC (coordinated universal time).

Table A-27 Report Packet 0x55 Date Format << segment 3>>

Byte	Data Type	Bit	Default	Value	Meaning	Associated Packet
0	Position	0	1	0 1	ECEF off ECEF on	0x42 or 0x83
		1	0	0 1	LLA off LLA on	0x4A or 0x84
		2	0	0 1	HAE (datum) MSL geoid	0x4A or 0x84
		3	0	0	reserved	
		4	0	0 1	single-precision position double-precision position	0x42/4A 0x83/84
		5:7	0		reserved	
1	Velocity	0	1	0 1	ECEF off ECEF on	0x43
		1	0	0 1	ENU off ENU on	0x56
		2:7	0		reserved	
2	Timing	0	0	0 1	GPS time reference UTC time reference	0x42, 0x43, 0x4A, 0x83, 0x84, 0x56,
3	Auxiliary	0	0	0 1	packet 5A off packet 5A on	0x5A
		1	0	0 1	raw PR's in 5A filtered PR's in 5A	0x5A
		2	Reserved			
		3	0	0 1	output AMU output dB/ Hz	0x5A, 0x5C, 0x47
		4:7	Reserved	0	0	

A.9.26 Report Packet 0x56 Velocity Fix, East-North-Up (ENU)

If East-North-Up (ENU) coordinates have been selected for the I/O “velocity” option, the receiver sends this packet each time a fix is computed or in response to packet 0x37. The data format is shown below. The time-of-fix is in GPS or UTC time as selected by the I/O “timing” option.

Table A-28 Report Packet 0x56 Data Format

Byte	Item	Type	Units
0-3	east velocity	Single	m/s; + for east, - for west
4-7	north velocity	Single	m/s; + for north, - for south
8-11	up velocity	Single	m/s; + for up, - for down
12-15	clock bias rate	Single	m/s
16-19	time-of-fix	Single	seconds

A.9.27 Report Packet 0x57 Information about Last Computed Fix

This packet provides information concerning the time and origin of the previous position fix. The receiver sends this packet, among others, in response to packet 0x37. The data format is shown below.

Table A-29 Report Packet 0x57 Data Format

Byte	Item	Type	Value	Meaning
0	source of info	UINT8	0	none
			1	regular fix
			2	initialization diagnostic
			4	initialization diagnostic
			5	entered by 0x23 or 0x2B
			6	entered by 0x31 or 0x32
			8	default after BBRAM fail
			1	tracking mode
1	time only 1-SV			
2	2D clock hold			
3	2D			
4	3D			
5	overdetermined clock			
6	DGPS reference			
2-5	time of last fix	Single		seconds GPS time
6-7	week of last fix	UINT16		weeks

A.9.28 Report Packet 0x58 GPS System Data from Receiver

This packet provides GPS data (almanac, ephemeris, etc.). If enabled with packet 0x8E-A5, the ThunderBolt automatically sends this packet when new data is received, otherwise this packet is sent in response to a request for data using packet 0x38. The data format is shown below. If data is not available, byte 3 is set to 0 and "no" data is sent. All angles are in radians.



Note – Reference numbers refer to “Global Positioning System Standard Positioning Service Signal Specification.” This document is available in Adobe Acrobat format at <http://www.navcen.uscg.gov>

Table A-30 Report Packet 0x58 Data Format

Byte	Item	Type	Value	Meaning
0	Operation	UINT8	2	data out
			3	no data on SV
1	Type of data	UINT8	2	Almanac
			3	Health page, T _{oa} , WN _{oa}
			4	Ionosphere
			5	UTC
			6	Ephemeris
2	Sat PRN #	UINT8	0	Data that is not satellite ID-specific
			1 to 32	Satellite PRN number
3	Length (n)	UINT8		Byte count
4 to n+3	Data			

Table A-31 Report Packet 0x58 Data Format

Byte	Item	Type	Meaning
4	T _{oa} (raw)	Single	Table 2.8
5	SV_HEALTH	Single	
6-9	E	Single	
10-13	t _{oa}	Single	
14-17	i _o	Single	
18-21	OMEGADOT	Single	
22-25	A	Single	
26-29	(OMEGA) ₀	Single	
30-33	()	Single	
34-37	M ₀	Single	
38-41	a _{f0}	Single	

Table A-31 Report Packet 0x58 Data Format (Continued)

42-45	a_{f1}	Single	
46-49	A	Single	
50-53	n	Single	
54-57	OMEGA_n	Single	derived
58-61	ODOT_n	Single	derived
62-65	t_{zc}	Single	time of collection (set to -1.0 if there is no data available)
66-67	week number	UINT16	GPS week number
68-69	WN _a	UINT16	Sec 2.4.5.2.3

Table A-32 Report Packet 0x58 Almanac Health Data (Type 3)

Byte	Item	Type	Meaning
4	week number for health	UINT8	Sec 2.4.5.3
5-36	SV health	UINT8	Sec 2.4.5.3
37	t_{oa} for health	UINT8	Sec 2.4.5.2.3
38	current t_{oa}	UINT8	time of collection
39-40	current week number	UINT16	time of collection

Table A-33 Report Packet 0x58 Ionosphere Data (Type 4)

Byte	Item	Type	Meaning
4-11	not used		
12-15	I_0	Single	Sec 2.4.5.6
16-19	I_1	Single	
20-23	I_2	Single	
24-27	I_3	Single	
28-31	J_0	Single	
32-35	J_1	Single	
36-39	J_2	Single	
40-43	J_3	Single	

Table A-34 Report Packet 0x58 UTC Data (Type 5)

Byte	Item	Type	Meaning
4-16	not used		
17-24	A_0	Double	Sec 2.4.5.5
25-28	A_1	Single	
29-30	$-t_{LS}$	SINT16	
31-34	t_{ot}	Single	
35-36	WN_t	UINT16	
37-38	WN_{LSF}	UINT16	
39-40	DN	UINT16	
41-42	$-t_{LSf}$	SINT16	

Table A-35 Report Packet 0x58 Ephemeris Data (Type 6)

Byte	Item	Type	Meaning
4	SV number	UINT8	SV PRN number
5-8	t_{ephem}	Single	time of collection (seconds)
9-10	week number	Integer	GPS week number 0 thru 1023
11	retired		
12	retired		
13	SV accuracy raw	UINT8	URA index of SV (0 thru 15)
14	SV health	UINT8	6 bit health code
15-16	IODC	UINT16	Issue of data clock
17-20	t_{GD}	Single	L1-L2 correction term
21-24	t_{oc}	Single	Sec 2.4.3.6
25-28	a_{f2}	Single	Sec 2.4.3.6
29-32	a_{f1}	Single	
33-36	a_{fo}	Single	
37-40	SV accuracy	Single	URA of SV
41	IODE	UINT8	issue of data ephemeris
42	retired		Table 2-4
43-46	C_{rs}	Single	
47-50	-n	Single	
51-58	M_0	Double	

Table A-35 Report Packet 0x58 Ephemeris Data (Type 6) (Continued)

59-62	C _{uc}	Single	Table 2-5
63-70	e	Double	
71-74	C _{US}	Single	
75-82	A	Double	
83-86	t _{oe}	Single	
87-90	C _{ic}	Single	
91-98	(OMEGA) ₀	Double	
99-102	C _{is}	Single	
103-110	i _o	Double	
111-114	C _{rc}	Single	
115-122	()	Double	
123-126	OMEGADOT	Single	
127-130	IDOT	Single	
131-138	A ²	Double	
139-146	n	Double	
147-154	r1me2	Double	= sqrt(1.0-e ²)
155-162	OMEGA_n	Double	derived from OMEGA_0, OMEGADOT
163-170	ODOT_n	Double	derived from OMEGADOT

A.9.29 Report Packet 0x59 Status of Satellite Disable or Ignore Health

This packet is sent in response to command packet 0x39.

Table A-36 Report Packet 0x59 Data Format

Byte	Item	Type	Value	Meaning
0	Operation	UINT8	3	The remaining bytes tell whether receiver is allowed to select each satellite.
			6	The remaining bytes tell whether the receiver heeds or ignores each satellite's health as a criterion for selection.
1 to 32	Satellite #	UINT8 (1 per SV)	0 1	(Enable satellite selection or heed satellite's health. Default value. Disable satellite selection or ignore satellite's health.

A.9.30 Report Packet 0x5A Raw Measurement Data

Packet 0x5A provides raw GPS measurement data. If the packet 0x35 auxiliary option byte bit 1 is set, this packet is sent automatically as measurements are taken. In the table below, the sample length is the number of milliseconds over which the sample was averaged. The code phase value is the average delay over the sample interval of the received C/A code, and is measured with respect to the receiver's millisecond timing reference.

Table A-37 Report Packet 0x5A Data Format

Byte	Item	Type	Units
0	SV PRN number	UINT8	
1-4	sample length	single	Milliseconds
5-8	signal level	single	AMU or dB/Hz
9-12	code phase	single	1/16 th chip
13-16	doppler	single	Hertz @ L1
17-24	time of measurement	double	Seconds

A.9.31 Report Packet 0x5B Satellite Ephemeris Status

This packet is sent in response to command packet 0x3B and when a new ephemeris (based on IODE) is received if enabled with packet 0x8E-A5.

Table A-38 Report Packet 0x5B Data Format

Byte	Item	Type	Units
0	SV PRN number	UINT8	
1-4	time of collection	Single	seconds
5	Health	UINT8	
6	IODE	UINT8	
7-10	toe	Single	seconds
11	fit interval flag	UINT8	
12-15	SV accuracy (URA)	Single	meters

A.9.32 Report Packet 0x5C Satellite Tracking Status

The receiver sends this packet in response to command packet 0x3C.

Table A-39 Report Packet 0x5C Data Format

Byte	Bit	Item	Type	Value	Meaning
0		SV PRN number	UINT8	1-32	PRN
1	0:2	Slot number	bit field	0 0 0 0 0 1 0 1 0 0 1 1 1 0 0 1 0 1	slot 1 slot 2 slot 3 slot 4 slot 5 slot 6
1	3:7	Channel number	bit field	0 0 0 0 0 0 0 1 0 0 1 0 0 0 1 1 0 1 0 0 0 1 0 1 0 1 1 0 0 1 1 1	channel 1 channel 2 channel 3 channel 4 channel 5 channel 6 channel 7 channel 8
2		Acquisition flag	UNIT8	0 1 2	never acquired acquired re-opened search
3		Ephemeris flag	UNIT8	0 >0	Flag not set good ephemeris
4-7		Signal level	Single		AMU or dBc/Hz
8-11		Time of last measurement	Single	secs	GPS time of week
12-15		Elevation angle	Single		Radians
16-19		Azimuth angle	Single		Radians
20		Old measurement flag	UINT8	0 >0	flag not set measurement old
21		Integer msec flag	UINT8	0 1 2 3 4	Don't know msec Known from subframe Verified by bit crossing Verified by good fix Suspect msec error

Table A-39 Report Packet 0x5C Data Format (Continued)

22		Bad data flag	UINT8	0 1 2	Flag not set bad parity bad ephemeris health
23		Data collection flag	UINT8	0 >0	flag not set collection in progress

A.9.33 Report Packet 0x5F-11 EEPROM Segment Status

Report packet 0x5F-11 is sent in response to packet 0x3F-11 and contains the status of all segments in the EEPROM. The Segment Status is bitwise encoded with the status of each segment and is cleared to 0 after it is read. A zero in the bit field indicates that the segment contents are valid. A one in the bit field indicates that the segment contents were corrupt and had to be reverted to their factory default values. Only bits 3-9 are used to generate the minor alarm (bit 10) in packet 0x8F-AC. The Manufacturing and Production parameters (bits 0, 1) do not have factory default values.

Table A-40 Report Packet 0x5F-11 Data Format

Byte	Bit	Item	Type	Value	Meaning
0		Subcode	UINT8	0x11	
1-2	0	Segment Status	UINT16 Bit field		Manufacturing Parameters (0x8F-41)
	1				Production Parameters (0x8F-42)
	2				Not Used (ignore value)
	3				Receiver Configuration
	4				Packet I/O Control
	5				Serial Port Configuration
	6				Timing Outputs
	7				Accurate Position
	8				Self-Survey
	9				Oscillator Disciplining
	10-15			Not Used (ignore value)	

A.9.34 Report Packet 0x6D Satellite Selection List

This packet provides a list of satellites used for position or time-only fixes by the GPS receiver. The packet also provides the PDOP, HDOP, VDOP, and TDOP of that set and provides the current operating mode (full position, automatic 2D/3D, over-determined clock, etc.). This packet has variable length equal to 16+nsvs where “nsvs” is the number of satellites used in the solution. If an SV is rejected for use by the T-RAIM algorithm then the SV PRN value will be negative.

The GPS receiver sends this packet in response to packet 0x24. If enabled with packet 8E-A5, the receiver will send this packet whenever the selection list is updated. The data format is shown below.

Table A-41 Report Packet 0x6D Data Format

Byte	Bit	Item	Type	Value	Meaning
0	0:2	Fix dimension	Bit field	1	OD fix
				3	2D fix
				4	3D fix
	3	Fix mode	Bit field	0	Auto
				1	Manual
	4:7	Number of SVs in fix	Bit field	0-15	Count
1-4		PDOP	Single		PDOP
5-8		HDOP	Single		HDOP
9-12		VDOP	Single		VDOP
13-16		TDOP	Single		TDOP
17 - n		SV PRN	SINT8	+/(-1-32)	PRN

A.9.35 Command Packet 0x70 Filter Configuration

Trimble receivers have a number of filters. Command 0x70 provides control for these filters. It returns Report 0x70. There are three filters associated with 0x70:

- Position-Velocity (PV) Filter
- Static Filter
- Altitude Filter

The Position-Velocity (PV) Filter is the main filter and is used to “soften” the effect of constellation switches on position fixes. The filter has no effect on velocity output (except at slow speeds and a static dynamics code in which case velocity is zeroed) and there is no lag due to vehicle dynamics. There may be a small increase in accuracy however.

A feature of the PV filter is the Static Filter which engages when the receiver is moving very slowly. This feature improves accuracy in the urban environment. The PV filter should be turned off for the following applications:

- Slow-moving environments such as walking or drifting with the current
- When rooftop testing of receivers for moving applications

The altitude filter is a simple averaging filter with a time constant of a few seconds. It should be left on in marine and land applications.

To query for the current settings, use command packet 0x70 with no data bytes. To input new settings, command packet 0x70 is sent with four data bytes as shown below. Also see section A.3 for information on saving the settings to non-volatile memory.

Table A-42 Command Packet 0x70 Data Format

Byte	Item	Type	Value	Meaning
0	PV filter	UINT8	0 1	off on
1	Static filter	UINT8	0 1	off on
2	Altitude filter	UINT8	0 1	on off
3	Reserved	UINT8		

A.9.36 Report Packet 0x70 Filter Configuration

This report is sent as a response to command packet 0x70 when used as either a query or a set. It contains four bytes valued as shown below.

Table A-43 Report Packet 0x70 Data Format

Byte	Item	Type	Value	Meaning
0	PV filter	UINT8	0 1	Off on
1	Static filter	UINT8	0 1	Off on
2	Altitude filter	UINT8	0 1	On off
3	Reserved	UINT8		

A.9.37 Report Packet 0x83 Double Precision XYZ ECEF Position Fix

This packet provides current GPS position fix in XYZ ECEF (Earth-Centered Earth-Fixed) coordinates. If the I/O “position” option is set to “XYZ ECEF” and the I/O double precision option is selected, the receiver sends this packet each time a fix is computed or in response to packet 0x37. The data format is shown below. The time-of-fix is in GPS time or UTC, as selected by the I/O “timing” option. Packet 0x42 provides a single-precision version of this information.

Table A-44 Report Packet 0x83 Data Format

Byte	Item	Type	Units
0-7	X	Double	meters
8-15	Y	Double	meters
16-23	Z	Double	meters
24-31	Clock bias	Double	meters
32-35	Time-of-fix	Single	seconds

A.9.38 Report Packet 0x84 Double Precision LLA Position Fix

This packet provides current GPS position fix in LLA coordinates. If the I/O “position” option is set to “LLA” and the double precision option is selected (see packet 0x35), the receiver sends this packet each time a fix is computed or in response to packet 0x37. The time-of-fix is in GPS time or UTC time as selected by the I/O “timing” option.

Table A-45 Report Packet 0x84 Data Format

Byte	Item	Type	Units
0-7	latitude	Double	radians; + for north, - for south
8-15	longitude	Double	radians; + for east, - for west
16-23	altitude	Double	meters
24-31	clock bias	Double	meters (always relative to GPS)
32-35	time-of-fix	Single	seconds



Caution – When converting from radians to degrees, significant and readily visible errors will be introduced by use of an insufficiently precise approximation for the constant π (π). The value of the constant π as specified in ICD-GPS-200 is 3.1415926535898.

A.9.39 Command Packet 0xBB Request or Set GPS Receiver Configuration

To request the current GPS receiver configuration, packet 0xBB is sent with a single data byte and returns report packet 0xBB in the format shown below. (See Table A-47.)

Table A-46 Command Packet 0xBB Data Format (to request)

Byte	Item	Type	Value	Meaning
0	Subcode	UINT8	0	Request configuration

To set the GPS receiver configuration, send packet 0xBB in the format shown in the table below. The table lists the individual fields within the 0xBB packet. See section A.3 for information on saving the settings to non-volatile memory.

Table A-47 Command and Report Packet 0xBB Data Format

Byte	Item	Type	Value	Meaning	Default
0	Subcode	UINT8	0	Primary receiver configuration data	
1	Receiver Mode	UINT8	0 1 3 4 5 6 7	Automatic (2D/3D) Single satellite (1 SV) Horizontal (2D) Full position (3D) DGPS reference 2D clock hold Over-determined clock	4 (3D)
2	Reserved	UINT8		Value is ignored	
3	Dynamics Code	UINT8	1 2 3 4	Land Sea Air Stationary	Land
4	Reserved	UINT8		Value is ignored	
5-8	Elevation Mask	Single	$0-\pi/2$	Lowest satellite elevation for fixes (radians)	0.175 rad (10 degrees)
9-12	AMU Mask	Single		Minimum signal level for fixes	4
13-16	PDOP Mask	Single		Maximum DOP for fixes	8
17-20	PDOP Switch	Single		Switches 2D/3D mode	6
21	Reserved	UINT8		Value is ignored	
22	Foliage Mode	UINT8	0 1 2	Never Sometimes Always	Sometimes
23-39	Reserved	UINT8		Values are ignored	



Caution – The operation of the ThunderBolt can be affected adversely if incorrect data is entered in the fields associated with packet 0xBB.

A.9.40 Command Packet 0xBC Set or Request Serial Port Configuration

Packet 0xBC is used to set and request the serial port characteristics. To request the settings, packet 0xBC is sent with a single data byte and returns report packet 0xBC.

Table A-48 Command Packet 0xBC Data Format (request)

Byte	Item	Type	Value	Meaning
0	Port Number	UINT8	0 1 FF	Port 1 (standard) Port 2 (not available) Current port (the port you are communicating with)

To set the serial port configuration, send packet 0xBC in the format shown in the table below. The table lists the individual fields within the 0xBC packet. See section A.3 for information on saving the settings to non-volatile memory.

Table A-49 Command and Report Packet 0xBC Field Data Format

Byte	Item	Type	Value	Meaning
0	Port to Change	UINT8	0 1 0xFF	Port 1 (standard) Port 2 (not available) Current port (the port you are communicating with)
1	Input Baud Rate	UINT8	0 1 2 3 4 5 6 7 8 9	None None 300 baud 600 baud 1200 baud 2400 baud 4800 baud 9600 baud 19200 baud 38400 baud
2	Output Baud Rate	UINT8	As above	As above
3	# Data Bits	UINT8	2 3	7 bits 8 bits
4	Parity	UINT8	0 1 2	None Odd Even
5	# Stop Bits	UINT8	0 1	1 bit 2 bits
6	Flow Control	UINT8	0	none
7	Input Protocols	UINT8	0 2	none TSIP
8	Output Protocols	UINT8	0 2	none TSIP
9	Reserved	UINT8	0	

A.10 TSIP Superpackets

Several packets have been added to the core TSIP protocol to provide additional capability for the receivers. In command packets 0x8E and their 0x8F responses, the first data byte is a subcode which indicates the superpacket type. For example, in packet 0x8E-15, 15 is the subcode that indicates the superpacket type. Therefore the ID code for these packets is 2 bytes long followed by the data.

A.10.1 Command Packet 0x8E-41 Request Manufacturing Parameters

This packet is used to request the manufacturing parameters stored in nonvolatile memory. Send this packet with no data bytes (don't forget the subcode) to request packet 0x8F-41.

A.10.2 Command Packet 0x8E-42 Request Production Parameters

This packet is used to request the production parameters stored in nonvolatile memory. Send this packet with no data bytes (don't forget the subcode) to request packet 0x8F-42.

A.10.3 Command Packet 0x8E-45 Revert Segments to Default Settings

This command reverts the specified EEPROM segment (or all segments) to its factory default settings. The ThunderBolt is also reconfigured with the default settings.

Table A-50 Command Packet 0x8E-45 Data Format

Byte	Item	Type	Value	Segment Description
0	Subcode	UINT8	0x45	
1	segment number	UINT8	3 4 5 6 7 8 9 0xFF	Receiver configuration Packet I/O control Serial port configuration Timing output configuration Accurate position Self-survey configuration Disciplining configuration All segments

A.10.4 Command Packet 0x8E-4A Set or Request PPS Characteristics

This packet allows the user to query (by sending the packet with no data bytes) or set the ThunderBolt PPS characteristics. The ThunderBolt responds to a query or set command with packet 0x8F-4A. Negative PPS offset values advance the PPS, and positive values delay the PPS. Therefore, negative PPS offset values are used to compensate for antenna cable delay. It is recommended to leave the bias uncertainty threshold at its factory default value of 300.0 meters.

Table A-51 Command Packet 0x8E-4A Data Format <<segment 6>>

Byte	Item	Type	Value	Meaning
0	Subcode	UINT8	0x4A	
1	PPS output enable	UINT8	0 1	Off On
2	Reserved	UINT8		Value is ignored
3	PPS polarity	UINT8	0 1	Positive (rising edge is on-time) Negative (falling edge is on-time)
4-11	PPS offset or cable delay	Double		Seconds
12-15	Bias uncertainty threshold	Single	300.0	Meters

A.10.5 Command Packet 0x8E-4C Save Segments to EEPROM

This command allows the user to save the parameters of a particular segment (or all segments) to the non-volatile storage chip (EEPROM.)

Table A-52 Command Packet 0x8E-4C Data Format

Byte	Item	Type	Value	Segment Description
0	Subcode	UINT8	0x4C	
1	segment number	UINT8	3 4 5 6 7 8 9 0xFF	Receiver configuration Packet I/O control Serial port configuration Timing output configuration Accurate position Self-survey configuration Disciplining configuration All segments

A.10.6 Command Packet 0x8E-A0 Set DAC Value

Use command packet 0x8E-A0 to set the DAC output voltage or to request the current DAC output voltage plus the parameters describing the DAC. Send this packet with no data to request the DAC voltage. The ThunderBolt responds with packet 0x8F-A0.

Command Packet Data Fields:

Voltage/Value Flag: Use this field to specify that the DAC is to be set either by value or by voltage.

0: Set DAC by voltage

1: Set DAC by value

DAC Voltage/Value: When the Voltage/Value Flag is set to voltage, use this field to specify the voltage as a floating point number. When the Voltage/Value Flag is set to value, use this field to specify the numeric value of the DAC as a 32-bit unsigned number.

Limits:

Voltage: -5.0V to +5.0V

Value: 0x00000 to 0xFFFFF (20-bits)

To set the DAC voltage send packet 0x8E-A0 in the format shown below.



Note – Oscillator disciplining must be disabled (see packet 0x8E-A3) to use this command to set the DAC voltage.

Table A-53 Command Packet 0x8E-A0 Data Format

Byte	Item	Type	Value	Description
0	Subcode	UINT8	0xA0	
1	Voltage/Value Flag	UINT8	0 1	set DAC Voltage set DAC Value
2-5	DAC Voltage/Value	SINGLE/ UINT32		DAC Voltage/Value

A.10.7 Command Packet 0x8E-A1 10 MHz Output Sense

The 10 MHz output is synchronized with the timing edge of the 1PPS. This point will occur at a zero crossing of the 10 MHz output (see chapter 5.) At this zero crossing the 10 MHz output may be rising or falling. Use command packet 0x8E-A1 to set the 10 MHz output parameters or to request (with no data bytes) the current settings.

Command Packet Data Fields:

10 MHz Sense: Use this field to select which zero-volt crossing of the 10 MHz output to align with the on-time edge of the 1 PPS output.

- 0: Align the zero-volt crossing of the positive going (rising) slope to the 1 PPS.
- 1: Align the zero-volt crossing of the negative going (falling) slope to the 1 PPS.

Table A-54 Command Packet 0x8E-A1 Data Format <<segment 6>>

Byte	Item	Type	Value	Description
0	Subcode	UINT8	0xA1	
1	10 MHz Sense	UINT8	0 1	Rising (default) Falling



Note – This command does not work on early versions (manufactured before March 1998) of the ThunderBolt.

A.10.8 Command Packet 0x8E-A2 UTC/GPS Timing

Command packet 0x8E-A2 sets the UTC/GPS timing mode (time and date fields) in packet 0x8F-AB, and the temporal location of the ThunderBolt output PPS. Send packet 0x8E-A2 with no data to request the current settings. The ThunderBolt replies with response packet 0x8F-A2.

Table A-55 Command Packet 0x8E-A2 Data Format <<segment 6>>

Byte	Bit	Item	Type	Value	Meaning
0		Subcode	UINT8	0xA2	
1	0	UTC/GPS time	bit field	0	GPS time/date in packet 0x8F-AB
	1			UTC time/date in packet 0x8F-AB	
	1		bit field	0	PPS referenced to GPS time
				1	PPS referenced to UTC time

A.10.9 Command Packet 0x8E-A3 Issue Disciplining Command

Use command packet 0x8E-A3 to issue an oscillator disciplining command. ThunderBolt responds with packet 0x8F-A3 in the same format as packet 0x8E-A3.

Table A-56 Command Packet 0x8E-A3 Data Format

Byte	Item	Type	Value	Meaning
0	Subcode	UINT8	0xA3	
1	Disciplining Command	UINT8	0	Place PPS on time (jam sync)
			1	Transition to Recovery state.
			2	Transition to Manual Holdover.
			3	Transition from Manual Holdover.
			4	Disable oscillator disciplining.
			5	Enable oscillator disciplining.

A.10.10 Command Packet 0x8E-A4 Test Modes

The ThunderBolt provides a test mode of operation that allows the user to set the time and UTC parameters. Packet 0x8F-AC provides a status bit (minor alarm bit 8) to warn the user that the ThunderBolt is operating in a test mode.

Note that test mode 3 does not actually cause the ThunderBolt to enter a test mode, but instead provides a means for the user to send UTC parameters to the ThunderBolt that will be used in test mode 1.

Test Mode 0 Data Fields:

Test Mode: Set this field to 0 to exit test mode and return the ThunderBolt to normal operations. A reset or power cycle will also cause the ThunderBolt to exit test mode.

Test Mode 1 Data Fields:

Test Mode: Setting this field to 1 tells the ThunderBolt to enter the user time test mode. The ThunderBolt will set the time to the week number and TOW sent with this packet. The ThunderBolt will then increment this time once per second. The time in packets 0x8F-AB and 0x8F-A7 will show the user test time, but all other packets that have time fields will be unaffected.

Week Number: This field contains the week number for the user time test mode.

Time-of-Week: This field contains the TOW for the user time test mode.

Test Mode 3 Data Fields:

Note – For a more detailed description of UTC parameters see the GPS SPS Signal Specification

Test Mode: Setting this field to 3 tells the ThunderBolt that the following fields contain the user UTC parameters that are to be used while in test mode 1.

A_0: This field is the fractional second offset of GPS from UTC at the reference time in seconds.

A_1: This field is the rate of change of fractional second offset of GPS from UTC in seconds/second.

delta_t_LS: Current integer leap seconds

t_ot: This field is the reference time-of-week for the A_0/A_1 parameters.

WN_t: This field is the reference week number for the A_0/A_1 parameters.

WN_LSF: This field is the week number of a future leap second event

DN: This field is the day number of a future leap second event.

delta_t_LSF: This field is the integer number of future leap seconds.

Table A-57 0x8E-A4 Test Mode 0 Data Format

Byte	Item	Type	Description
0	Subcode	UINT8	0xA4
1	Test Mode	UINT8	0 = Exit test mode

Table A-58 0x8E-A4 Test 1 Mode 1 Data Format

Byte	Item	Type	Description
0	Subcode	UINT8	0xA4
1	Test Mode	UINT8	1 = Set absolute time, ignore GPS time
2-3	Week Number	UINT16	Week number (0-1023)
4-7	Time of Week	UINT32	Seconds (0-604799)

Table A-59 0x8E-A4 Test Mode 3 Data Format

Byte	Item	Type	Description
0	Subcode	UINT8	0xA4
1	Test Mode	UINT8	3 = Send user UTC parameter
2-5	A_0	Single	Seconds
6-9	A_1	Single	Seconds/second
10-11	delta_t_LS	SINT16	Seconds
12-15	t_ot	UINT32	Seconds
16-17	WN_t	UINT16	Week number (0-1023)
18-19	WN_LSF	UINT16	Week number (0-1023)
20-21	DN	UINT16	Day number (1-7)
22-23	delta_t_LSF	SINT16	Seconds

A.10.11 Command Packet 0x8E-A5 Set or Request Packet Broadcast Mask

Use command packet 0x8E-A5 to set the packet broadcast masks or to request the current mask settings. The ThunderBolt replies to requests with response packet 0x8F-A5. The broadcast mask is bitwise encoded to allow the user to turn on and off the automatic output (broadcast) of certain packets. For those broadcast packets that have multiple formats, the ThunderBolt will broadcast only one of the formats. If more than one of the formats is masked on for broadcast, then the format with the greatest precision of content masked on will be sent and the rest will not. For each bit in the mask that is used, the coding is as follows:

- 0: Turn off automatic output (broadcast) of this packet
- 1: Turn on automatic output (broadcast) of this packet

Table A-60 Command Packet 0x8E-A5 Data Format <<segment 4>>

Byte	Bit	Item	Type	Description
0		Subcode	UINT8	0xA5
1-2	0 1 2 3 4 5 6	Mask 0	bit field	0x8F-AB, Primary Timing Information Reserved 0x8F-AC, Supplemental Timing Information Reserved 0x8F-A7, Individual Satellite Solutions (Format 0) 0x8F-A7, Individual Satellite Solutions (Format 1) 0x58 GPS System Data, 0x5B Ephemeris Status, 0x6D Selection List
3-4		Mask 2	bit field	Reserved

A.10.12 Command Packet 0x8E-A6 Issue Self-Survey Command

Use command packet 0x8E-A6 to issue a self-survey command. The ThunderBolt responds with packet 0x8F-A6 in the same format as packet 0x8E-A6.

Table A-61 Command Packet 0x8E-A6 Data Format

Byte	Item	Type	Value	Meaning
0	Subcode	UINT8	0xA6	
1	self-survey command	UINT8	0	Restart self-survey

A.10.13 Command Packet 0x8E-A8 Set or Request Disciplining Parameters

This packet allows the user to change key disciplining parameters in the ThunderBolt. This packet is usually intended to be used only when instructed by the factory. Incorrect use of this packet will most likely cause the ThunderBolt timing outputs to be degraded severely. However, the “Type 2” (Recovery Mode) parameters are intended to be set by the user to suit the application. Send this packet with the type field only to request the current settings. The ThunderBolt replies to sets and requests with packet 0x8F-A8.

Type 0 Data Fields:

Type: A zero in this field indicates that the packet contains loop dynamics information.

Time Constant: This field carries the time constant of the disciplining control loop.

Damping Factor: This field carries the damping of the disciplining control loop.

Type 1 Data Fields:

Type: A one in this field indicates that the packet contains 10MHz oscillator parameters.

OCXO Constant: This field carries the OCXO constant in Hz/Volt.

OCXO Minimum Control Voltage: This field carries the minimum (most negative) control voltage that can be applied to the 10MHz oscillator's control voltage input.

OCXO Maximum Control Voltage: This field carries the maximum (most positive) control voltage that can be applied to the 10MHz oscillator's control voltage input.

Type 2 Data Fields:

Type: A two in this field indicates that the packet contains Recovery Mode parameters. These parameters allow the user to control the Recovery process. During Recovery, the ThunderBolt will remove any PPS offset accumulated during periods of Holdover by either shifting the PPS into alignment or by shifting the frequency of the 10MHz oscillator by a specified amount until the PPS has slewed back into alignment or by using both methods. The following two parameters control these recovery methods. If a fast recovery is desired, then allow jam syncs to be used. If it is important to maintain 10 million clock cycles per PPS pulse then disable jam syncs and set the maximum frequency offset to a tolerable value.

Jam Sync Threshold: This field carries the jam sync threshold in nanoseconds used during Recovery Mode. While in Recovery Mode, if the PPS offset is above this threshold the ThunderBolt will automatically perform a jam sync to shift the PPS into alignment with GPS. The minimum allowed value is 50ns. Setting a value less than or equal to 0ns will disable automatic jam syncs during Recovery (though the user can still issue a jam sync command with packet 0x8E-A3.)

Maximum Frequency Offset: This field carries the maximum allowable frequency offset in ppb (parts per billion or $1e-9$) of the 10MHz oscillator during Recovery Mode. While in Recovery Mode, the ThunderBolt will remove any PPS offset accumulated during periods of Holdover by shifting the frequency of the oscillator by an amount up to the value specified. The minimum allowed value is 5ppb.

Type 3 Data Fields:

Type: A three in this field indicates that the packet contains the initial DAC voltage parameter.

Initial DAC Voltage: At reset, the oscillator's frequency control voltage is set to this value.

Table A-62 Command Packet 0x8E-A8 Type 0 Data Format <<segment 9>>

Byte	Item	Type	Description
0	Subcode	UINT8	0xA8
1	Type	UINT8	0 = loop dynamics
2-5	Time constant	Single	Seconds
6-9	Damping factor	Single	Dimensionless

Table A-63 Command Packet 0x8E-A8 Type 1 Date Format <<segment 9>>

Byte	Item	Type	Description
0	Subcode	UINT8	0xA8
1	Type	UINT8	1 = oscillator parameters
2-5	oscillator gain constant	Single	Hz/volt
6-9	minimum control voltage	Single	volts
10-13	maximum control voltage	Single	volts

Table A-64 Command Packet 0x8E-A8 Type 2 Date Format <<segment 9>>

Byte	Item	Type	Description
0	Subcode	UINT8	0xA8
1	Type	UINT8	2 = recovery mode parameters
2-5	Jam sync threshold	Single	ns
6-9	Maximum frequency offset	Single	ppb (parts per billion or 1e-9)

Table A-65 Command Packet 0x8E-A8 Type 3 Date Format <<segment 9>>

Byte	Item	Type	Description
0	Subcode	UINT8	0xA8
1	Type	UINT8	3 = initial DAC voltage
2-5	Initial DAC Voltage	Single	Volts

A.10.14 Command Packet 0x8E-A9 Set or Request Self-Survey Parameters

Use command packet 8E-A9 to set the self-survey parameters or to request the current settings. The ThunderBolt replies with response packet 8F-A9.

Data Fields:

Self-Survey Enable: Use this field to enable or disable the self-survey mechanism.

0: Disable the self-survey mechanism

1: Enable the self-survey mechanism

Position Save Flag: Use this field to tell the self-survey mechanism to automatically save (or to not save) the self-surveyed position at the end of the self-survey procedure.

0: Don't automatically save the surveyed position when the self-survey is complete

1: Automatically save the surveyed position when the self-survey is complete.

Self-Survey Length: Use this field to specify the number of position fixes that are to be averaged together to form the self-surveyed position used for clock-only fixes.

Limits: 1 to $(2^{32} - 1)$ fixes.

Table A-66 Command Packet 8E-A9 Data Format <<segment 8>>

Byte	Item	Type	Value	Description
0	Subcode	UINT8	0xA9	
1	Self-Survey Enable	UINT8	0 1	disabled enabled (factory default)
2	Position Save Flag	UINT8	0 1	don't save position (factory default) save self-surveyed position
3-6	Self-Survey Length	UINT32	see above	Number of fixes (factory default = 2000)
7-10	Reserved	UINT32	0	0

A.10.15 Command Packet 0x8E-AB Request Primary Timing Packet

Use command packet 0x8E-AB to request the primary timing packet 0x8F-AB. By default, the ThunderBolt automatically sends packet 0x8F-AB once per second so it is not necessary to request it. To receive 0x8F-AB information by request only use packet 0x8E-A5 to disable the automatic output.

The Request Type item determines how the ThunderBolt will reply to this command.

Request Type 0: The most current primary timing values will be sent in packet 0x8F-AB immediately.

Request Type 1: The response is not sent immediately. Instead packet 0x8F-AB is sent within 20ms after the next PPS output. This is the same time that the packet would be automatically sent if enabled.

Request Type 2: Same as type 1 except that both 0x8F-AB and 0x8F-AC are sent after the next PPS output.

Table A-67 Command Packet 0x8E-AB Data Format

Byte	Item	Type	Value	Meaning
0	Subcode	UINT8	0xAB	
1	Request Type	UINT8	0 1 2	Send 0x8F-AB immediately Send 0x8F-AB on-time next second Send 0x8F-AB and 0x8F-AC on-time next second

A.10.16 Command Packet 0x8E-AC Request Supplemental Timing Packet

Use command packet 0x8E-AC to request the supplemental timing packet 0x8F-AC. By default, the ThunderBolt automatically sends packet 0x8F-AC once per second so it is not necessary to request it. To receive 0x8F-AC information by request only use packet 0x8E-A5 to disable the automatic output.

The Request Type item determines how the ThunderBolt will reply to this command.

Request Type 0: The most current supplemental timing values will be sent in packet 0x8F-AC immediately.

Request Type 1: The response is not sent immediately. Instead packet 0x8F-AC is sent within 300ms after the next PPS output. This is the same time that the packet would be automatically sent if enabled.

Request Type 2: Same as type 1 except that both 0x8F-AB and 0x8F-AC are sent after the next PPS output.

Table A-68 Command Packet 0x8E-AC Data Format

Byte	Item	Type	Value	Meaning
0	Subcode	UINT8	0xAC	
1	Request Type	UINT8	0 1 2	Send 0x8F-AC immediately Send 0x8F-AC on-time next second Send 0x8F-AB and 0x8F-AC on-time next second

A.10.17 Report Packet 0x8F-41 Stored Manufacturing Operating Parameters

This packet is sent in response to a command 0x8E-41.

Table A-69 Stored Manufacturing Operating Parameters

Byte	Item	Type	Value
0	Subcode	UINT8	0x41
1-2	Board serial number prefix	SINT16	
3-6	Board serial number	UINT32	
7	Year of build	UINT8	
8	Month of build	UINT8	
9	Day of build	UINT8	
10	Hour of build	UINT8	
11-14	Oscillator offset	Single	
15-16	Test code identification number	UINT16	

A.10.18 Report Packet 0x8F-42 Stored Production Parameters

This packet is sent in response to 0x8E-42.

Table A-70 Stored Production Parameter

Byte	Item	Type	Value
0	Subcode	UINT8	0x42
1	Production options prefix	UINT8	
2	Production number extension	UINT8	
3-4	Case serial number prefix	UINT16	
5-8	Case serial number	UINT32	
9-12	Production number	UINT32	
13-14	Reserved	UINT16	
15-16	Machine identification number	UINT16	
17-18	Reserved	UINT16	

A.10.19 Report Packet 0x8F-4A PPS Characteristics

This is sent in response to packet 0x8E-4A. See Table A-6 for factory default settings.

Table A-71 Set PPS Characteristics

Byte	Item	Type	Value	Meanings
0	subcode	UINT8	0x4A	
1	PPS output enable	UINT8	0 1	off on
2	Reserved	UINT8		Reserved
3	PPS polarity	UINT8	0 1	Positive (rising edge is on-time) Negative (falling edge is on-time)
4-11	PPS offset or cable delay	DOUBLE		Seconds
12-15	bias uncertainty threshold	SINGLE	300.0	Meters

A.10.20 Report Packet 0x8F-45 Revert Segments to Factory Defaults

This packet is sent in response to packet 0x8E-45.

Table A-72 Save Segments to EEPROM

Byte	Item	Type	Value	Meaning
0	Subcode	UINT8	0x45	
1	segment number	UINT8	3 4 5 6 7 8 9 0xFF	Receiver configuration Packet I/O control Serial port configuration Timing output configuration Accurate position Self-survey configuration Disciplining configuration All segments

A.10.21 Report Packet 0x8F-4C Save Segments to EEPROM

This packet is sent in response to packet 0x8E-4C.

Table A-73 Save Segments to EEPROM

Byte	Item	Type	Value	Meaning
0	Subcode	UINT8	0x4C	
1	segment number	UINT8	3 4 5 6 7 8 9 0xFF	Receiver configuration Packet I/O control Serial port configuration Timing output configuration Accurate position Self-survey configuration Disciplining configuration All segments

A.10.22 Report Packet 0x8F-A0 DAC Value

This packet is sent in response to packet 0x8E-A0.

Response Packet Data Fields:

DAC Value: The current numeric value of the DAC

DAC Voltage: The current output voltage of the DAC in Volts.

DAC Resolutions: The number of bits used in the DAC

DAC Data Format: The format of the DAC value

0: Offset binary

1: Two's complement

Minimum DAC Voltage: The minimum (most negative) voltage that the DAC can produce.

Maximum DAC Voltage: The maximum (most positive) voltage that the DAC can produce.

Table A-74 Report Packet 0x8F-A0 Data Format

Byte	Item	Type	Value	Description
0	Subcode	UINT8	0xA0	
1-4	DAC Value	UINT32		DAC value
5-8	DAC Voltage	single		Volts
9	DAC resolution	UINT8		number of bits
10	DAC data format	UINT8	0 1	offset binary 2's complement
11-14	Min DAC voltage	single		Volts
15-18	Max DAC voltage	single		Volts

A.10.23 Report Packet 0x8F-A1 10 MHz Sense

The 10 MHz is synchronized with the timing edge of the 1PPS. This point will occur at a zero crossing of the 10 MHz (see chapter 5). At this zero crossing the 10 MHz may be rising or falling. This packet is sent in response to packet 0x8E-A1.

Table A-75 Report Packet 0x8F-A1 Description <<segment 6>>

Byte	Item	Type	Value	Description
0	Subcode	UINT8	0xA1	0xA1
1	10 MHz Sense	UINT8	0 1	Rising (default) falling



Note – This command does not work on early versions (manufactured before March 1998) of the ThunderBolt. Earlier versions will not respond to the command to change sense to falling.

A.10.24 Report Packet 0x8F-A2 UTC/GPS Timing Mode

This packet is sent in response to command packet 0x8E-A2.

Table A-76 Report Packet 0x8F-A2 Data Format <<segment 6>>

Byte	Bit	Item	Type	Value	Meaning
0		Subcode	UINT8	0xA2	
1	0	UTC/GPS time	bit field	0	GPS time/date in packet 0x8F-AB
	1		bit field	1	UTC time/date in packet 0x8F-AB
				0	PPS referenced to GPS time
				1	PPS referenced to UTC time

A.10.25 Report Packet 0x8F-A4 Test Modes

This packet is sent in response to 0x8E-A4. The data fields are as follows:

Table A-77 0x8F-A4 Exit Test Mode 0 Data Format

Byte	Item	Type	Description
0	Subcode	UINT8	0xA4
1	Test Mode	UINT8	0 = Exit test mode

Table A-78 0x8F-A4 Test 1 Mode 1 Data Format

Byte	Item	Type	Description
0	Subcode	UINT8	0xA4
1	Test Mode	UINT8	1 = Set absolute time, ignore GPS time
2-3	Week Number	UINT16	Week number (0-1023)
4-7	Time of Week	UINT32	Seconds (0-604799)

Table A-79 0x8F-A4 Test Mode 3 Data Format

Byte	Item	Type	Description
0	Subcode	UINT8	0xA4
1	Test Mode	UINT8	3 = Send user UTC parameter
2-5	A_0	Single	Seconds
6-9	A-1	Single	Seconds/second
10-11	delta_t_LS	SINT16	Seconds
12-15	t_ot	UINT32	Seconds
16-17	WN_t	UINT16	Week number (0-1023)
18-19	WN_LSF	UINT16	Week number (0-1023)
20-21	DN	UINT16	Day number (1-7)
22-23	delta_t_LSF	SINT16	Seconds

A.10.26 Report Packet 0x8F-A5 Packet Broadcast Mask

This packet is sent in response to packet 0x8E-A5 command and describes which packets are currently automatically broadcast. A '0' in a bit indicates that the packet is not sent automatically, and a '1' in a bit field indicates that the packet is enabled for automatic output.

Table A-80 Report Packet 0x8F-A5 Data Format <<segment 4>>

Byte	Bit	Item	Type	Description
0		Subcode	UINT8	0xA5
1-2	0 1 2 3 4 5 6	Mask 0	bit field	0x8F-AB, Primary Timing Information (default on) Reserved 0x8F-AC, Supplemental Timing Information (default on) Reserved 0x8F-A7, Individual Satellite Solutions (Format 0) 0x8F-A7, Individual Satellite Solutions (Format 1) 0x58 GPS System Data, 0x5B Ephemeris Status, 0x6D Selection List
3-4		Mask 2	bit field	reserved

A.10.27 Report Packet 0x8F-A7 Individual Satellite Solutions

This broadcast packet provides individual satellite solutions as well as the combined timing solutions. Two formats of this packet are supported: a floating-point form and an integer form. This packet is broadcast once per second if enabled with the 0x8E-A5 packet mask command. Packet 0x8E-A5 allows the user to select which format will be broadcast. If both formats are selected the ThunderBolt will send format 0 (floating point) only.

For clock bias numbers, a positive sign indicates that the ThunderBolt PPS occurs after the GPS PPS. For clock bias rate numbers, a positive sign indicates that the ThunderBolt 10MHz frequency output is running slow relative to GPS.

Data Fields:

Format: This field defines the format of the data that follows. When set to 0, the floating point formatted data follows. When set to 1, the integer formatted data follows.

Time-of-Fix: This field is the time of the fix.

Clock Bias (combined): This field is the combined clock bias solution.

Clock Bias Rate (combined): This field is the combined clock bias rate solution.

Satellite ID: This field is the PRN number of the individual satellite.

Clock Bias (by satellite): This field is the clock bias as determined by the individual satellite.

Table A-81 Report Packet 0x8F-A7 Format 0 Data Format

Byte	Item	Type	Value	Description
0	Subcode	UINT8	0xA7	
1	Format	UINT8	0	Reporting floating point numbers
2-5	Time-of-fix	UINT32		Time-of-week (seconds)
6-9	Clock bias (combined)	Single		Seconds
10-13	Clock bias rate (combined)	Single		Seconds/second
5n+9	Satellite ID	UINT8	0 1-32	channel not used in solution satellite PRN
5n+10- 5n+13	Clock bias by satellite	Single		Seconds

Table A-82 Report Packet 0x8F-A7 Format 1 Data Format

Byte	Item	Type	Value	Description
0	Subcode	UINT8	0xA7	
1	Format	UINT8	1	Reporting integer numbers
2-5	Time-of-fix	UINT32		Time-of-week (seconds)
6-7	Clock bias (combined)	SINT16		100 ps units
8-9	Clock bias rate (combined)	SINT16		Fractional frequency offset (x 1e-12)
3n+7	Satellite ID	UINT8	0 1-32	channel not used in solution satellite PRN
3n+8 3n-9	Clock bias by satellite	SINT16		100 ps units



Note – 8 sets of satellite ID and data are sent with n=1, 2, . . . 8

A.10.28 Report Packet 0x8F-A8 Disciplining Parameters

This packet is sent in response to 0x8E-A8. The format is shown below.

Table A-83 Report Packet 0x8F-A8 Type 0 Data Format

Byte	Item	Type	Description
0	Subcode	UINT8	0xA8
1	Type	UINT8	0 = Loop dynamics
2-5	Time constant	Single	seconds
6-9	Damping factor	Single	Dimensionless

Table A-84 Report Packet 0x8F-A8 Type 1 Data Format

Byte	Item	Type	Description
0	Subcode	UINT8	0xA8
1	Type	UINT8	1 = Oscillator parameters
2-5	Oscillator constant	Single	Hz/volt
6-9	Minimum control voltage	Single	Volts
10-13	Maximum control voltage	Single	Volts

Table A-85 Report Packet 0x8F-A8 Type 2 Data Format

Byte	Item	Type	Description
0	Subcode	UINT8	0xA8
1	Type	UINT8	2 = recovery mode parameters
2-5	Jam sync threshold	Single	ns
6-9	Maximum frequency offset	Single	ppb (parts per billion or 1e-9)

Table A-86 Report Packet 0x8F-A8 Type 3 Data Format

Byte	Item	Type	Description
0	Subcode	UINT8	0xA8
1	Type	UINT8	3 = initial DAC voltage
2-5	Initial DAC Voltage	Single	Volts

A.10.29 Report Packet 0x8F-A9 Self-Survey Parameters

Packet 0x8F-A9 is sent in response to command packet 0x8E-A9 and describes the current self-survey parameters.

Table A-87 Report Packet 0x8F-A9 Data Format

Byte	Item	Type	Value	Description
0	Subcode	UINT8	0xA9	0xA9
1	Self-Survey Enable	UINT8	0 1	Disabled Enabled (factory default)
2	Position Save Flag	UINT8	0 1	Don't save position (factory default) Save self-surveyed position
3-7	Self-Survey Length	UINT32		Number of fixes (factory default = 2000)
8-11	Reserved	UINT32	0	

A.10.30 Report Packet 0x8F-AB Primary Timing Packet

This automatic output packet provides time information once per second if enabled with packet 0x8E-A5. GPS week number, GPS time-of-week (TOW), UTC integer offset, time flags, date and time-of-day (TOD) information is provided. This packet can be requested with packet 0x8E-AB. This packet will begin transmission within 20 ms after the PPS pulse to which it refers.

Data Fields:

Time of Week: This field represents the number of seconds since Sunday at 00:00:00 GPS time for the current GPS week. Time of week is often abbreviated as TOW.

Week Number: This field represents the current GPS week number. GPS week number 0 started on January 6, 1980. Unfortunately, the GPS system has allotted only 10-bits of information to carry the GPS week number and therefore it rolls-over to 0 in just 1024 weeks (19.6 years,) and there is no mechanism built into GPS to tell the user to which 1024 week epoch the week number refers. The first week number roll-over will occur as August 21, 1999 (GPS) transitions to August 22, 1999 (GPS). The ThunderBolt adjusts for this week rollover by adding 1024 to any week number reported by GPS which is less than week number 936 which began on December 14, 1997. With this technique, the ThunderBolt will provide an accurate translation of GPS week number and TOW to time and date until July 30, 2017.

UTC Offset: This field represents the current integer leap second offset between GPS and UTC according to the relationship: Time (UTC) = Time (GPS) - UTC Offset. The UTC offset information is reported to ThunderBolt by the GPS system and can take up to 12.5 minutes to obtain. Before the ThunderBolt has received UTC information from the GPS system, it is only capable of representing time in the GPS time scale, and the UTC offset will be shown as 0.

Timing Flags: This field is bitwise encoded to provide information about the timing outputs. Unused bits should be ignored.

Bit 0: When 0, the date and time fields broadcast in packet 0x8F-AB are in the GPS time scale. When 1, these fields are in the UTC time scale and are adjusted for leap seconds. Use command packet 0x8E-A2 to select either GPS or UTC time scales.

Bit 1: When 0, the PPS output is aligned to GPS. When 1, the PPS output is aligned to UTC. Use command packet 0x8E-A2 to select either GPS or UTC PPS alignment.

Bit 2: When 0, time has been set from GPS. When 1, time has not yet been set from GPS.

Bit 3: When 0, UTC offset information has been received. When 1, UTC offset information is not yet known.

Bit 4: When 0, time is coming from GPS. When 1, the ThunderBolt is in a test mode and time is being generated by the test mode selected by the user. See packet 0x8E-A4, Test Modes.

Time of Day: The time of day is sent in hours-minutes-seconds format and varies from 00:00:00 to 23:59:59, except when time is in UTC and a leap second insertion occurs. In this case the time will transition from 23:59:59 to 23:59:60 to 00:00:00. Use command packet 0x8E-A2 to select either the GPS or UTC time scale.

Date: The date is sent in day-month-year format. Use command packet 0x8E-A2 to select either the GPS or UTC time scale.

Table A-88 Report Packet 0x8F-AB Data Format

Byte	Bit	Item	Type	Value	Description
0		Subcode	UINT8		0xAB
1-4		Time of Week	UINT32		GPS seconds of week
5-6		Week Number	UINT16		GPS Week Number (see above)
7-8		UTC Offset	SINT16		UTC Offset (seconds)
9	0	Timing Flag	Bit field	0	GPS time
	1			1	UTC time
	2			0	GPS PPS
	3			1	UTC PPS
	4			0	time is set
				1	time is not set
				0	have UTC info
				1	no UTC info
				0	time from GPS
				1	time from user
10		Seconds	UINT8	0-59	(60 for UTC leap second event)
11		Minutes	UINT8	0-59	Minutes of Hour
12		Hours	UINT8	0-23	Hour of Day
13		Day of Month	UINT8	1-31	Day of Month
14		Month	UINT8	1-12	Month of Year
15-16		Year	UINT16		Four digits of Year (e.g. 1998)

A.10.31 Report Packet 0x8F-AC Supplemental Timing Packet

This broadcast packet provides supplemental timing information once per second if enabled with packet 0x8E-A5. Information regarding position, unit status and health, and the operational state of the unit is provided. This packet can be requested with packet 0x8E-AC. When enabled, this packet is transmitted once per second shortly after packet 0x8F-AB.

The position sent in packet 0x8F-AC depends on the Receiver Operating Mode and on self-survey activity. When a self-survey is in progress, the position sent is the running average of all of the position fixes collected so far. When the self-survey ends or whenever the receiver is using a time-only operating mode, then the position sent is the position the receiver is using to perform time-only fixes. When the self-survey is disabled or otherwise inactive and the receiver is using a position fix operating mode, then the position sent is the position fix computed on the last second.

Data Fields:

Receiver Mode: This field shows the fix mode that the GPS receiver is currently configured for. The ThunderBolt spends most of its time in the Overdetermined Clock mode where it uses all available satellites to perform the best time-only fix possible. See packet BB for a description of all available receiver modes.

Disciplining State: This field shows the current disciplining state. See Chapter 5 for further explanation of disciplining state.

Self-Survey Progress: When a self-survey procedure is in progress, this field shows the progress of the survey as a percentage of fixes collected so far. The self-survey will be complete when the self-survey progress reaches 100 percent.

Holdover Duration: When in the Manual or Auto Holdover state, this field shows the amount of time spent in holdover in seconds. When the unit is not in a holdover state, this field shows the amount of time the ThunderBolt spent the last time it was in a holdover state.

Critical Alarms: This field is bitwise encoded with several critical alarm indicators. A critical alarm indicates a condition that would tend to severely impair the function of the ThunderBolt. For each bit, a value of 0 means that the condition is not indicated. Bits not described below should be ignored.

Bit 0: When 1, indicates that a ROM checksum error was detected at reset.

Bit 1: When 1, indicates that the RAM check failed at reset.

Bit 2: When 1, indicates that one or more power supply voltages has failed.

Bit 3: When 1, indicates that the FPGA check has failed at reset or during operation.

Bit 4: When 1, indicates that the oscillator control voltage is at a rail. If this condition persists then the ThunderBolt can no longer bring the frequency of the oscillator into alignment with GPS and is most likely in need of a new oscillator. This condition should not occur within 12 years of operation.

Minor Alarms: This field is bitwise encoded with several minor alarm indicators. A minor alarm indicates a condition that the user should be alerted to, but does not indicate an immediate (or necessarily any) impairment of functionality. For each bit, a value of 0 means that the condition is not indicated. Bits not described below should be ignored.

Bit 0: When 1, indicates that the oscillator control voltage is near a rail. If this condition persists, then the oscillator is within 2 years of becoming untunable, at which point the unit will need a new oscillator. This condition should not occur for at least 10 years of use and is a result of oscillator crystal aging.

Bit 1: When 1, indicates that the antenna input connection is open. More precisely, this bit indicates that the antenna input is not drawing sufficient current. Normally, the ThunderBolt provides power to the antenna's LNA (Low Noise Amplifier) through the center conductor of the antenna cable. On-board circuitry senses this current draw, and if low, this condition will be indicated. However, when the antenna is powered elsewhere (e.g. when using a splitter) then an antenna open condition is expected and does not imply a fault nor does it impair the operation of the ThunderBolt.

Bit 2: When 1, indicates that the antenna input is shorted. More precisely, this bit indicates that the antenna input is drawing too much current. On-board protection circuitry prevents any damage to the ThunderBolt when its antenna input is shorted to any voltage ranging from ground to over +12VDC. This condition tends to indicate a fault in either the antenna cable or the antenna itself.

Bit 3: When 1, indicates that no satellites are yet usable. In order for a satellite to be usable, it must be tracked long enough to obtain ephemeris and health data.

Bit 4: When 1, indicates that the oscillator is not being disciplined to GPS. Before the ThunderBolt can begin disciplining the oscillator, it must begin receiving information from the GPS receiver. This occurs anytime the receiver is performing fixes.

Bit 5: When 1, indicates that a self-survey procedure is in progress.

Bit 6: When 1, indicates that there is no accurate position stored in EEPROM.

Bit 7: When 1, indicates that the GPS system has alerted the ThunderBolt that a leap second transition is pending.

Bit 8: When 1, indicates that the ThunderBolt is operating in one of its test modes.

Bit 9: When 1, indicates that the accuracy of the position being used for a time-only fix is questionable. While operating in the over-determined clock mode (which is most of the time) and there are at least 2 satellites available, the ThunderBolt can detect position inaccuracies as small as ½ to 1 mile. If this bit is ever set, it is likely that the ThunderBolt is using a stored position but has been moved to a new site. The stored position should be cleared (packet 0x8E-45) and a new position should be established either by user input (packet 0x31 or 0x32) or by self-survey (packet 0x8E-A6.)

Bit 10: When 1, indicates that one or more EEPROM segments were found to be corrupt at reset and had to be set to their factory default settings. Use packet 0x3F-11 to retrieve details about which segments were corrupt and to clear this bit. The ThunderBolt will send packet 0x5F-11 with the segment status. Only bits 3-9 of the segment status are used to set this alarm bit.

Bit 11: When 1, indicates that the almanac is not current or complete.

GPS Decoding Status: This field indicates the decoding status of the GPS receiver.

Disciplining Activity: This field indicates the current activity of the disciplining mechanism.

PPS Offset: This field carries the offset of the PPS output relative to UTC or GPS as reported by the GPS receiver in nanoseconds. Positive values indicate that the ThunderBolt's PPS is coming out late relative to GPS or UTC.

10 MHz Offset: This field carries the frequency offset of the 10 MHz output relative to UTC or GPS as reported by the GPS receiver in ppb (parts-per-billion.) Positive values indicate that the ThunderBolt's 10MHz clock is running slow relative to GPS or UTC.

DAC Value: This field shows the numeric value of the Digital-to-Analog Converter (DAC) used to produce a voltage that controls the frequency of the 10 MHz oscillator. This value will vary from 0 (minimum voltage) to 0xFFFFF (maximum voltage.)

DAC Voltage: This field show the voltage output of the DAC. This value will vary from -5V to +5V on a standard ThunderBolt.

Temperature: This field shows the temperature (in Celsius) as reported by ThunderBolt's on-board temperature sensor.

Latitude: This field carries the latitude of the position being shown. The units are in radians and vary from $-\pi/2$ to $+\pi/2$. Negative values represent southern latitudes. Positive values represent northern latitudes.

Longitude: This field carries the longitude of the position being shown. The units are in radians and vary from $-\pi$ to $+\pi$. Negative values represent western longitudes. Positive values represent eastern longitudes.

Altitude: This field carries the altitude of the position being shown. The units are in meters (WGS-84.)

Table A-89 Report Packet 0x8F-AC Data Format

Byte	Item	Type	Value	Description
0	Subcode	UINT8	0xAC	
1	Receiver Mode	UINT8	0 1 3 4 5 6 7	Automatic (2D/3D) Single Satellite (Time) Horizontal (2D) Full Position (3D) DGPS Reference Clock Hold (2D) Overdetermined Clock
2	Disciplining Mode	UINT8	0 1 2 3 4 5 6	Normal Power-Up Auto Holdover Manual Holdover Recovery Not Used Disciplining disabled
3	Self-Survey Progress	UINT 8		0-100%
4-7	Holdover Duration	UINT 32		seconds
8-9	Critical Alarms	UINT16	bit field	Bit 0: ROM checksum error Bit 1: RAM check has failed Bit 2: Power supply failure Bit 3: FPGA check has failed Bit 4: Oscillator control voltage at rail
10-11	Minor Alarms	UINT16	bit field	Bit 0: Control voltage is near rail Bit 1: Antenna open Bit 2: Antenna shorted Bit 3: Not tracking satellites Bit 4: Not disciplining oscillator Bit 5: Survey-in progress Bit 6: No stored position Bit 7: Leap second pending Bit 8: In test mode
12	GPS Decoding Status	UINT8	0 1 3 8 9 0x0A 0x0B 0x0C 0x10	Doing fixes Don't have GPS time PDOP is too high No usable sats Only 1 usable sat Only 2 usable sats Only 3 usable sats The chosen sat is unusable TRAIM rejected the fix

Table A-89 Report Packet 0x8F-AC Data Format (Continued)

13	Disciplining Activity	UINT8	0	Phase locking
			1	Oscillator warming up
			2	Frequency locking
			3	Placing PPS
			4	Initializing loop filter
			5	Compensating OCXO
			6	Inactive
			7	Not used
			8	Recovery mode
14	Spare Status 1	UINT8	0	
15	Spare Status 2	UINT8	0	
16-19	PPS Offset	Single		Estimate of UTC/GPS offset (ns)
20-23	10 MHz Offset	Single		Estimate of UTC/GPS offset(ppb)
24-27	DAC Value	UINT32		Offset binary (0x00 - 0xFFFFF)
28-31	DAC Voltage	Single		Volts
32-35	Temperature	Single		degrees C
36-43	Latitude	Double		radians
44-51	Longitude	Double		radians
52-59	Altitude	Double		meters
60-67	Spare			Future expansion

A.11 Reference Documents

GPS - A Guide to the Next Utility

(Trimble 1990) An introduction to the GPS system in non-mathematical terms.

Global Positioning System Papers Published in Navigation

(Volumes I-III) Commonly known as "the redbooks".

Essential reading for the system engineer.

Global Positioning System Standard Positioning Service Signal Specification

Available at <http://www.navcen.uscg.gov>

B TSIP User's Guide

The GPS Tool Kit program disk includes several TSIP interface programs designed to help developers evaluate and integrate the GPS module and create GPS and differential GPS applications. These programs run on a PC-DOS platform. They are intended as a base upon which to build application specific software, so the source code in ANSI C is included for many of these programs. The GPS Tool Kit program disk includes the following programs:

TSIPCHAT.EXE: reads TSIP reports and prints them to the screen. It also allows the user to exercise TSIP commands, by translating keystroke codes into TSIP commands which are output over the serial port. When data input is required, TSIPCHAT prompts the user for the information. TSIPCHAT can also log TSIP reports in binary format, and can set time on a PC based on time information from THE GPS MODULE. SOURCE CODE IS PROVIDED.

TSIPPRNT.EXE: interprets a binary TSIP data stream, such as logged by TSIPCHAT, and prints it to a file. Source code is provided.

TCHAT.EXE: provides a good working basis for GPS development. Source code is provided. The program is Microsoft Visual C and Borland C compatible.

This appendix provides explicit instructions for each of the programs contained in the GPS Tool Kit, and guidelines for using the source code as template for integrated systems applications.

B.1 TSIP Terms/Definitions

TSIPCHAT	TSIPCHAT is a program that provides full visibility into the TSIP interface. Source code is provided. The source code (dual windows) requires a BORLAND C++ compiler.
-----------------	---

Starting TSIPCHAT

To start the program, type TSIPCHAT -C1 or TSIPCHAT -C2 for COM1 or COM2. the command line is: TSIPCHAT -Cx where 'x' is 1 for PC serial port COM1 or 2 for COM2. This choice can be changed while TSIPCHAT is running using the [CTRL] + [I] command.

As TSIPCHAT starts, it displays a list of commands in the upper half of the console screen (command window) and a running account of automatic (unrequested) reports in the bottom half of the screen (auto window). It also sets the serial port to the default settings of 9600 baud, 8-None-1.

If the receiver is alive and outputting positions, position reports scroll immediately in the auto window. If the auto window is empty, type 'v' to test if the receiver is connected properly to the computer. If the serial port is properly connected, the receiver responds within a second with the receiver software version numbers; otherwise “waiting for reply” remains on the screen.

Report Packets

When a TSIP report packet is issued by the receiver, it is received by TSIPCHAT, translated into a printable form and put on the screen. If the report packet has been specifically requested by a command, it is put in the command (upper) window; otherwise, it is reported in the auto (lower) window.

The common automatic reports are the navigation reports: position, velocity, and health data. The [CTRL] + [O] command can change the content of these auto-reports or turn them on and off. Other automatic reports include almanac, ephemeris status, and almanac health page when decoded; and receiver health, machine code status, and satellite selection at regular intervals.

Command Packets

TSIPCHAT uses keystroke codes to send TSIP Packet packets to the receiver. For instance, the keystroke [v] sends the TSIP Packet 0x1F, requesting a TSIP Report Packet 0x45 listing the software versions. A complete list of keystrokes and their associated TSIP commands can be called up by pressing the [?] key.

Many TSIP command packets require user-provided data or parameters. For instance, a request for a satellite almanac report packet requires the satellite identifier (SV PRN). In such cases, TSIPCHAT will prompt the user for inputs. For any of the following three type of prompts, pressing the [CTRL] + [Z] keys or [ESC] key aborts the whole command:

1. prompt for number: to enter a numerical value, type the value and hit [ENTER]. If no value is typed, the value entered will be 0.
2. prompt for selection: to select from a number of choices, cycle through the choices with the [SPACEBAR] and select with [ENTER]. An index 0 - 9 associated with the choice is shown in parentheses; this index can be typed in for direct access of the choice.
3. prompt for confirmation: to confirm when asked, type [Y] or [y]. Any other keystroke will be 'negative', including just the [ENTER] key.

Serial Port Control

To control the serial port settings on the data channel, Channel A of the ThunderBolt, use the TSIP 0xBB command.

To control the serial port settings on the computer, use the keystroke [CTRL] + [I] keys. This keystroke does not generate a TSIP packet, it prompts for the parameters for the buffered serial port. On start-up, the program automatically sets the port parameters to 9600 baud, 8-None-1. If the port parameters are changed from the default during the execution of TSIPCHAT, upon exit the program asks if the serial port is to be reset to the default.

File Storage

TSIPCHAT provides for file storage of a native binary TSIP stream. The native binary stream records the data coming off the serial port into a file. To turn data collection on and off, use the keystroke [CTRL] + [O]. The user has the option to append to a previously existing file. All report packet bytes are recorded into the file, whether translatable into packets or not. The exception is that using [ESC] to terminate the program exits gracefully, i.e. not record the partially-received packet at the end of the file. Using the plus (+) character does not terminate gracefully and records all bytes at the end. The recorded binary data stream is translated into an ASCII file with the program TSIPRNT.

**Quick-Start Almanac
Get and Load**

A stored almanac can allow the receiver to be “warm-started”, reducing time to first fix. If the receiver is started 'cold', with no almanac data in memory, it performs a search for satellites in the sky, which can take a few minutes. If the receiver has a recent almanac of satellite orbits, fixes begin within a minute. The receiver responds most quickly if loaded with time, frequency offset, last position, and a recent almanac. There is a command sequence for getting an almanac from the receiver and storing in a file named GPSALM.DAT, and a reverse command sequence for reading a file named GPSALM.DAT on the computer and loading it into the receiver. These command sequences use the Packet 0x38 and the Report Packet 0x58.

Use the exclamation point (!) for the get-and-store sequence, and the at symbol (@) for the read-and-load sequence. It is useful to record a fresh almanac every few days. A new almanac is available after the receiver has been operating continuously for about fifteen minutes. Check the health message to see that “Almanac not complete and current” is no longer reported before recording the almanac.

**Setting PC Time from
the Receiver**

TSIPCHAT includes the capability to set the PC clock to UTC time from the GPS satellite signal. (GPS time differs from UTC time by leap seconds.) The keystroke 'z' requests the time set Packet 0x21, (Report Packet 0x41). The first time the request is made during execution of the program, the user is prompted for the local time zone offset. The user time zone offset is '0' for UTC GMT; -5 for EST, -4 for EDT; -8 for PST, -7 for PDT; and positive numbers if ahead of (east of) GMT. Allowable range is 13 hours, plus or minus. The accuracy of this software method is approximately ± 0.5 seconds.

Exiting TSIPCHAT

To exit the program, hit the [ESC] key.

TSIPPRNT

TSIPPRNT translates TSIP report packet byte streams into readable reports. It uses the same report interface routines as TSIPCHAT, but uses 'printf' rather than 'cprintf' so that output can be redirected to a file.

The command line for console output is:

```
TSIPPRNT tsip_filename
```

where *tsip_filename* is the name of a stream of TSIP report packets collected directly from the receiver output port or from TSIPCHAT. The command line for re-directing output to a file is:

```
TSIPPRNT tsip_filename > ascii_filename
```

Full source code is provided. TSIPPRNT is created by compiling under any C compiler with the macro FILE_INPUT defined and with the include file TSIPINCL.H. The following routines must be compiled:

TSIPPRNT.C (main)

TSIP_RPT.C

TSIP_IFC.C

TSIPPRNT code can be easily modified by the user to supply any ASCII output file format that is required by adjusting the report interpreter routines in TSIP_RPT.C, provided the necessary information is contained in the binary input file. Software flow follows that of TSIPCHAT, except with no user-interactive and command features.

Serial Port Parameters

The default at start-up is 9600 baud, 8-none-1. The serial port parameters on the computer can be adjusted by typing '^I'. The program will prompt for new serial port parameters.

TCHAT

TCHAT is a simplified version of TSIPCHAT. TCHAT.C provides a good basis for GPS software development.

The command line syntax is:

```
TCHAT -c[port number] -f<optional  
file name>
```

where <optional file name> is the name where bytes received directly from the receiver will be collected.

Full source code is provided. Unlike TSIPCHAT, TCHAT can be compiled under both Microsoft and Borland Compilers. It uses the same source code modules as TSIPCHAT. The following modules comprise TCHAT:

```
TCHAT.C (main)  
TSIP_RPT.C  
TSIP_IFC.C  
SERIAL.C
```

Software flow follows the same as TSIPCHAT, except that the display and user interface has been greatly simplified. It is recommended that software developers become familiar with TCHAT before studying the source code to TSIPCHAT.

C Specifications and Drawings

This chapter provides the specifications and drawings for the ThunderBolt GPS Disciplined Clock.

C.1 Drawing

Figure C-1 ThunderBolt GPS Disciplined Clock dimensions

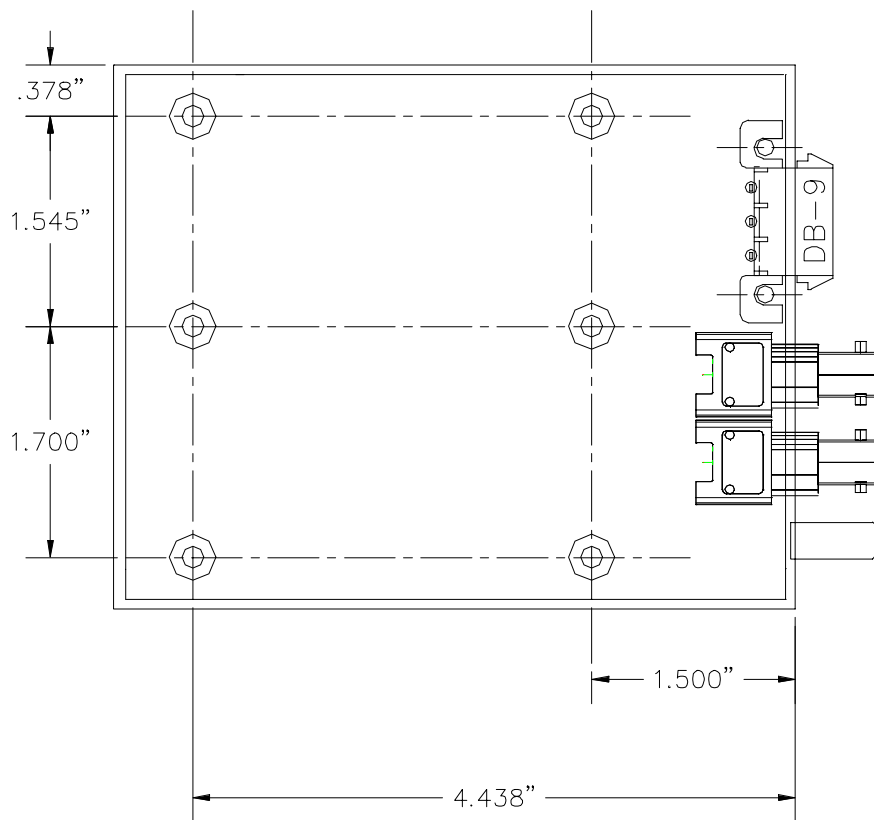

C.2 Specifications

Note – Specifications are subject to change without notice.

C.2.1 Performance Specifications:

General:	L1 frequency, CA/code (SPS), 8-channel continuous tracking receiver	
Update Rate:	1 Hz	
1 PPS accuracy:	GPS or UTC 20 nanoseconds (one sigma)	
Harmonic Level:	-40 dBc max	
Spurious:	-70 dBc max	
Phase Noise:	10 Hz	-120 dBc/Hz
	100 Hz	-135 dBc/Hz
	1 kHz	-135 dBc/Hz
	10 kHz	-145 dBc/Hz
	100 kHz	-145 dBc/Hz

C.2.2 Environmental Specifications:

Operating Temp:	-0°C to +60°C
Storage Temp:	-40°C to +85°C
Operating Humidity:	95% non-condensing
Maximum Altitude:	18,000 m

C.2.3 Interface Specifications:

Prime Power:	+24V return using DC-DC power supply (19-34v).
1 PPS:	BNC Connector TTL levels into 50 ohm 10 microseconds-wide pulse with the leading edge synchronized to GPS or UTC within 20 nanoseconds (one sigma) in static, time-only mode. The rising time is <20 nanoseconds and the pulse shape is affected by the distributed capacitance of the interface cable/circuit.
10 MHz:	BNC connector. Waveform is sinusoidal +12.5dBm, +/-2.5dBm into 50 ohms.
Serial Interface:	RS-232 through a DB-9 connector.

C.2.4 Physical Characteristics:

Power Consumption: 15 watts cold; 10 watts steady state

Dimensions: 5" L x 4" W x 2" H (127mm x 102mm x 51mm)

Weight: 20 oz. (567g)

Glossary

2-D	Two Dimensional. A 2-D position is defined as latitude and longitude. Altitude is assumed to be fixed.
2-D GPS mode	A procedure of determining a 2-D position using signals received from the best (or only) three available GPS satellites. Altitude is assumed to be known and constant. A 2-D position solution will only be determined if signals from three or more satellites are available.
2 dRMS	Twice the distance root mean, squared. The error distance within which 95% of the position solutions will fall.
3-D	Three Dimensional. A 3-D position is defined as latitude, longitude, and altitude.
3-D GPS mode	A procedure of determining a 3-D position using signals received from the best (or only) four available GPS satellites. A 3-D position solution will only be determined if signals from four or more satellites are available.
almanac	A reduced-precision subset of the ephemeris parameters. Used by the receiver to compute the elevation angle, azimuth angle, and estimated Doppler of the satellites. Each satellite broadcasts the almanac for all the satellites in the system.
ASCII	American Standard Code for Information Interchange. A standard set of 128 characters, symbols and control codes used for computer communications. ASCII characters require 7 bits of data to send, but are often sent 8 bits at a time with the extra bit being a zero.
asynchronous communication	A method of sending data in which the bits can be sent at random times. Data transmission is not synchronized to a clock. With asynchronous transmission, each character is transmitted one at a time with a “start” bit at the beginning and one or more “stop” bits at the end. Any amount of time can elapse before the next character is sent.
auto GPS mode	A procedure of automatically determining either a 2-D or 3-D position using signals received from GPS satellites. The solution automatically transitions between 2-D and 3-D depending on the number of satellites available, the PDOP of the available satellites, and the defined PDOP switch value. (See PDOP and PDOP constellation switch).
azimuth angle	The angle of the line-of-site vector, projected on the horizontal plane, measured clockwise from true North.

bandwidth	The range of frequencies occupied by a signal. Also, the information carrying capability of a communication channel or line.
baud	A measure of the speed of data transmission. Baud and bit rate are the same for direct equipment interconnections (e.g., via RS-232). Baud and bit rate are not the same for modulated data links, whether wire or radio.
bit	Binary digit. The smallest unit of information into which digital data can be subdivided and which a computer can hold. Each bit has only two values (e.g., on/off, one/zero, true/false).
bit rate	The rate at which bits are transmitted over a communication path. Normally expressed in bits per second (bps).
byte	A set of contiguous bits that make up a discrete item of information. A byte usually consists of a series of 8 bits, and represents one character.
C/A code	The Coarse/Acquisition code. This is the civilian code made available by the Department of Defense.
carrier	The radio signal on which information is carried. The carrier can be sensed to determine the presence of a signal.
channel	Either a single frequency or a pair of radio frequencies used as a communication path.
chip	The length of time to transmit either a zero or a one in a binary pulse code.
chip rate	Number of chips per second (e.g., C/A code = 1.023 MHz).
configuration	A set of conditions or parameters that define the structure of an item. A configuration defines the GPS processing and characteristics of the RS-232 interface ports. The term configuration can also define the hardware components that comprise a subsystem or system.
data bits	The bits in a byte of data which carry the actual information.
datum	Refers to a mathematical model of the earth. Many local datums model the earth for a small region: e.g., Tokyo datum, Alaska, NAD-27 (North America). Others, WGS-84, for example, model the whole earth.
DCE	Data Communications Equipment. The equipment that provides the functions required to establish, maintain, and terminate a communication connection. Any equipment that connects to DTE using an RS-232 or CCITT V.24 standard interface.
default setting	A preset or initial value that is assumed to be the preferred or appropriate selection for most situations. The ThunderBolt GPS sensor is shipped with factory default configuration settings; the settings were determined by Trimble Navigation.

dilution of precision	A description of the purely geometrical contribution to the uncertainty in a position fix, given by the expression $DOP = \sqrt{\text{TRACE}(A^{-1})}$ where A^{-1} is the design matrix for the instantaneous position solution (dependent on satellite-receiver geometry). The DOP factor depends on the parameters of the position-fix solution.
Doppler aiding	The use of Doppler carrier-phase measurements to smooth code-phase position measurements.
Doppler shift	The apparent change in frequency of a received signal due to the rate of change of the range between the transmitter and receiver.
earth-centered earth-fixed	Cartesian coordinate system where the X direction is the intersection of the prime meridian (Greenwich) with the equator. The vectors rotate with the earth. Z is the direction of the spin axis.
elevation angle	The angle between the line of sight vector and the horizontal plane.
elevation mask angle	A measure of the minimum elevation angle, above the horizon, above which a GPS satellite must be located before the signals from the satellite will be used to compute a GPS location solution. Satellites below the elevation angle are considered unusable. The elevation mask angle is used to prevent the GPS receiver from computing position solutions using satellites which are likely to be obscured by buildings or mountains.
ellipsoid	In geodesy, unless otherwise specified, a mathematical figure formed by revolving an ellipse about its minor axis. It is often used interchangeably with spheroid. Two quantities define an ellipsoid; these are usually given as the length of the semi-major axis, a , and the flattening, $f = (a - b)/a$, where b is the length of the semi-minor axis.
ephemeris	A set of parameters that describe the satellite orbit very accurately. It is used by the receiver to compute the position of the satellite. This information is broadcast by the satellites.
epoch	Measurement interval or data frequency, as in making observations every 15 seconds. Loading data using 30-second epochs means loading every other measurement.
firmware	A set of software computer/processor instructions that are permanently or semi-permanently resident in read-only memory.
frequency	The number of vibrations per second of an audio or radio signal. Measured in hertz (Hz), kilohertz (kHz), or megahertz (MHz). GPS frequencies are: L1 = 1575.42 MHz L2 = 1227.60 MHz

GDOP	Geometric Dilution of Precision. GDOP describes how much an uncertainty in pseudo-range and time affects the uncertainty in a position solution. GDOP depends on where the satellites are relative to the GPS receiver and on GPS clock offsets. PDOPPosition (three coordinates) HDOPHorizontal (two horizontal coordinates) VDOPVertical (height only) TDOPTime (clock offset only) RDOPRelative (normalized to 60 seconds)
geodetic datum	A mathematical model designed to best fit part or all of the geoid. It is defined by an ellipsoid and the relationship between the ellipsoid and a point on the topographic surface established as the origin of datum. This relationship can be defined by six quantities, generally (but not necessarily) the geodetic latitude, longitude, and the height of the origin, the two components of the deflection of the vertical at the origin, and the geodetic azimuth of a line from the origin to some other point. The GPS uses WGS-84.
geoid	The actual physical shape of the earth which is hard to describe mathematically because of the local surface irregularities and sea-land variations. In geodetic terms it is the particular equipotential surface which coincides with mean sea level, and which may be imagined to extend through the continents. This surface is everywhere perpendicular to the force of gravity.
GPS	Global Positioning System. A constellation of 24 radio navigation (not communication) satellites which transmit signals used (by GPS receivers) to determine precise location (position, velocity, and time) solutions. GPS signals are available world-wide, 24 hours a day, in all weather conditions. This system also includes 5 monitor ground stations, 1 master control ground station, and 3 upload ground stations.
GPS antenna	An antenna designed to receive GPS radio navigation signals.
GPS processor	An electronic device that interprets the GPS radio navigation signals (received by a GPS antenna) and determines a location solution. The GPS processor may also be able to apply (and determine) differential GPS corrections.
GPS receiver	The combination of a GPS antenna and a GPS processor.
GPS time	The length of the second is fixed and is determined by primary atomic frequency standards. Leap-seconds are not used, as they are in UTC. Therefore, GPS time and UTC differ by a variable whole number of seconds.
HDOP	Horizontal Dilution of Precision.
HOW	Handover Word. The word in the GPS message that contains time synchronization information for the transfer from C/A to P-code.

interface cable	The interface cable allows data to flow between the ThunderBolt and the communication equipment.
interference	Refers to the unwanted occurrences on communication channels that are a result of natural or man-made noises and signals, not properly a part of the signals being transmitted or received.
integrated Doppler IODE	A measurement of Doppler shift frequency or phase over time. Issue Of Data, Ephemeris. Part of the navigation data. It is the issue number of the ephemeris information. A new ephemeris is available usually on the hour. Especially important for Differential GPS operation that the IODE change is tracked at both the reference station and mobile stations.
jamming	Interference (in either transmitting or receiving signals) caused by other radio signals at exactly or approximately the same frequency
Kalman filter	A numerical method used to track a time-varying signal in the presence of noise. If the signal can be characterized by some number of parameters that vary slowly with time, then Kalman filtering can be used to tell how incoming raw measurements should be processed to best estimate those parameters as a function of time.
masks	See <i>satellite masks</i> .
maximum PDOP	A measure of the maximum Position Dilution of Precision (PDOP) that is acceptable in order for the GPS processor to determine a location solution (see PDOP).
NAVSTAR	The name given to the GPS satellites, built by Rockwell International, which is an acronym formed from NAVigation System with Time And Ranging.
packet	An “envelope” for data, which contains addresses and error checking information as well as the data itself.
parity	A scheme for detecting certain errors in data transmission. Parity defines the condition (i.e., even or odd) of the number of items in a set (e.g., bits in a byte).
PDOP	Position Dilution of Precision. PDOP is a unitless figure of merit that describes how an uncertainty in pseudo-range affects position solutions.
PDOP constellation switch	A value, based on PDOP, that defines when the GPS receiver/processor should switch between 2-D and 3-D GPS modes. The PDOP constellation switch is only active when the GPS mode of operation is set to Auto.
PRN	Pseudo-random noise. Each GPS satellite generates its own distinctive PRN code, which is modulated onto each carrier. The PRN code serves as identification of the satellite, as a timing signal, and as a subcarrier for the navigation data.
protocol	A formal set of rules that describe a method of communication. The protocol governs the format and control of inputs and outputs.

pseudo-range	A measure of the range from the GPS antenna to a GPS satellite. Pseudo-range is obtained by multiplying the speed of light by the apparent transit time of the signal from the GPS satellite. Pseudo-range differs from actual range because the satellite and user clocks are offset from GPS time and because of propagation delays and other errors.
RAM	Random-Access Memory.
random-access memory	Memory in which information can be referred to in an arbitrary or random order. The contents of RAM are lost when the System Unit is turned off.
range	A term used to refer to the distance radio signals can travel before they must be received or repeated due to loss of signal strength, the curvature of the earth and the noise introduced because of moisture in the air surrounding the earth's surface.
range rate	The rate of change of range between the satellite and receiver. The range to a satellite changes due to satellite and observer motions. Range rate is determined by measuring the Doppler shift of the satellite beacon carrier.
read-only memory	Memory whose contents can be read, but not changed. Information is placed into ROM only once. The contents of ROM are not erased when the system unit's power is turned off.
relative positioning	The process of determining the vector distance between two points and the coordinates of one spot relative to another. This technique yields GPS positions with greater precision than a single point positioning mode can
rise/set time	Refers to the period during which a satellite is visible; i.e., has an elevation angle that is above the elevation mask. A satellite is said to "rise" when its elevation angle exceeds the mask and "set" when the elevation drops below the mask.
ROM	Read-Only Memory.
RS-232	A communication standard for digital data. Specifies a number of signal and control lines. RS-232 is often associated with a 25 pin connector called a DB-25.
satellite masks	As satellites approach the horizon, their signals can become weak and distorted, preventing the receiver from gathering accurate data. Satellite masks enable you to establish criteria for using satellite data in a position solution. There are three types of satellite masks: Elevation, SNR, and PDOP.
SEP	Spherical Error Probability. The radius of a sphere such that 50% of the position estimates will fall within the surface of the sphere.
serial communication	A system of sending bits of data on a single channel one after the other, rather than simultaneously.

serial port	A port in which each bit of information is brought in/out on a single channel. Serial ports are designed for devices that receive data one bit at a time.
signal to noise level	GPS signals with SNRs that do not meet the mask criteria are considered unusable.
signal to noise ratio	A measure of the relative power levels of a communication signal and noise on a data line. SNR is expressed in decibels (dB).
SNR	Signal to Noise Ratio.
spread spectrum	The received GPS signal is a wide bandwidth, low-power signal (-160 dBW). This property results from modulating the L-band signal with a PRN code in order to spread the signal energy over a bandwidth which is much greater than the signal information bandwidth. This is done to provide the ability to receive all satellites unambiguously and to provide some resistance to noise and multi-path.
SPS	Standard Positioning Service. Refers to the GPS as available to the authorized user.
start bit	In asynchronous transmission, the start bit is appended to the beginning of a character so that the bit sync and character sync can occur at the receiver equipment.
stop bit	In asynchronous transmission, the stop bit is appended to the end of each character. It sets the receiving hardware to a condition where it looks for the start bit of a new character.
SV	Space Vehicle (GPS satellite).
synchronous communication	A method of sending digital data in which the bits come at fixed, rather than random, times and are synchronized to a clock.
TSIP	Trimble Standard Interface Protocol. Used by a large number of Trimble sensors. TSIP is the subset of TANS which is recognized by all Trimble sensors except the 4000 series. The TSIP protocol is defined in full in Appendix A.
URA	Satellite user range accuracy. The URA is sent by the satellite and is computed by the GPS operators. It is a statistical indicator of the contribution of the apparent clock and ephemeris prediction accuracies to the ranging accuracies obtainable with a specific satellite based on historical data.
UTC	Universal Coordinated Time. Uniform atomic time system/standard that is maintained by the US Naval Observatory. UTC defines the local solar mean time at the Greenwich Meridian.
UTC offset	The difference between GPS time and UTC time. UTC time = GPS time - UTC offset.

Index

Numerics

- 1 PPS C-2
- 1 PPS accuracy C-2
- 10 MHz C-2
- 10 MHz accuracy C-2
- 10 MHz frequency output 2-9
- 1D Timing mode 5-9
- 2-D position calculation 1-3
- 3-D position calculation 1-3

A

- acquiring GPS satellites 5-9
- Allan Variance 5-6
 - for GPS 5-7
 - with GPS 5-7
- almanac B-2
- almanac health page B-2
- Almanac not complete and current B-4
- antenna cables 3-5
- antenna movement 2-10
- antennas 1-2
- atomic clock 5-8
- attach the adapter cable 2-4
- attach the EZF connector 2-4
- attaching the EZF connector 2-5
- auto window B-2
- auto-survey or self-survey 2-9
- average position fixes 2-9

B

- base week 5-9
- bias and bias rate 1-1
- binary interface 1-1
- BNC Connector C-2
- BORLAND C compiler B-1
- Bullet Antenna 1-2
- Bullet Antenna specifications 3-8

C

- cable 1-2
- cable delay 5-9
- cable delay compensation 2-8
- cable jacket 2-4
- Cable Termination Kit 1-2
- cautions xix
- center conductor 2-4
- cesium 5-8
- clock correction 5-1
- clock-only mode 2-9
- clock-only solution 2-9
- Coarse/Acquisition (C/A) code 5-1
- coaxial cable 2-4
- Command Packets B-3
- computer connection 2-6
- Conditions Affecting Oscillator Performance 5-7
- constellation 5-1
- copyrights ii
- cost-effective 5-8
- crystal oscillators 5-8
- cut cable to desired length 2-4

D

- DB-9 connector 3-4
- default configuration 5-9
- delay 5-9
- determining placement 2-1
- dielectric layer 2-4
- dimensions C-3
- disclaimers ii
- distributed capacitance C-2
- document conventions xviii
- DoD 1-3
- down-converting of the GPS signal 1-1

E

- EEPROM 2-10
- environmental specifications C-2

ephemeris status B-2
Equator 2-1
Exiting TSIPCHAT B-4
expose the center conductor 2-4
EZF cable connector
 assembly 2-5
 cassette 2-5
EZF Connector Kit Instruction 2-3

F

fast performance 5-4
file storage B-3
firmware upgrades 4-1
frame 5-1
Full source code B-5

G

get-and-store sequence B-4
Global Positioning System 1-3
GPS + Oscillator 5-7
GPS applications 1-3
GPS board 1-1
GPS constellation 5-8
GPS control segment 5-8
GPS disciplined clock applications 5-8
GPS disciplined clocks 1-1
GPS module 2-10
GPS output 5-7
GPS satellite 5-8
 orbits 2-3
GPS system almanac 5-1
GPS time 5-8
 accuracy 5-8
GPS Timing 5-8
GPS Tool Kit program disk B-1
GPSALM.DAT B-4
ground-based control stations 5-1

H

Harmonic Level C-2
host control 5-9
host system 2-9

I

integer number of seconds 5-9
Interface Connector Pin-Out Table 3-4

interface specifications C-2
ionospheric data 5-1

J

jamming 1-2

K

keystroke codes B-3

L

L1 carrier frequency (1575.42 MHz). 5-1
leap seconds 5-9

M

maintenance 2-10
maximum view of the sky 2-1
memory 5-1
mount the antenna 2-4
mounting standoffs 2-1

N

National Institute of Science and Technology 5-9
navigation reports B-2
new position 2-10
notes xix

O

official UTC time 5-9
operating humidity C-2
operating temperature C-2
operations 5-1
orbital information 5-1
oscillator performance 5-4
 versus time 5-6
oscillators, basic characteristics 5-4
output 5-9
output packets 2-8
ovenized oscillator 5-7
ovenized quartz oscillator 1-1
over-determined 1D Timing mode 5-9

P

Packet 0x38 B-4
 Packet 31 2-10
 Packet 31 (XYZ ECEF) 2-10
 Packet 32 2-10
 Packet 32 (Latitude, Longitude, Altitude) 2-10
 Packet 8E-45 2-10
 Packet 8E-4B 2-9
 Packet 8F-0B 2-10
 Packet 8F-0B (Comprehensive Time) 2-8
 Packet 8F-A2 (Timing Status Detail) 2-8
 parsing packets 4-2
 PC clock B-4
 PC-DOS platform B-1
 periodic outputs 2-9
 Phase Noise C-2
 Physical Characteristics C-3
 position fix 5-9
 power 2-6
 power consumption 3-7, 3-3
 power loss 2-10
 power on 2-9
 power supply 1-1, 3-7
 PPS 1-1, 5-9
 PPS signal 2-9
 pre-amp 2-4
 prepare the cable for the EZF connector 2-4
 preparing rooftop antenna cable and connector 2-4
 preparing the antenna cable 2-3
 Prime power 3-8, C-2
 pseudo-random number 5-1

Q

Quartz performance 5-7
 Quick-Start Almanac Get and Load B-4

R

random walk 5-5, 5-6
 random walk phase 5-8
 read-and-load sequence B-4
 reference frequency 1-1
 reference position 2-9, 5-9
 reference position cleared 2-10
 Reference Signal 1-2
 Report Packet 0x58 B-4
 Report Packets B-2
 revision notice ii
 RF chip 1-2

RG-59 cable 3-5
 specifications 3-5
 RG-8 cable 3-5
 rising time C-2
 route the antenna cable 2-4
 Routing/Securing Cable 3-7
 RS-232C serial port 3-4

S

satellite almanac 5-1
 satellite data 5-1
 satellite density 2-3
 satellite ephemeris 5-1
 satellite identifier B-3
 satellite ranging 3
 self-survey 1-9
 self-survey mode 1-1, 1-2, 2-6
 Serial Interface C-2
 serial port B-2
 control B-3
 parameters B-5
 service loop 3-7
 Setting PC Time from the Receiver B-4
 shield 2-4
 Signal Integrity 1-2
 sine wave 5-4
 slow performance 5-4
 Smart Antenna II HE 5-1
 Software flow B-6
 software interface 4-1
 source code B-1
 special system messages 5-1
 specifications C-2
 spurious C-2
 Starter Kit 1-2
 Starting TSIPCHAT B-2
 static reference position 2-9
 static timing 5-9
 steady state 3-7
 steering algorithm 5-8
 steering voltage 5-8
 storage temperature C-2
 storing the reference position from the auto-survey
 procedure 2-10
 support xviii
 survey period 2-9
 SV PRN B-3
 synchronization applications 5-9
 synchronizing between wireless base stations 5-8
 System Architecture 5-12

T

TCHAT B-6
TCHAT.EXE B-1
technical assistance xviii
technical support xviii
Thunderbolt Clock components 3-1
Thunderbolt Clock Module 3-2
Thunderbolt
 automation 5-9
 overview 1-1
 setup 2-1
time and frequency 1-1
time required to transmit 5-1
time solution 2-9
timing accuracy 5-9
Timing Between Sites 5-8
Timing Operation 5-9
Timing Pulse Output 5-10
tips xix
tool kit B-1
trademarks ii
T-RAIM 1-2
T-RAIM algorithm 5-9
TSIP tool kit B-1
TSIP User's Guide B-1
TSIPCHAT B-1
TSIPCHAT.EXE B-1
TSIPPRNT B-3, B-5
TSIPPRNT.EXE B-1

U

update rate C-2
US Naval Observatory 5-9
UTC time 5-8, B-4
UTC vs. GTS Time 5-9

V

validity 5-1
variations 5-6
view of the sky 2-1

W

waiting for reply B-2
warm-started B-4
warnings xix
Waveform C-2
weight C-3

white noise error 5-4

Z

zero cable delay 5-9